

SNA6000A Series

Vector Network Analyzer

User Manual

EN02A



Content

Content	1
1 Copyright	10
2 Safety Requirement	11
2.1 Safety terms and symbols	11
2.2 Operating environment	12
2.3 Cooling requirement	13
2.4 AC power supply	13
2.5 Power supply and grounding	13
2.6 Calibration	14
2.7 Cleaning	14
2.8 Exceptional conditions	14
3 Product Introduction	15
3.1 General Description	15
3.2 Features	15
4 User Manual Overview	17
5 Quick Start	19
5.1 Dimensions	19
5.2 Power supply	20
5.3 Front panel	21
5.3.1 Power switch	24
5.3.2 RF connectors	25
5.4 Rear and side panels	26
5.5 OCXO option installation guide	29
5.6 User interface	31
5.6.1 Active entry	32
5.6.2 Value of marker	32
5.6.3 Trace State	32
5.6.4 Channel State	33
5.6.5 Hardkeys	33
5.6.6 Function Keys	33
5.6.7 Label Page	34
5.6.8 Window State	34
5.6.9 Stimulus Range	34
5.6.10 Status Bar	34
5.6.11 Message Bar	35

5.6.12	Graffiti Function	35
5.6.13	Theme Management	38
5.7	Touch Screen	42
5.8	Help Information	42
6	Set Up a Measurement	43
6.1	Measurement Classes	43
6.2	Measurement parameters	44
6.2.1	S parameters	44
6.2.2	Balanced Measurement	45
6.2.3	Receiver Measurement	53
6.2.4	Wave (Receivers notation)	53
6.2.5	Ratio	55
6.3	Frequency range	55
6.3.1	Set the frequency range	55
6.3.2	CW time sweep or power sweep	56
6.3.3	Frequency resolution	57
6.4	Power level	57
6.4.1	Coupled port power	57
6.4.2	Power Leveling and Offsets overview	58
6.4.3	Power Offsets and Limits setting	58
6.5	Sweep	59
6.5.1	Points	59
6.5.2	Sweep type	60
6.6	Trigger	63
6.6.1	Trigger Settings	63
6.6.2	Trigger source	64
6.6.3	Trigger Range	64
6.6.4	Channel Settings	65
6.6.5	Trigger mode	65
6.6.6	External and auxiliary triggers	67
6.7	Data format	70
6.7.1	Display format	70
6.7.2	Cartesian coordinates display format	70
6.7.3	Polar coordinates	72
6.7.4	Smith circle diagram	73
6.8	Scale	75
6.8.1	Scale/reference level and position	75
6.8.2	Scaling coupling	76
6.8.3	Electrical delay	78

6.8.4	Amplitude offset and amplitude slope	78
6.8.5	Phase deviation.....	79
6.8.6	Divisions	79
6.8.7	Scale type.....	80
6.9	Avg BW.....	80
6.9.1	Overview	80
6.9.2	Averaging	81
6.9.3	IF Bandwidth	81
6.9.4	Smoothing	83
6.10	Preset instructions.....	83
7	Measurement Calibration	86
7.1	Overview.....	86
7.2	Calibration type.....	87
7.3	Checking Calibration Status	90
7.3.1	Execution Status of Error Correction for Each Channel	90
7.3.2	Execution Status of Error Correction for Each Trace	92
7.3.3	Acquisition Status of Calibration Coefficient for Each Channel	92
7.3.4	Procedure to turn on/off calibration property display	93
7.4	Basic Cal.....	94
7.4.1	Open Response Calibration	96
7.4.2	Short circuit response calibration	97
7.4.3	Full 1 port OSL calibration.....	98
7.4.4	Transmission response calibration (two ports)	99
7.4.5	Enhanced response calibration (two ports).....	100
7.4.6	SOLT calibration (two ports).....	100
7.4.7	SOLR unknown through calibration (two ports)	102
7.4.8	TRL Direct Reflection Transmission Line Calibration (Two Ports)	102
7.4.9	Partial Overwrite calibration	103
7.5	Cal Kit management.....	104
7.5.1	Overview	104
7.5.2	Connector Tab	105
7.5.3	Standards Tab	107
7.5.4	SOLT Tab.....	109
7.5.5	TRL Tab.....	110
7.5.6	Create a custom Cal Kit	113
7.6	Power Cal	117
7.6.1	Internal source power calibration	117
7.6.2	Receiver calibration.....	118
7.7	Port extension.....	119

7.7.1	Manual port extension	120
7.7.2	Automatic port extension.....	122
7.8	Fixture measurement function.....	123
7.8.1	Port match	123
7.8.2	Port impedance conversion.....	124
7.8.3	2-port de-embed.....	125
7.8.4	N-port embedding / de-embedding	126
7.8.5	Differential port match	127
7.8.6	Differential and common port impedance conversion.....	128
7.9	Adapter removal / insertion function.....	128
7.9.1	Adapter removal	129
7.9.2	Adapter insertion	130
7.10	Ecal.....	130
7.10.1	Ecal Overview.....	130
7.10.2	Ecal Config	131
7.10.3	Confidence Check	132
7.10.4	Orientation.....	133
7.10.5	Characterization	134
8	Data Analysis.....	136
8.1	Marker.....	136
8.1.1	Ordinary marker:	136
8.1.2	Reference marker:	136
8.1.3	Marker setting:.....	136
8.1.4	Marker Display	139
8.1.5	Marker function.....	139
8.2	Marker search function	140
8.2.1	Search domain	140
8.2.2	Max and min search.....	141
8.2.3	Peak search	141
8.2.4	Target search.....	142
8.2.5	Multi-peak search	143
8.2.6	Multi-target search	143
8.2.7	Tracking search.....	143
8.2.8	Bandwidth search.....	144
8.2.9	Notch search	144
8.3	Mathematical operation	145
8.4	Conversion.....	146
8.5	Equation editor	148
8.6	Trace statistics.....	157

8.7	Limit test	157
8.8	Point Limit test	160
8.9	Ripple limit test	162
8.10	Bandwidth limit test.....	164
8.11	Time domain	165
8.11.1	Transform	165
8.11.2	Gating.....	167
8.11.3	Window.....	169
8.11.4	Coupling	171
8.11.5	Marker	172
8.11.6	Advance	173
9	Save and Recall.....	175
10	Guide For the TDR Option.....	178
10.1	Overview.....	178
10.2	Open/Close/Preset TDR Option	179
10.3	TDR Setup Wizard.....	180
10.4	Calibration for TDR Option	181
10.4.1	Deskew.....	181
10.4.2	Deskew & Loss Compensation	182
10.5	TDR Channel Setup	183
10.5.1	DUT Topology.....	184
10.5.2	DUT Length	184
10.5.3	Stimulus Magnitude in Time Domain	185
10.5.4	Port Impedance	185
10.5.5	Velocity Factor & Dielectric Constant.....	186
10.5.6	Power Level.....	186
10.5.7	Average	186
10.5.8	IF Bandwidth	187
10.5.9	Trigger Mode	187
10.6	TDR Trace Setup.....	187
10.6.1	Select a Trace	187
10.6.2	Scale Management	188
10.6.3	Memory Trace Management	189
10.6.4	Measure Parameter & Format.....	189
10.6.5	Stimulus in Time Domain	190
10.6.6	Smoothing	191
10.6.7	Trace Allocation	191
10.6.8	Trace Setup Coupling.....	192

- 10.6.9 Time Domain Gating 192
- 10.6.10 DC Value 193
- 10.7 TDR Data Analysis & Output 193
 - 10.7.1 Marker Setup 194
 - 10.7.2 Rise Time Search 194
 - 10.7.3 Delta Time Search 194
 - 10.7.4 Peeling 195
 - 10.7.5 File & Data Output 195
- 10.8 Eye Diagram Simulation 196
 - 10.8.1 Overview 196
 - 10.8.2 Stimulus Bit Pattern 196
 - 10.8.3 Stimulus Signal Setup 198
 - 10.8.4 Eye Diagram Analysis 199
 - 10.8.5 Eye Diagram Scale Management 199
 - 10.8.6 Mask Test for Eye Diagram 200
 - 10.8.7 Jitter & Statistical Eye Diagram 200
- 10.9 TDR Advanced Waveform Function 202
 - 10.9.1 View point 202
 - 10.9.2 Emphasis/De-emphasis 202
 - 10.9.3 De-embedding 203
 - 10.9.4 Equalization 204
- 10.10 Hot TDR 206
 - 10.10.1 Overview 206
 - 10.10.2 Usage Guidelines 207
- 11 Guide For the SA Option 209**
 - 11.1 Overview 209
 - 11.2 User Interface 209
 - 11.3 Create a Spectrum Analysis Channel 210
 - 11.4 Spectrum Analyzer Settings 211
 - 11.4.1 SA Setting Tab 212
 - 11.4.2 SA Tab Processing setup 214
 - 11.4.3 Source Tab 216
 - 11.4.4 Advanced Tab 218
 - 11.4.5 Trace setup 220
 - 11.5 Spectrum Analysis measurement 222
 - 11.5.1 Marker → SA 222
 - 11.5.2 Channel Power 223
 - 11.5.3 ACPR 225
 - 11.5.4 Occupied BW 227

11.5.5	TOI.....	228
11.5.6	CNR.....	230
11.5.7	Spectrum Monitor.....	232
12	The Frequency Offset Mode.....	234
12.1	Overview.....	234
12.2	Frequency Offset Mode.....	234
12.2.1	Frequency Offset settings.....	235
13	Scalar Mixer Measurements(SMM Option).....	239
13.1	Create an SMM measurement.....	239
13.2	Configure the Scalar mixer setup.....	241
13.2.1	Sweep Tab-Mixer Measure Setup box.....	242
13.2.2	Power Tab-Mixer Measure Setup box.....	243
13.2.3	Mixer Frequency Tab-Mixer Measure Setup box.....	244
13.2.4	Mixer Setup Tab-Mixer Measure Setup box.....	247
13.3	Do the Source Power Cal of the SMM mode (optional).....	250
13.4	Do the Receiver Cal of the SMM mode (optional).....	250
13.5	Do the SMM Calibration.....	250
13.5.1	Overview.....	250
13.5.2	Procedure Using Mechanical Calibration Kit.....	251
13.5.3	Checking Calibration Status.....	252
14	Pulse Measurement (PM Option).....	253
14.1	Overview.....	253
14.2	Pulse Measurement Settings.....	254
14.2.1	Pulse Measurement.....	254
14.2.2	Pulse Timing.....	254
14.2.3	Properties.....	255
14.2.4	Measurement Timing.....	255
14.3	RF&IF Path Gain dialog.....	256
15	Material Measurement (MT Option).....	258
15.1	Overview.....	258
15.2	Create a MT Measurement.....	259
15.3	Configure the Material Measurement Setup.....	260
15.3.1	Preset Tab.....	260
15.3.2	Measurement Model Tab.....	263
15.3.3	Sample Holder Tab.....	264
15.3.4	Waveguide Gap Correction Tab.....	265
15.4	Waveguide TRL Calibration.....	266
15.5	Sample Measurement.....	269

- 15.5.1 Sample Installation269
- 15.5.2 Sample Electromagnetic Parameter Measurement269
- 16 External Switch Matrices (SWM Option)..... 273**
- 16.1 Overview..... 273
- 16.2 External Matrix switches Introduction..... 273
- 16.3 Matrix setup step 274
 - 16.3.1 Required equipment.....274
 - 16.3.2 Establish the physical connection274
 - 16.3.3 Define the RF configuration276
 - 16.3.4 Setting S Parameters278
 - 16.3.5 Calibrate and measure.....279
- 17 System setting..... 280**
- 17.1 System Configuration 281
 - 17.1.1 Firmware upgrade281
 - 17.1.2 File Browser281
 - 17.1.3 Date/Time setting281
 - 17.1.4 Screenshot setting282
 - 17.1.5 Screensaver282
 - 17.1.6 System language282
 - 17.1.7 Power282
- 17.2 Communication interface setting 283
 - 17.2.1 LAN Status283
 - 17.2.2 mDNS Setting.....283
 - 17.2.3 LXI283
 - 17.2.4 VNC Setting.....284
 - 17.2.5 Web Setting.....284
 - 17.2.6 GPIB.....284
 - 17.2.7 External Device284
- 17.3 Preset 285
- 17.4 Factory Reset 286
- 17.5 Help information 286
 - 17.5.1 Help and About.....286
 - 17.5.2 Message Setting287
 - 17.5.3 View Message287
- 17.6 Buzzer..... 287
- 17.7 Self-Test..... 287
 - 17.7.1 Key and touch screen test.....287
 - 17.7.2 Performance test.....288

17.8	Options	293
17.9	External Ports	293
18	Service and Support	294
18.1	Ordering and activating the options	294
18.2	Warranty overview	295
18.3	Contact SIGLENT	295

1 Copyright







- **SIGLENT TECHNOLOGIES CO., LTD** All Rights Reserved.
- **SIGLENT** is the registered trademark of **SIGLENT TECHNOLOGIES CO., LTD**.
- Information in this publication replaces all previously corresponding material.
- **SIGLENT** reserves the right to modify or change parts of or all the specifications or pricing policies at the company's sole decision.
- Any method of copying, extracting, or translating the contents of this manual is not allowed without the permission of **SIGLENT**.

2 Safety Requirement

This section contains information and warnings that must be observed to keep the instrument operating under the corresponding safety conditions. In addition to the safety precautions specified in this section, you also have to follow common safe operating procedures.

2.1 Safety terms and symbols

When the following terms or symbols appear on the front panel, rear panel, or this manual, it indicates particular attention should be paid.

	Indicates potential injuries or hazards that may happen.
	Indicates electric shock that may happen.
	Indicates measurement grounding
	Indicates safety grounding.
	This is a start/standby switch. Press the switch, the VNA will switch between the working state and the standby state. The switch could not power off the device, to completely power off the VNA, the power cord must be removed from the AC socket.
	Indicates "AC".
CAUTION	Indicates potential damages to the instrument or other property that may happen.
WARNING	Indicates potential injuries or hazards that may happen.

2.2 Operating environment

Use in a clean and dry indoor environment with an ambient temperature range from 0°C to 40°C.

Note: Direct sunlight, electric heaters, and other direct heat sources, should be considered when evaluating the ambient temperature.

	WARNING: Do not operate the VNA in an explosive, dusty or humid environment.
---	---

This instrument meets the EN 61010-1 standard, and has the following restrictions:

Installation (overvoltage) category: Class II (electric supply connector) and Class I (measure terminal)

Pollution level: Class II

Protection level: Class I

Note:

Installation (overvoltage) category Class II indicates the local supply level is suitable for equipment connected to the AC power supply.

Installation (overvoltage) category Class I indicates the signal levels suitable for terminals connected to the RF source.

Pollution level Class II indicates it only occurs in a dry and non-conductive environment, sometimes we should consider the temporary conductivity caused by concentration.

Protection level Class I indicates grounding equipment, it prevents electric shock by connecting the equipment to the ground wire.

	CAUTION: Do not apply excessive pressure or strike the surface of the touch screen.
---	--

	CAUTION: Do not exceed the maximum voltage marked on the front panel connectors.
---	---

2.3 Cooling requirement

This instrument is cooled through a built-in fan. To keep adequate ventilation, a gap of at least 15 cm should be left on both sides, as well as the front and rear panels of the instrument.



CAUTION: Do not block the vents located along the side and rear panel of the instrument.



CAUTION: Do not let any external objects enter the instrument through the vents.

2.4 AC power supply

The instrument accepts 100-240V, 50/60/400Hz AC power. The maximum power consumption is 90W with complete options.

Note: The instrument can operate within the following input ranges:

Voltage range:	90 - 264 Vrms	90 - 132 Vrms
Frequency range:	47 - 63 Hz	380 - 420 Hz

2.5 Power supply and grounding

The instrument has a three-terminal plug and an IEC320 (Type C13) standard connector for the input power and grounding connections. The grounding terminal on the socket is directly connected to the instrument shell. To prevent electric shock, the plug must be inserted into a well-grounded socket. Please use the power cord provided to connect the instrument to the power source.



WARNING: Danger of electric shock!

Disconnected or broken internal or external grounding wires will increase the risk of electric shock. It is strictly forbidden to destroy the protective grounding wire or safety grounding terminals.

The location of the instrument should be convenient to access the power supply. To completely power off the instrument, the power cord should be removed from the power socket of the instrument. When the instrument is idle for long durations, it is recommended to unplug the power cord from the AC socket.



CAUTION: The RF connector's shell on the front panel is connected to the instrument's shell, and then connected to the earth ground.

2.6 Calibration

The recommended calibration cycle is one year. Calibration should only be performed by qualified personnel.

2.7 Cleaning

Only a soft damp cloth without any chemical/corrosive substances can be used to clean the instrument. Do not clean or use the product in wet environments. To avoid electric shock, unplug the power cord from the AC socket before cleaning.



WARNING: Danger of electric shock!

Do not disassemble the instrument. Maintenance must be carried out by qualified personnel only.

2.8 Exceptional conditions

Use the instrument only for the purpose specified by the manufacturer. Do not use if the instrument has visible damage or has endured severe transportation vibration. If the device is suspected to be damaged, please disconnect the power cord and contact your local SIGLENT office. To operate the instrument correctly, all instructions and marks should be read carefully.



WARNING: Use of the instrument for purposes unspecified by the manufacturer may damage the instrument.

3 Product Introduction

3.1 General Description

The SNA6000A series of vector network analyzers includes the following models: SNA6022A, SNA6122A, SNA6024A, SNA6124A, SNA6032A, SNA6132A, SNA6034A, SNA6134A. That have a frequency range of 100kHz to 26.5GHz, which support 2/4-port scattering, differential, and time-domain parameter measurements. The SNA6000A series are ideal for determining the Q-factor, bandwidth, and insertion loss of a filter. They feature impedance conversion, movement of measurement plane, limit testing, ripple test, fixture simulation, and adapter removal / insertion adjustments. The VNAs have five sweep types: Linear-Frequency mode, Log-Frequency mode, Power-Sweep mode, CW-Time mode, and Segment-Sweep mode. They also support scattering-parameter correction of SOLT, SOLR, TRL, Response, and Enhanced Response for increased flexibility in R&D and manufacturing applications. The frequency range of each model is shown in the table below.

Model	Ports	Frequency range
SNA6022A	2	100kHz-13.5GHz
SNA6122A	2 (Including front panel jumper interface)	100kHz-13.5GHz
SNA6024A	4	100kHz-13.5GHz
SNA6124A	4 (Including front panel jumper interface)	100kHz-13.5GHz
SNA6032A	2	100kHz-26.5GHz
SNA6132A	2 (Including front panel jumper interface)	100kHz-26.5GHz
SNA6034A	4	100kHz-26.5GHz
SNA6134A	4 (Including front panel jumper interface)	100kHz-26.5GHz

3.2 Features

- ◆ Frequency range: 100 kHz-26.5GHz
- ◆ Ports: 2/4

- ◆ Frequency resolution: 1 Hz
- ◆ Level resolution: 0.05 dB
- ◆ Range of IFBW: 10 Hz-3 MHz
- ◆ Setting range of output level : -55 dBm ~ +10 dBm
- ◆ Dynamic range: 135 dB
- ◆ Trace noise: 0.003 dBrms, 0.05 rms
- ◆ Types of calibration:
Response calibration, Enhanced Response calibration, Full-one port calibration, Full-two port calibration, Full-three port calibration, Full-four port calibration, TRL calibration
- ◆ Types of measurement:
Scattering-parameter Measurement, Differential-parameter Measurement, Receiver Measurement, Time-Domain parameter analysis, Limit test, Ripple test, Impedance conversion, Fixture simulation, Adapter Removal/Insertion, Spectrum Analysis, Frequency Offset, Scalar Mixer Measurement, Pulse Measurement.
- ◆ Optional Bias-Tees
- ◆ Interface: LAN, USB Device, USB Host (USB-GPIB)
- ◆ Remote control:
SCPI / LabVIEW / IVI based on USB-TMC / VXI-11 / Socket / Telnet / Webserver.
- ◆ Touch control:
Multi Touch, Mouse, Keyboard
- ◆ 12.1-inch touch screen
- ◆ Video output: HDMI

4 User Manual Overview

Main Contents

Chapter1. Copyright

Chapter2. Safety Requirement

Chapter3. Product Introduction

This chapter introduces the characteristic index and function of vector network analysis.

Chapter4. User Manual Overview

This chapter introduces the chapters of the user manual.

Chapter5. Quick Start

This chapter introduces the appearance and size of the vector network analyzer, the basic operation of the front and rear panels, user interface, buttons, and touch screen.

Chapter6. Set Up a Measurement

This chapter describes the measurement function, sweeping trigger setting, and other functions of the vector network analyzer, and introduces the functions under each menu in detail.

Chapter7. Measurement Calibration

This chapter introduces the different calibration methods of S parameters, power calibration methods, test fixture, and other functions of vector network analyzer in detail.

Chapter8. Data Analysis

This chapter introduces the mathematical analysis function, including time-domain analysis, windows, coupling, markers, and other functions.

Chapter9. Save and Recall

This chapter introduces the data save and recall processes.

Chapter10. Guide For the TDR Option

This chapter introduces how to use the TDR option.

Chapter11. Guide For the SA Option

This chapter introduces how to use the SA option.

Chapter12. The Frequency Offset Mode

This chapter introduces the function of SNA Sources tune to frequencies that are different (offset) from the VNA Receivers.

Chapter13. Scalar Mixer Measurements(SMM Option)

This chapter introduces how to do the Scalar Mixer Measurement.

Chapter14. Pulse Measurement(PM Option)

This chapter introduces how to use pulse measurements to test some DUT that cannot be tested using continuous signals.

Chapter15. Material Measurement(MT Option)

This chapter introduces how to measure a material.

Chapter16. External Switch Matrices (SWM Option)

This chapter introduces how to use external matrix switch for multi-port expansion.

Chapter17. System setting

This chapter provides information about the system settings.

Chapter18. Service and Support

This chapter provides information about service and support.

5 Quick Start

5.1 Dimensions

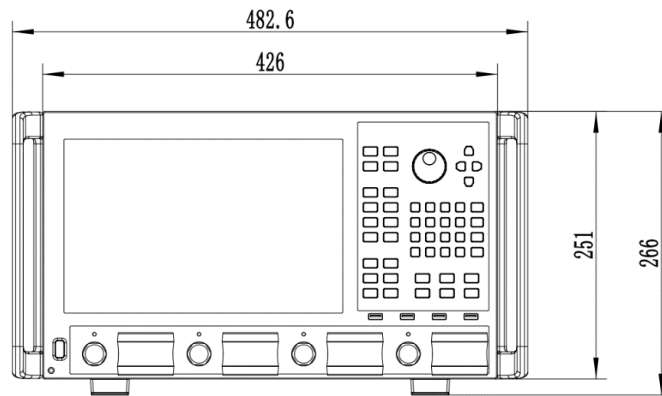

Figure 5-1 Front view

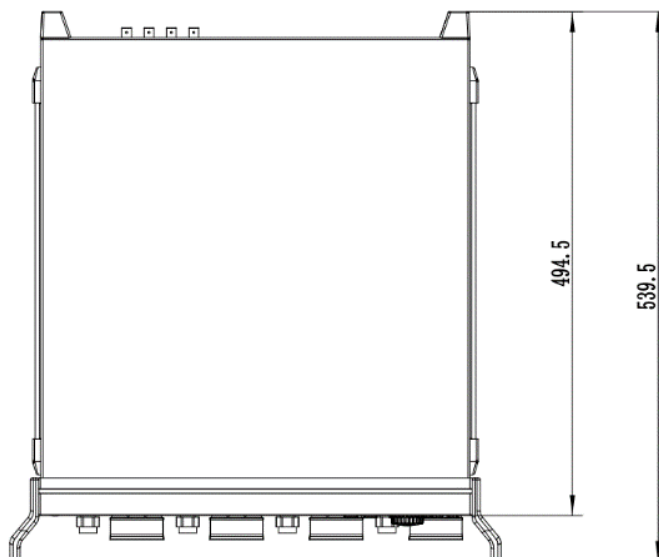

Figure 5-2 Vertical view

5.2 Power supply

The equipment accepts 100-240V, 50/60Hz AC power supplies. Please use the power cord provided to connect the instrument to the power source as shown in the figure below.



Figure 5-3 Power interface

5.3 Front panel



Figure 5-4 Front panel

Table 5-1 Front panel area description:

Number	Items	Description
A	LCD Touchscreen	12.1 inch TFT color capacitive LCD touchscreen. Notes: Avoid touching the LCD touchscreen with sharp objects. The effective pixel ratio of the screen is more than 99.998%, so it doesn't mean a fault when the screen has some black / blue / green / red fixed points less than 0.002%. Screen savers are not recommended. The LCD screen is unlikely to suffer from image burn-in.
B	Instrument	Prev: Make the previous trace/channel/window active. Next: Make the next trace/channel/window active. Trace: Call up the "Trace" function key menu to manage traces. Channel: Call up the "Channel" function key menu to manage channel.

C	Response	Meas: Set port S parameters, balance measurement, receive measurement, wave measurement, ratio measurement, and measurement mode.
		Format: Set the display methods for measurement parameters, such as Log Mag, Lin Mag, Smith, Polar, SWR, Phase, and other display methods.
		Marker: Set up markers for measuring parameters, making it easy to read the parameter measurement values at the specified frequency, and move the frequency at the cursor to the left, middle, and right of the screen, making the display results more intuitive.
		Math: Set measurement data to be stored in memory, perform mathematical operations on current and historical data, and display them. It can perform normalization operations on the data, perform time-domain transformation analysis on measurement results, and other functions.
		Scale: Set the display scale for testing measurement amplitude
		Cal: Calibrate the S parameters and power of the equipment.
		Search: Capture the maximum and minimum values of test parameters, measure the Q value, bandwidth, etc. of the filter.
		Avg BW: Average and smooth the test data, and set the intermediate frequency bandwidth of the receiver.
D	Stimulus	Start: Set the start frequency.
		Stop: Set the stop frequency.
		Freq: Set start,center,stop,span frequency, number of points, etc.
		Power: Set the power level of the port's transmission signal, output on/off, etc.
		Sweep: Set log frequency and linear frequency display methods, set number of points, sweep mode, sweep time, etc.
		Trigger: Set internal and external trigger source, set ext trig output on/off, and set hold, single, continuous trigger,and other methods.
E	Utility	System: Set the IP address of the device, display the system date time, set the language, and turn on or off the buzzer. Equipment

		self test, etc.
		Help: View help documents.
		Preset: Initialize the device and restore the settings changed during use.
		Display: Set the number of test windows and test traces.
		Save Recall: Store the setting conditions in a storage device, or read the calibration data and trace data of the analyzer from the storage device.
		Touch: The screen touch function is turned on and off.
F	Numeric	0-9: Selects values for measurement settings, then press Enter or G/n - M/u - k/m to complete the selection.
		decimal point: Enters a decimal point to designate fractions of a whole number.
		+/-: Plus - Minus Toggles between a positive and negative value entry if it is the first key pressed in the entry.
		T/p 、 G/n 、 M/u 、 k/m: Completes the value selection, assigning a unit of measurement. T/p (Tera/piko) E12 or E-12 G/n (Giga/Nano) E9 or E-9 M/u (Mega/micro) E6 or E-6 k/m (kilo/milli) E3 or E-3
		Esc: Close dialog boxes
		Back Space: Backspace. Move the cursor back and delete any previous selections.
		Tab: Switch touch screen focus
		Enter: Enters the values that you select for the measurement settings.
G	Navigation	Up/Down buttons: 1. When the focus is on the function key menu, press the up and down arrow keys to select the function key (the selected menu border is highlighted).

		<p>2. When the focus is on the data input area (the data input field is displayed in blue), pressing the up and down arrow keys will increase or decrease the numerical values in the data input area in large steps.</p> <p>Left/Right buttons: Move the cursor horizontally in the data input area</p>
H	Knob	<p>1. When the focus is on the function key menu (highlighted in blue on the menu border), turn the knob clockwise or counterclockwise to move the selection of the function key up and down.</p> <p>2. When the focus is on the data input area (the data input field is displayed in blue), turning the knob clockwise or counterclockwise increases or decreases the numerical value in the data input area in small steps.</p>
I	USB Hub	Includes four USB ports for data exchange and power supply with peripherals. The total current of four USB ports is less than 2A.
J	Test Ports	Connect to the DUT for signal transmission and reception.
K	Power Switch	Power on/off the equipment.
L	Support Foot	Support the stability analyzer. The screen divider can be adjusted appropriately for better operation and observation of the display screen.

5.3.1 Power switch

Stand-by is indicated by a constant orange-colored power switch.

A single button press will cause the light to turn white which indicates the instrument is operating.

Continuous white indicates the instrument is operating.

A short press of this button (one second) causes the light to turn orange which indicates the instrument is in the stand-by state after saving the settings.

A long press of this button (three seconds) will cause the light to turn orange which indicates the instrument is in the stand-by state immediately without saving the settings.

5.3.2 RF connectors

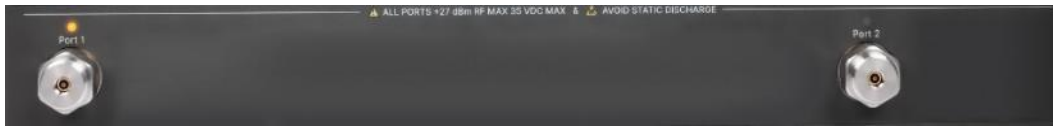

Figure 5-5 Front panel RF connectors (2-port VNA)



Figure 5-6 Front panel RF connectors (2-port VNA, Including jumper interface)



Figure 5-7 Front panel RF connectors (4-port VNA)



Figure 5-8 Front panel RF connectors (4-port VNA, Including jumper interface)

- The number of RF connectors is two or four, depending on the instrument configuration.
- The presence or absence of jumpers is determined by some specific measurement function options included with the network analyzer.
- When an RF connector is transmitting an RF signal, the corresponding orange light above the RF connector will be lit.
- Do not apply DC voltage or current to the test port, as applying DC voltage or current can cause equipment failure, especially when the capacitor remains charged. After fully discharging the vector network analyzer, connect the equipment to be tested to the test port. The maximum DC input limit of the test port is 35V, and the maximum RF input power is 27dBm. Ensure that static electricity is completely discharged from the human body and device components when operating the equipment.

5.4 Rear and side panels



Figure 5-9 Rear panel

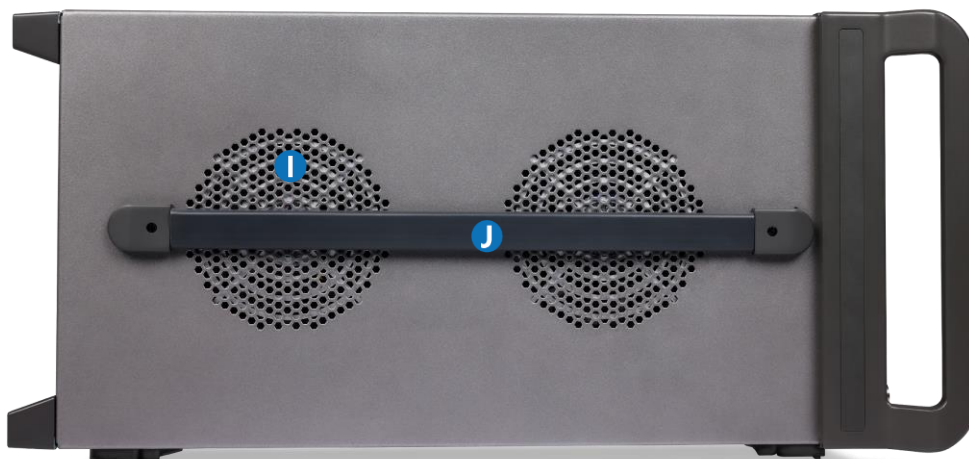

Figure 5-10 Side panel

Table 5-2 Rear and side panel area description:

Number	Items	Description
A	Power Input	To connect the equipment to the power supply, a three pin power cord with a grounding conductor provided must be used. When it is necessary to cut off the power supply to avoid danger such as electric shock, the power cord plug (located at the power socket or device end of the cord) must be unplugged. For the steps to turn off the main power supply for normal use, please refer to the instructions on the power switch.
B	OCXO	By selecting an OCXO constant temperature crystal oscillator with higher temperature coefficient and accuracy, a source output signal with better performance can be obtained.
C	I/O data interface	Used for transmitting data.
D	USB interface	Contains 1 USB device port for data exchange with external devices.
E	network interface	Connect the vector network analyzer to the LAN through a network cable, so that external devices such as PCs can access this device for information exchange. This 10/100Base-T network interface has a standard 8-pin configuration and automatic selection between two data rates.
	USB interface	Contains four USB 3.1 Gen 2 interface (H310 USB 3.1 Gen1)
	DVI /DP interface	For external display screens, 1x DVI-D: up to 1920x1200 @ 60Hz; 1x DP 1.2: up to 4096x2304 @ 60Hz.
	COM interface	The serial interface used to connect devices.
	HDMI interface	A terminal used to connect an external HDMI display device. By connecting the external display device to this terminal, the same information displayed on the host LCD touch screen can be displayed on an external color monitor.
	Audio interface	Audio input and output, Mic input, Audio Output.

F	TRIG IN	<p>When the vector network analyzer uses the external trigger signal for triggering, ExtTrig will be displayed on the status bar at the bottom of the device screen.</p> <p>Input power level:</p> <p>Low threshold voltage: 1.1 V</p> <p>High threshold voltage: 2.5 V</p> <p>Input level range: 0 to + 5 V</p> <p>Pulse width: $\geq 2\mu\text{s}$</p> <p>Polarity: Positive or negative</p>
	TRIG OUT	<p>This connector is used to output the internal trigger signal generated by the vector network analyzer, so that it can be used for triggering by other testing devices.</p> <p>maximum output current: 20 mA</p> <p>Output power level:</p> <p>Low level voltage: 0 V</p> <p>High level voltage: 3.3 V</p> <p>Pulse width: $1\mu\text{s}$</p> <p>Polarity: Positive or negative</p>
	10MHz IN	<p>When a 10MHz external reference signal input is detected on this port, the signal will be used as a frequency reference for the vector network analyzer. The characteristic impedance of this port is $50\ \Omega$, the input frequency range is $10\text{MHz} \pm 10\text{ppm}$, and the input power range is -3dBm to $+10\text{dBm}$.</p> <p>Note: When a 10MHz external reference signal is input to this connector, the phase of the measurement signal output by the vector network analyzer will automatically lock to the reference signal. When the external input reference signal does not exist, the internal frequency reference signal of the vector network analyzer will be automatically used. When the phase of the signal transmitted by the system is locked to an external 10MHz</p>

		reference signal, the ExtRef on the status bar at the bottom of the device screen will be displayed in white. When it is not locked, a Ref Unlock message will be prompted.
	10MHz OUT	<p>This connector is used to output the internal 10MHz reference signal generated by the vector network analyzer, so that the reference signal can be used by other testing equipment. By connecting this connector to the external reference signal input connector of other devices, the phase of the signal emitted by the device can be locked onto the internal reference signal of the vector network analyzer, and can be used under this condition.</p> <p>The characteristic impedance of this port is 50 Ω, the output frequency range is 10MHz \pm 5ppm, and the output power range is -3dBm to +3dBm.</p>
G	DC bias input	<p>It contains four BNC connector, and the external voltage source is connected with this BNC connector, so that the DC voltage can enter the test cable connected to the active equipment to be tested such as amplifiers through this BNC connector, thus completing the power supply drive of the equipment to be tested.</p> <p>Note: Do not apply a DC voltage exceeding 35V, the DC current must be less than the rated current of the fuse.</p>
H	Fuse	DC biased protective fuse, maximum withstand current: 500 mA
I	Fan	A cooling fan used to control the internal temperature of the vector network analyzer, which can exhaust the hot air in the vector network analyzer and cool the equipment components.
J	Handle	Portable handle, convenient for equipment transportation and transfer.

5.5 OCXO option installation guide

1. After the vector network analyzer is powered off, use a screwdriver to remove the cover at the OCXO option located behind the vector network analyzer.

2. Insert the OCXO module into the slot of the entire machine and secure it to the rear housing with screws.
3. The vector network analyzer is powered on and the OCXO option can be used normally.



Figure 5-11 OCXO option installation guide

5.6 User interface

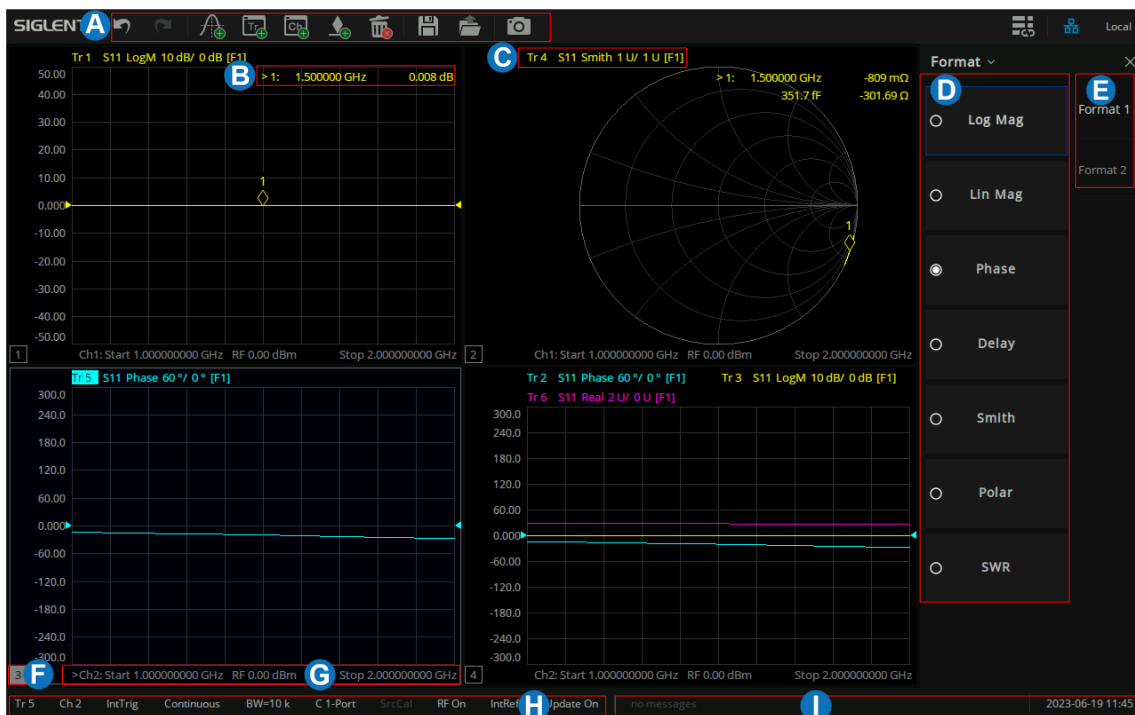











Figure 5-12 User interface

- A. **Active Entry** Adding, deleting, marking, and taking screenshots to mark readings and display information about marked points
- B. **Marker Readout** Display information about marked points
- C. **Trace Status** Display the current trace status
- D. **Soft Keys** Touch screen buttons
- E. **Soft tabs** Display parameter format
- F. **Window number** View current window
- G. **Stimulus Range** Display the set incentive conditions
- H. **Status Bar** Display trigger mode
- I. **Message Bar** Display date and error message

5.6.1 Active entry

Table 5-3 Active entry description:

Functions	Functions Description
	Recall the previous step.
	Recovering the withdrawn operation.
	Add a measurement trace.
	Add a measurement trace in a new window
	Add a measurement channel in a new window.
	Add a marker.
	Delete active window or trace. Note: Keep at least one trace on the interface.
	Save status, calibration data, and snp files, etc
	Load status, calibration data, and snp files, etc
	Screenshot

5.6.2 Value of marker

Display the frequency and reading of the marker.

5.6.3 Trace State

- A trace is a series of measured data points. Up to 256 traces can be created. In addition, one historical memory trace for each active trace can be stored and displayed. Mathematical operations can be performed on the current trace data and the historical memory trace.

- Press the **Display** button in the front panel, and the **Trace Setup** menu pops up on the right side of the screen to manage the operation Trace, such as adding a trace, deleting a trace, maximizing the trace window, moving traces between Windows, keeping the trace to the maximum or minimum value without displaying the current value, etc.
- Select a trace line and press the **Scale** button to change the reference electric equalization operation.

5.6.4 Channel State

- Channels contain traces. Up to 256 channels can be created. The channel setting determines how trace data is measured, and all traces assigned to a channel share the same channel setting.
- Press the **Display** button in the front panel, and the **Channel Setup** menu pops up on the right side of the screen. This can be used to manage operation channels, such as adding channels, copying channels, and deleting channels.

5.6.5 Hardkeys

Using Display Setup in the Display submenu, you can set Hardkeys and open the virtual keypad on the right side of the screen to operate the vector network analyzer without operating the function keys on the front panel.

5.6.6 Function Keys

Table 5-4 Function Keys Interface Description

Functions	Functions Description
Log Mag	Parameters are displayed in logarithmic amplitude mode.
Lin Mag	The parameters are displayed in amplitude linear fashion.
Phase	Displays the phase of the parameter.
Delay	Displays the delay of the parameter.
Smith	The parameters are shown in the form of a Smith chart.
Polar	The parameters are displayed in polar coordinates.
SWR	The parameters are shown in SWR.

5.6.7 Label Page

Displays all parameter display formats supported by the vector network analyzer.

5.6.8 Window State

- Windows can be used to view trace data and up to 100 windows can be created.
- Press the button of **Display** in the front panel and the **Window Setup** menu pops up on the right side of the screen. It can be used to manage operation windows, such as selecting a window, adding a window, deleting a window, maximizing a window, layout, and so on.

5.6.9 Stimulus Range

Displays the excitation signal set in the current window, including starting frequency, ending frequency, internal source output power, etc.

5.6.10 Status Bar

Table 5-5 Status Bar Interface Description

Functions	Functions Description
IntTrig	Displays the current trigger mode.
Continuous	Continuous trigger, single trigger, and other trigger mode displays.
BW=10k	Display of the current IF bandwidth.
C1·Port	S parameter calibration data state loading display.
SrcCal	Display whether the internal source power calibration data state is loaded or not. A Gray dark shaded label represents an unavailable selection/option.
RF On	Internal source output power ON and off, RF ON stands for ON.
IntRet	A display that currently uses an internal or external reference signal.
Update On	UI waveform update or not.

5.6.11 Message Bar

Displays the current date information and error information during testing.

5.6.12 Graffiti Function

This product provides a basic graffiti function, which is used to draw graphics and mark information on the main interface. This feature is great for annotating screenshots and adding important details before saving.

- **Graffiti function menu bar**

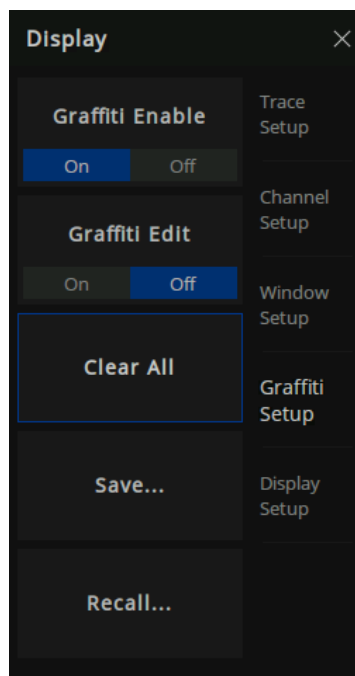

Figure 5-13 graffiti function menu bar

As shown in Figure 5-13, the graffiti menu contains functions of enable, edit, clear, save and call.

● **Graffiti Editing Interface**

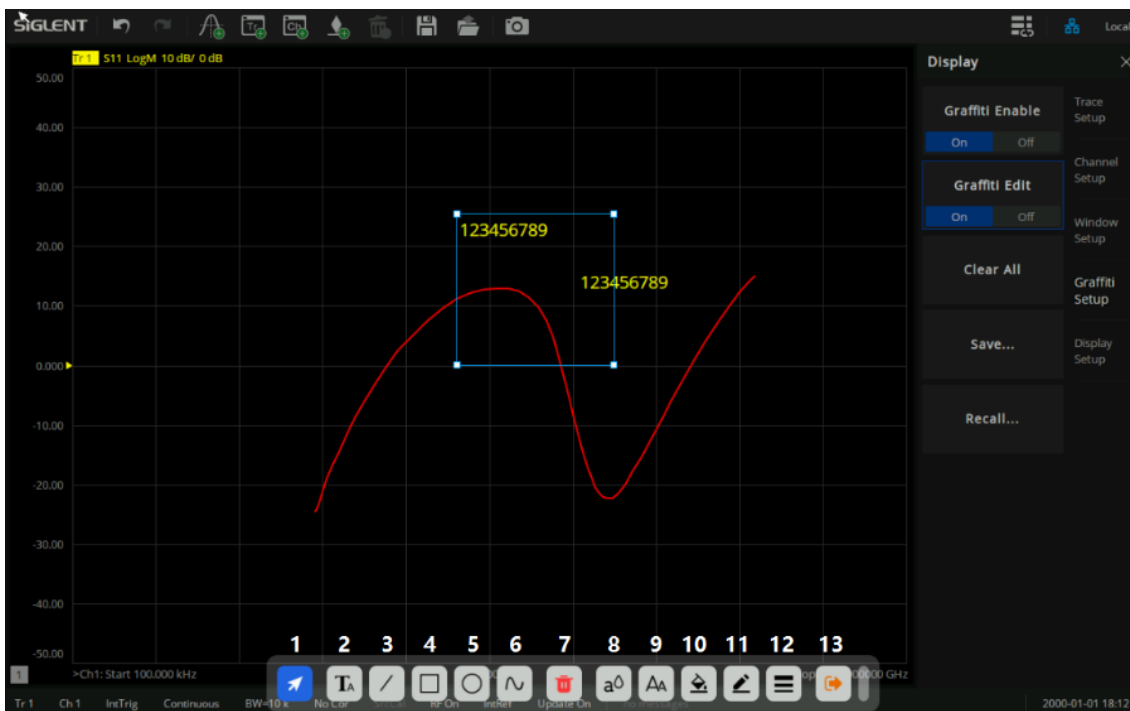

Figure 5-14 graffiti editing interface

As shown in Figure 5-14, the toolbar at the bottom of the interface displays a series of tools for graphic editing:

1. Selection tool: A series of editing can be carried out after the drawing is selected
2. Text tool: Add text notes in the interface
3. Line tool: Add a line in the interface
4. Rectangle tool: Add a rectangle to the interface
5. Ellipse tool: Add an ellipse to the interface
6. Curve tool: Draw a series of lines arbitrarily in the interface (double click the mouse/ double click the finger on the screen to finish drawing)
7. Delete tool: Delete the currently selected drawing
8. Text color tool: Set text color (support graphics: text)
9. Text size tool: Set text size (support graphics: text)
10. Background filling tool: Fill graphics background color (support graphics: text, rectangle, ellipse)
11. Border color tool: Set the border color of graphics (support graphics: text, line, rectangle, ellipse, curve)

12. Border line tool: Adjust the border line thickness of graphics (support graphics: text, line segment, rectangle, ellipse, curve)
13. Exit editing tool: Exit the current editing state

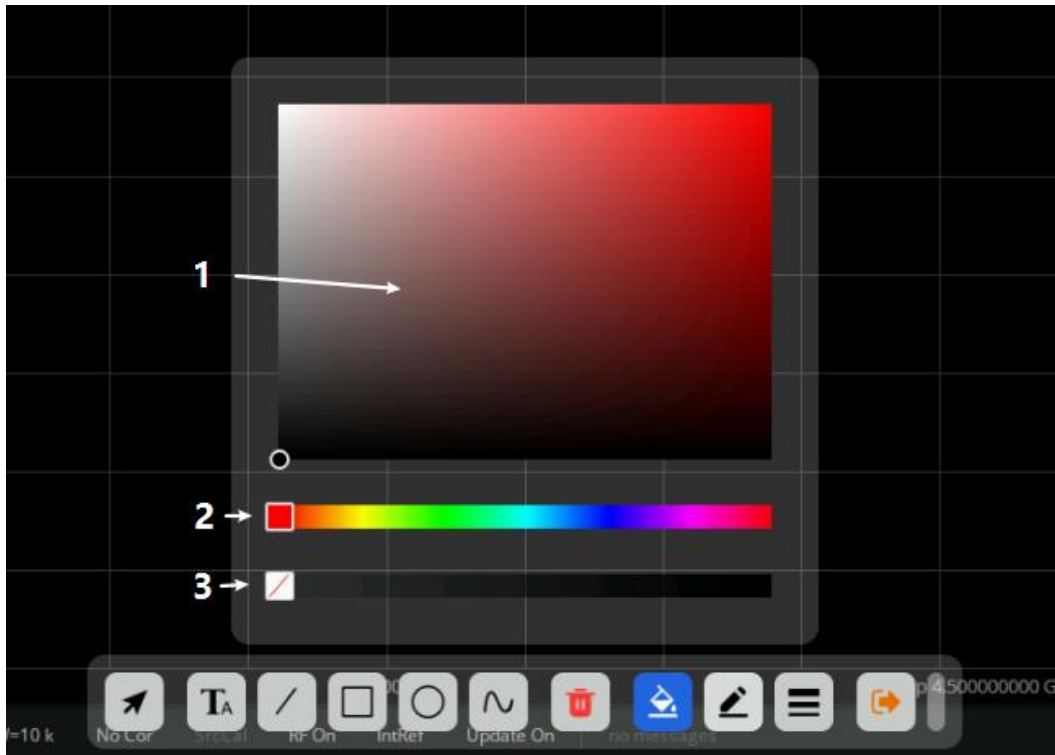

Figure 5-15 Color selection interface

As shown in Figure 5-15, after calling out this interface, you can adjust the corresponding colors of the graphics:

1. Color shade selection tool: Mouse/ finger click to select the appropriate brightness of the color
2. Color selection tool: Select a specific color
3. Color transparency tool: Adjust color transparency (the more right, the lower color transparency)

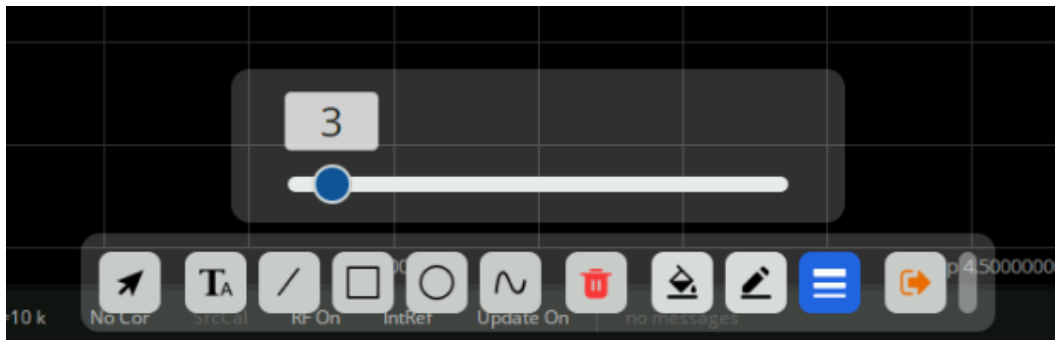

Figure 5-16 Line thickness adjustment interface

As shown in Figure 5-16, you can adjust the line thickness at the edge of the graph by calling out this interface. The larger the value is, the thicker the line will be.

- **Save/Recall**

Click the save menu button to save the current graffiti content as a file with *.GFT as the file extension.

5.6.13 Theme Management

In the "Theme Management" panel, instrument provides display configuration options for the measurement panel, allowing you to flexibly configure parameters such as trace color thickness, XY axis font style, and view grid style.

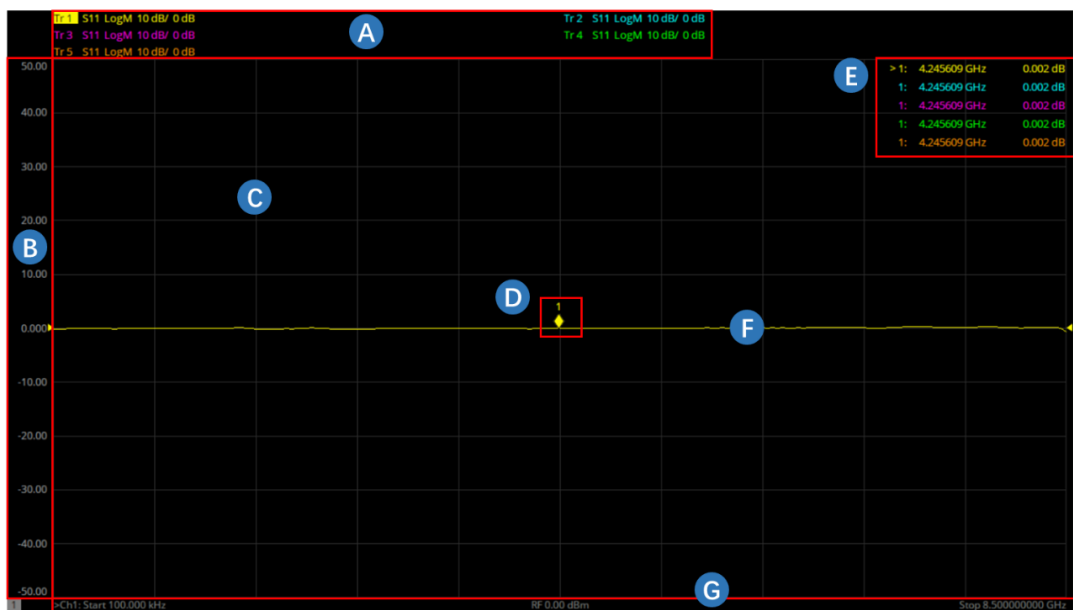

Figure 5-17 The Measurement Panel

- A. Trace Title Bar
- B. Response Axis/Left Axis

- C. Plot Grid
- D. Marker
- E. Marker Info Bar
- F. Trace Line
- G. Stimulus Axis/Bottom Axis

Press the “Display” button on the front panel → “View Settings” → “Theme Manager...” to enter the "Theme Management" panel. instrument supports importing and saving themes. Select a specific theme from the theme drop-down menu to configure the measurement panel display parameters in one step. After completing the new theme configuration, click "Copy..." and then set a new name to add the current theme to the theme drop-down menu. Click "Delete" to delete the current topic from the theme drop-down menu.

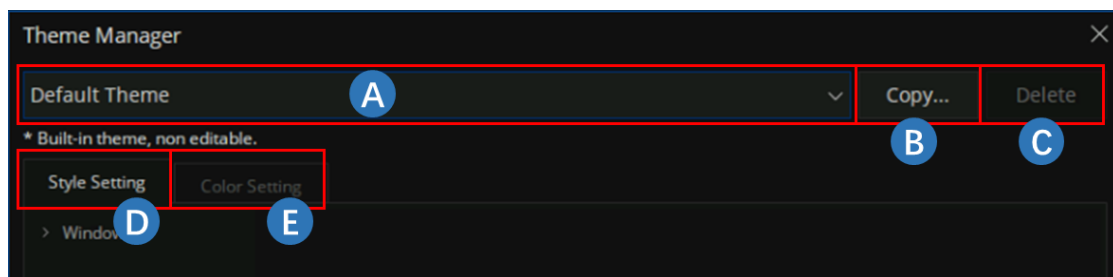

Figure 5-18 Theme Management Panel

- A. theme drop-down menu
- B. "Copy...", save current theme
- C. "Delete", delete current theme
- D. Style Settings
- E. Color Settings

5.6.13.1 Style Settings

Click on "Style Settings" to enter the style setting interface, with the following options:

5.6.13.1.1 Plot Grid

"Window" → "Plot Grid" to enter the plot grid style setting menu, where you can set the grid line style and width. The grid line style menu bar has five styles to choose from: solid, dash, dot, dash-dot, and dash-dot-dot.

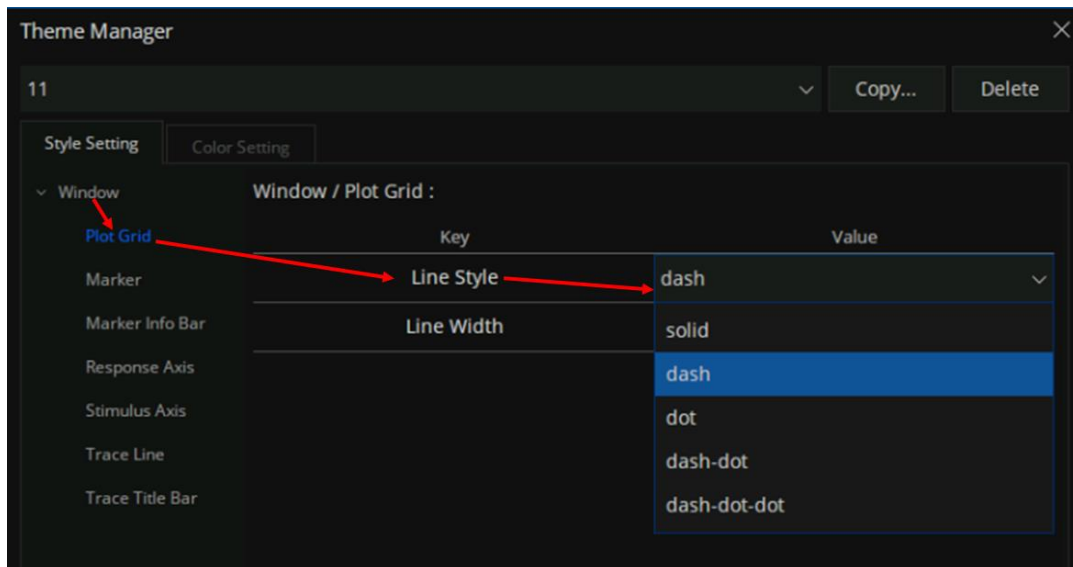

Figure 5-19 Choosing The Line Style With “dash” In The Plot Grid Menu

5.6.13.1.2 Marker

"Window" → "Marker" to enter the marker style setting menu, where you can set the font size, font style and font weight of the marker. The font style can be selected as normal or italic, and the font weight can be selected as normal or bold. The settings for font styles are the same below.

5.6.13.1.3 Marker Info Bar

"Window" → "Marker Info Bar" to enter the marker information bar style setting menu, where you can set the font size, font style, and font weight of the marker information bar.

5.6.13.1.4 Response Axis

"Window" → "Response Axis" to enter the response axis style setting menu, where you can set the font size, font style, and font weight of the response axis.

5.6.13.1.5 Stimulus Axis

"Window" → "Stimulus Axis" to enter the stimulus axis style setting menu, where you can set the font size, font style, and font weight of the stimulus axis.

5.6.13.1.6 Trace Line

"Window" → "Trace Line" to enter the trace line style setting menu, where you can set the trace line width.

5.6.13.1.7 Trace Title Bar

"Window" → "Trace Title Bar" to enter the trace title bar style setting menu, where you can set the maximum limit columns, minimum limit columns, maximum limit rows, font size, font style, and font weight.

5.6.13.2 Color Setting

Click on "Color Setting" to enter the color setting interface. In the interface, you can set the colors of current traces, historical memory traces, measurement window backgrounds, grid lines, axis text, and other objects. For the current trace and historical memory trace, you can choose eight colors each, corresponding to Trace1-8 and MemTrace1-8. If the number of traces is greater than 8, the color of the trace is Trace $x\% 8$, where x is the serial number of the trace.

Click on the color box on the right, and the "Color Picker" interface will pop up. You can set the desired color by moving the color panel circle and color axis ruler.

instrument supports importing and exporting color configuration files. Click on "Import" on the bottom right side and select the corresponding file to complete the color configuration in one step; Click on "Export", select the save path and set the file name to save your current color configuration.

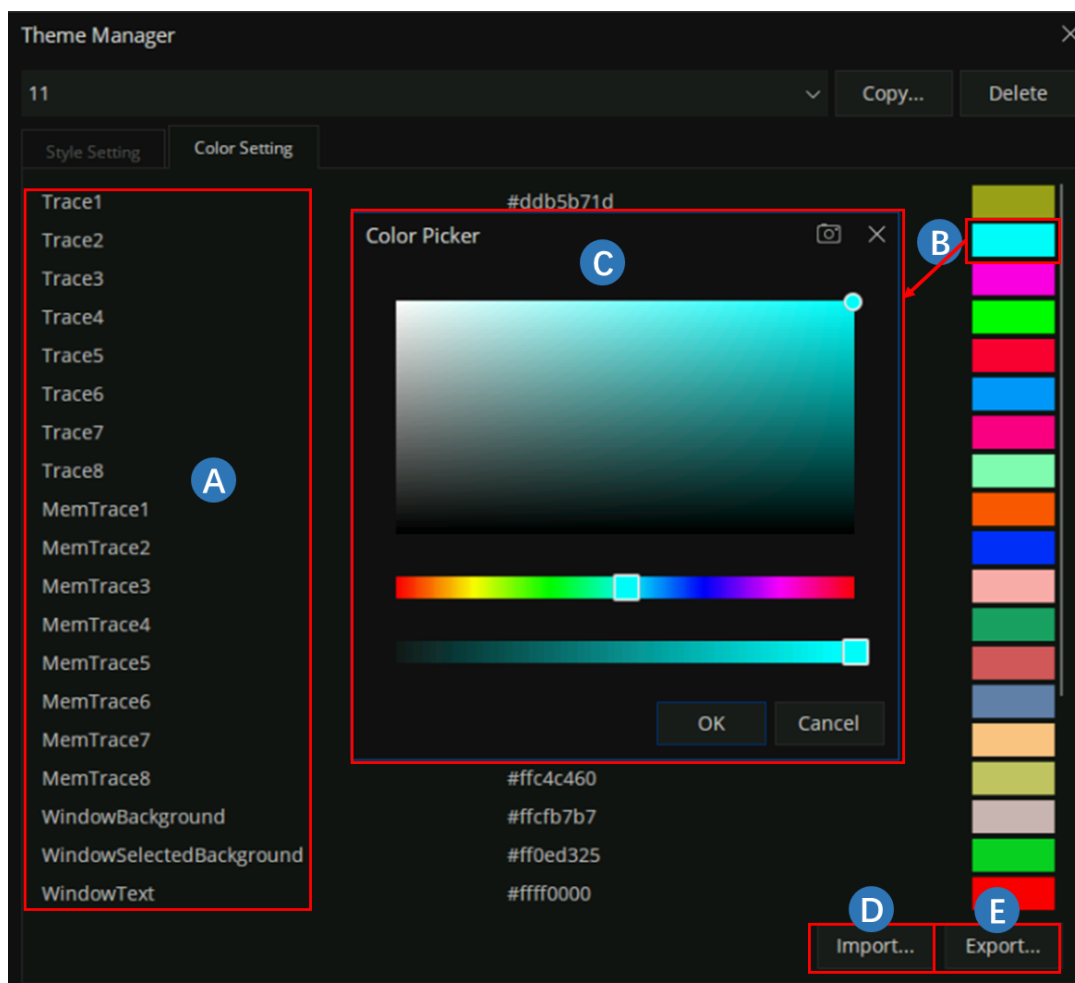

- A. Objects with modifiable colors
- B. Color Box, click to pop up the "Color Picker" interface
- C. "Color Picker" interface
- D. Import Color Settings
- E. Export Color Settings

5.7 Touch Screen

The vector network analyzer is equipped with a 12.1-inch high-resolution color touch LCD screen for trace, function keys, and other measurement-related information. With the help of the touch screen, the LCD screen can be directly touched by a finger to select measurement and parameter setting operations.

- When the **Touch** button display light is on, the touch screen function is on.
- When the **Touch** button display light is off, the touch screen function is off.
- Sliding the screen up and down to display the coordinates of the vertical axis can continuously change the parameters of the vertical axis.

5.8 Help Information

The Help system of the vector network analyzer can provide the Help information of the function keys and menu options on the front panel. Press the Help button on the front panel to enter the **Utility** menu, click **Help** to open the **Help** document, click into the corresponding directory to view the information.

6 Set Up a Measurement

This chapter introduces in detail each function button on the front panel of SNA6000A series vector network analyzers and the following menu functions.

6.1 Measurement Classes

Measurement Classes are categories of measurements that can coexist on a channel. Measurements in a measurement class can not coexist in a channel with a measurement of a different measurement class. For example, a Spectrum Analyzer measurement can NOT reside in a channel that is currently hosting Scalar Mixer Measurements. And Measurement classes vary according to the Vector Network Analyzers model and options installed.

Press the **Meas** > **"S-Params"** > **"Mode..."** to enter the Measurement class dialog, and the box shows the supported classes for Vector Network Analyzers unit. except the "Standard (VNA)" class, all other measurement classes are commonly called "Applications measurement class". Measurement class dialog box shows the supported classes for Vector Network Analyzers unit. The supported classes depends on the product and installed options. As figure below.

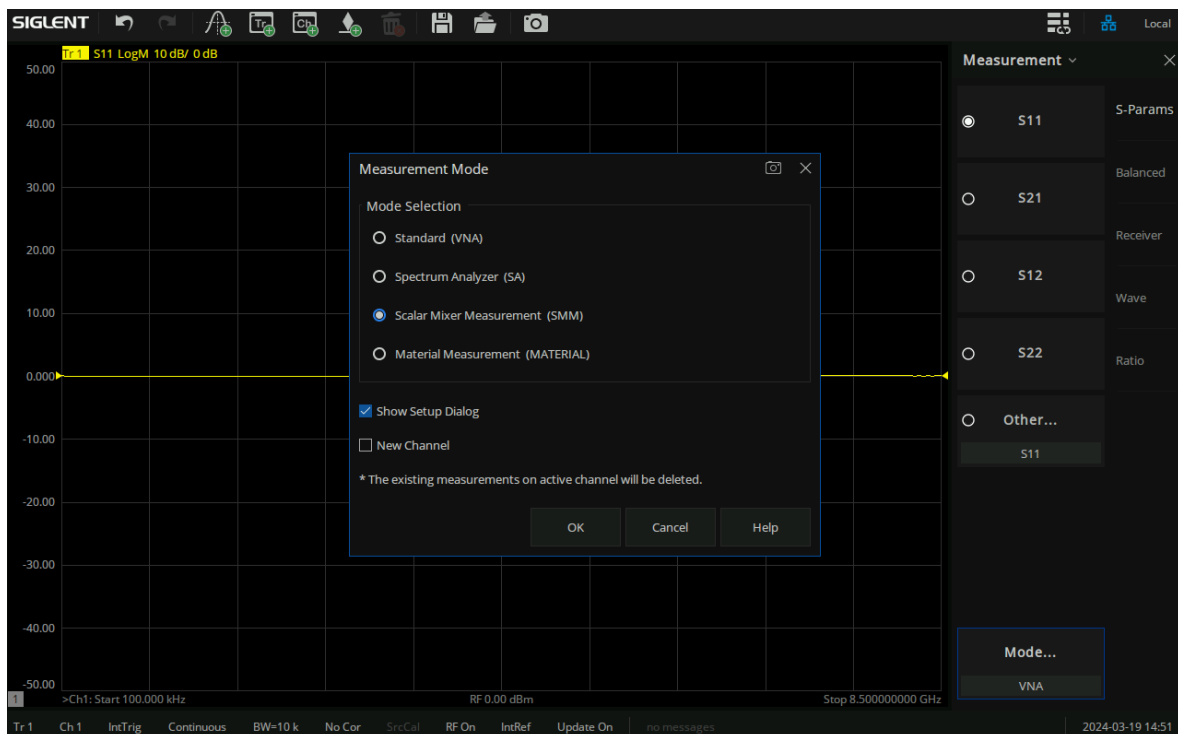

Measurement class select dialog

“**Show Setup Dialog**” check box is selected by default. Indicates that when a measurement class is selected to enable, the measurement configuration dialog box for the measurement class is displayed, so that users can directly set related parameters. If the check box is deselected, the measurement class’s setup dialog box will not be displayed when the measurement class is selected.

“**New Channel**” check box is selected Indicates that create the measurement class in a new channel and new window. A default measurement for that class is created in the channel.

6.2 Measurement parameters

6.2.1 S parameters

S parameters are used to describe the degree of a transmitted or reflected signal through an impedance discontinuity. S parameters are relative measurements, defined as the ratio of two complex voltages. They contain the amplitude and phase information of the relevant signals. For the 2-port vector network analyzer, there are 4 S parameters (S11, S21, S12, S22).

The specific meaning of each S parameter can be described by the following items:

S_{xy} $x,y \in (1,2)$:

- x: The response port is also known as the receiving port of the vector network analyzer. The transmitted signal enters the port after passing through the DUT.
- y: The excitation port is also known as the transmitting port of the vector network analyzer. The output signal of this port is provided to the DUT.

Here is a list of common Measurements with S-Parameters:

Reflection Measurements

- Return loss
- SWR
- Reflection coefficient
- Input impedance
- S11, S22

Transmission Measurements

- Insertion loss
- Transmission coefficient
- Gain/ loss insertion
- group delay
- Linear phase shift
- electrical delay
- S21, S12

6.2.2 Balanced Measurement

6.2.2.1 Balanced Devices

Standard Single-ended devices generally have one input port and one output port. Signals on the input and output ports are referenced to ground. As Fig2.1 Balanced devices have two pins on either the input, the output, or both. The signal of interest is the difference and average of the two input or output lines, not referenced to ground, as Fig2.2.



Fig 2-1 Single-ended devices

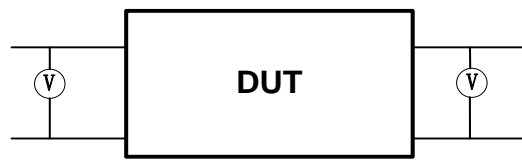

Fig 2-2 Balanced devices

Differential and Common Modes Model

On balanced devices, the signal of interest is the **difference** and **average** of the two input or output lines. In balanced device terminology, these signals are known as the Differential and Common modes.

- Signal A is fixed at 1V peak
- Signal B is selectable
- Differential is calculated as A minus B
- Common is calculated as the average of A and B

Input Signal A and B, A =1V, B=2V

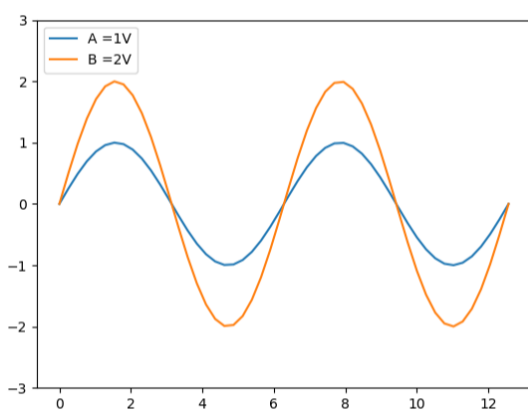

Differential=(A-B), Common=(A+B)/2

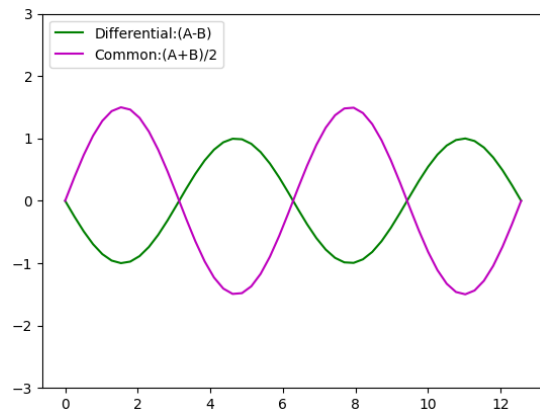

Input Signal A and B, A =1V, B= reverse phase 2V

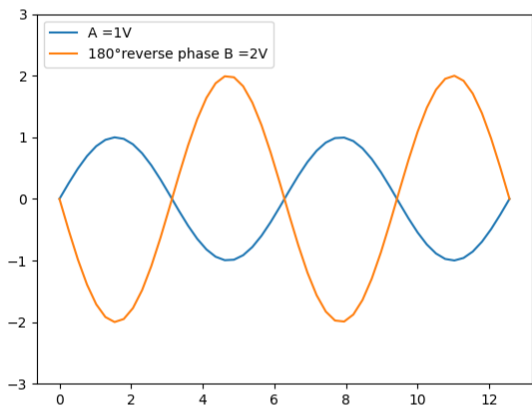

Differential=(A-B), Common=(A+B)/2

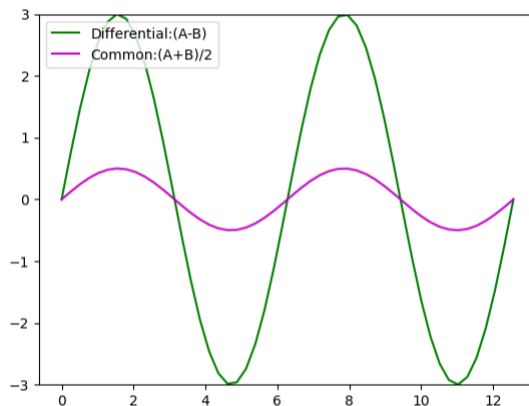

6.2.2.2 Measuring Mixed Mode (Balanced) S-Parameters

The mixed mode S parameter is an extension of the conventional S parameter for balance measurement. If the measuring device is a balanced device, its mixed mode parameters can be measured by the VNA. Some balanced devices are designed to amplify the differential component and reject the common component. This allows noise that is common to both inputs to be virtually eliminated from the output. For example, a balanced device may amplify the differential signal by a factor of 5, and attenuate the common signal by a factor of 5. Using traditional S-parameter notation, an S21 is a ratio measurement of the device **Output**/ device **Input**. Mixing this with balanced terminology, we could view the amplifier's Differential Output signal/ Differential Input signal. To see this parameter on the analyzer, we would select an Sdd21 measurement using the following balanced notation:

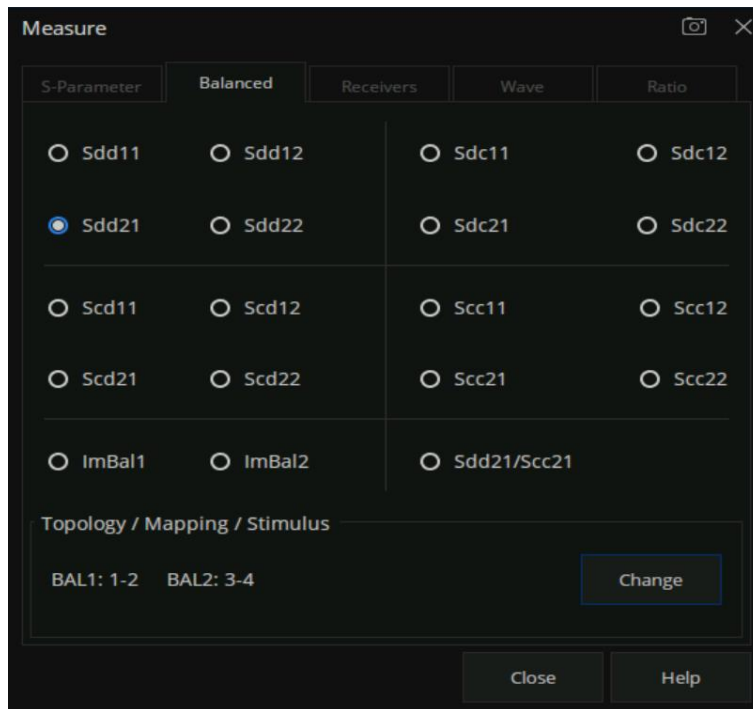

The general notation for the mixed S parameter is Sabxy, where:

- 1) a - Represents the output mode of the device
- 2) b - Represents the input mode of the device

Choose from the following for both a and b

- s – single ended (unbalanced port)
 - d – differential (balanced port)
 - c – common (balanced port)
- 3) x – device output “logical” port number
 - 4) y - device input “logical” port number

6.2.2.3 Measuring Imbalance Parameters

Imbalance is a measure of how well two physical ports that make up a balanced port are matched. With a perfectly balanced port, the same amount of energy flows to both ports and the magnitude of the ratio of these ports is 1. The notation is similar to traditional S-parameters. In the following diagrams, the letters a, b, c, and d are used because any analyzer port can be assigned to any logical port using the port mapping process.

For example, in the following single-ended - balanced formula, Sba indicates the device output port is

logical port b and the input port is logical port a.

(1) Imbalance parameter when measuring a single -balanced device.

$$\text{ImBal} = - \frac{S_{ba}}{S_{ca}}$$

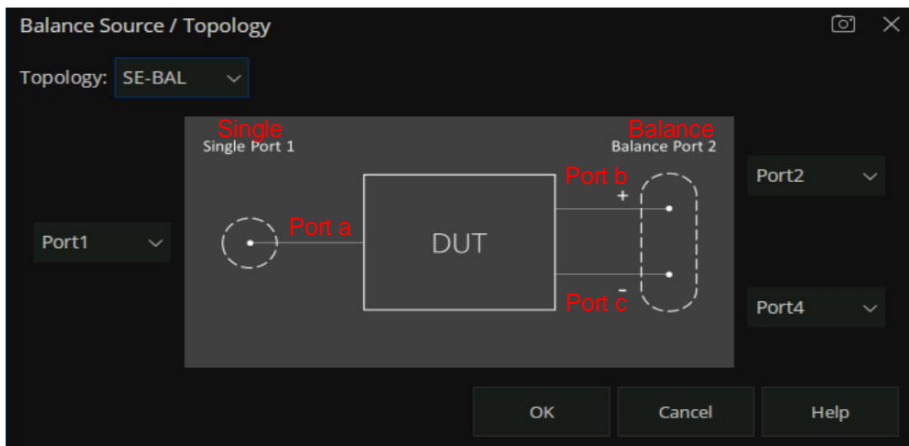

(2) Imbalance parameter of ImBal1 and ImBal2 when measuring a balanced -balanced device.

$$\text{ImBal1} = - \frac{S_{ac} - S_{ad}}{S_{bc} - S_{bd}}$$

$$\text{ImBal2} = - \frac{S_{ca} - S_{cb}}{S_{da} - S_{db}}$$

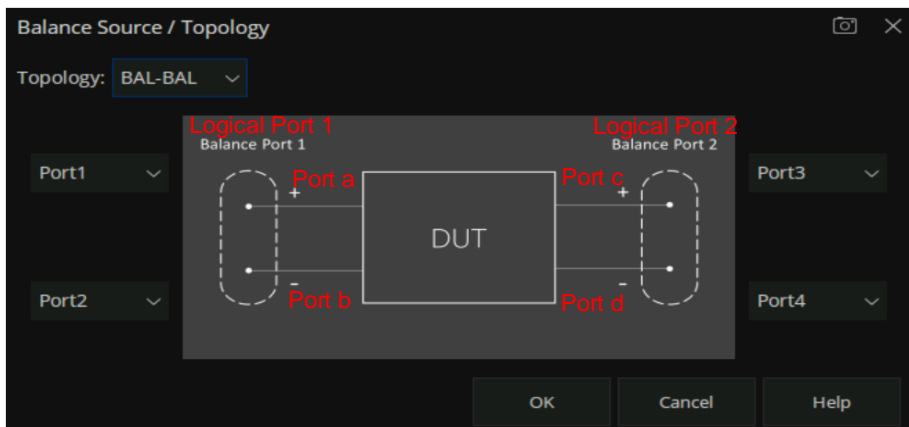

(3) Imbalance parameter of ImBal1 to ImBal4 when measuring a single- single -balanced device.

$$\text{ImBal1} = -\frac{S_{ac} - S_{ad}}{S_{bc} - S_{bd}}$$

$$\text{ImBal2} = -\frac{S_{ca} - S_{cb}}{S_{da} - S_{db}}$$

$$\text{ImBal3} = -\frac{S_{ca}}{S_{da}}$$

$$\text{ImBal4} = -\frac{S_{cb}}{S_{db}}$$

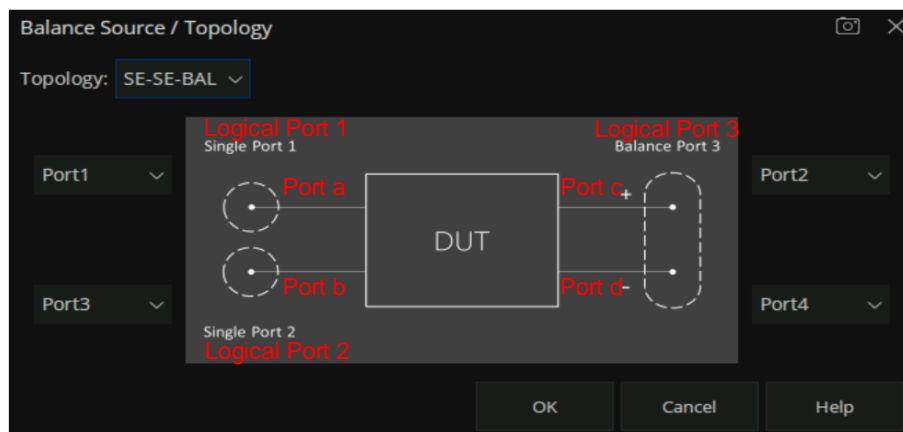

6.2.2.4 Measuring CMRR

CMRR is a ratio of the transmission characteristic in differential mode over the transmission characteristic in the common mode of the balanced port as the measurement parameter. A high value indicates more rejection of common mode, which is desirable in a device that transmits information in the differential portion of the signal. On the measurement balanced parameter TAB interface, click “Change” to set the DUT topology and port mapping relationship. Different DUT topologies lead to different CMRR parameters.

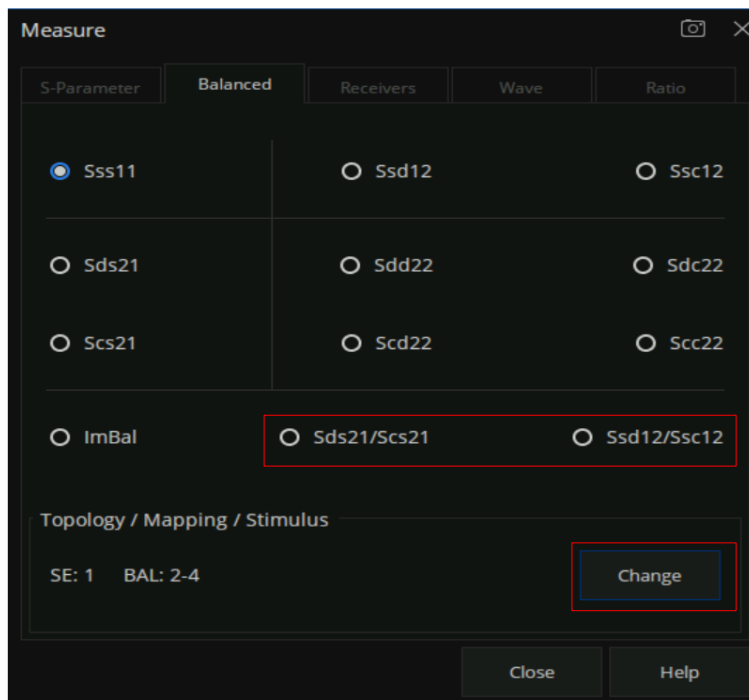

The table below shows the CMRR parameters available when measuring different balanced device.

Balanced device.	CMRR parameters
Single- balanced device	S_{ds21}/S_{cs21} , S_{sd12}/S_{sc12}
Balanced - balanced device	S_{dd21}/S_{cc21}
Single- single- balanced device	S_{ds31}/S_{cs31} , S_{ds32}/S_{cs32}

6.2.2.5 DUT Topology Port Mapping

In the balanced measurement, the signal of interest is the difference or average of two BALANCED input or BALANCED output lines. It is also possible to have single-ended ports AND balanced ports on the same device.

Press the “Meas” button on the front panel → Balanced → Topology... , Create or edit DUT Topology and Logical Port Mapping. The port Topology / Logical port Mapping setting dialog box is as below:

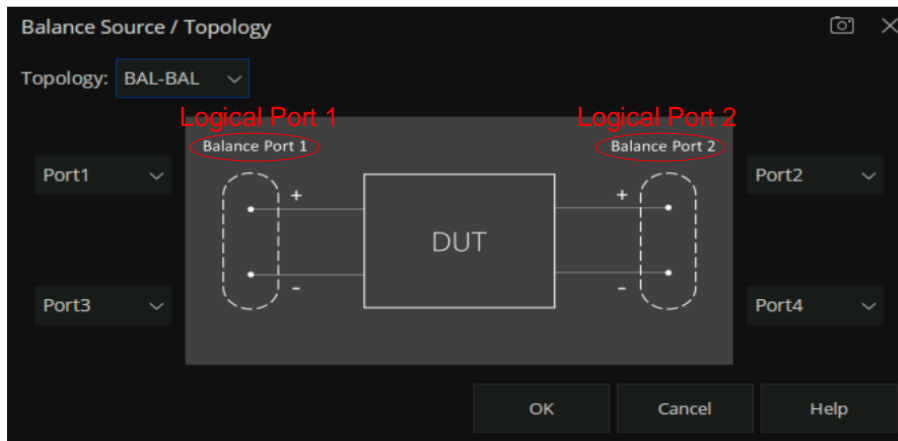

“Logical Port” is used to describe a physical analyzer test port that has been remapped to a new port number.

1. Map any two physical ports of the vector network analyzer to a balanced logical port.
2. Map any physical port of the vector network Analyzer to a single-ended logical port.

These selections apply to ALL measurements in the channel. If the device topology is changed, any existing measurements in the channel that are incompatible with the new topology will be automatically changed to one that is compatible.

The following are the topological relationships of several common differential devices. A multi-port vector network analyzer can be used to measure the following topological relationships for differential devices. When the vector network analyzer has only 2 test ports, then only the first balanced device under test can be tested. When the vector network analyzer has four test ports, then all the devices under test with the following four topological relationships can be tested.

1) **Balanced**

1 Logical port (Balance Port 1) - 2 physical ports (Port1, Port2)

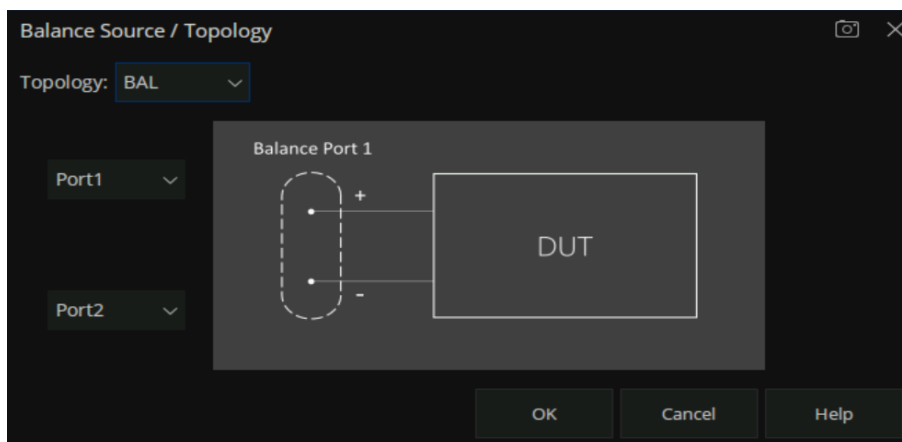

2) Balanced-Balanced

2 Logical port (Balance Port 1, Balance Port 2) - 4 physical ports (Port1, Port2, Port3, Port4)

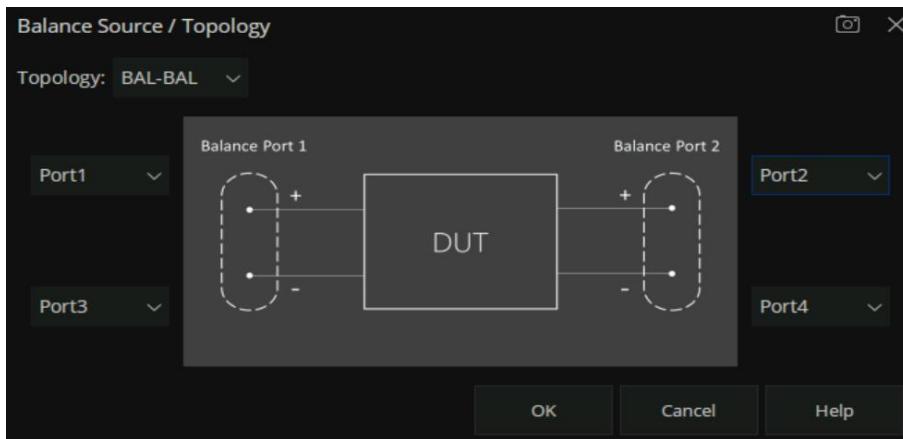

3) Single - Balanced

2 Logical port (Balance Port 1, Balance Port 2) - 3 physical ports (Port1, Port2, Port4)

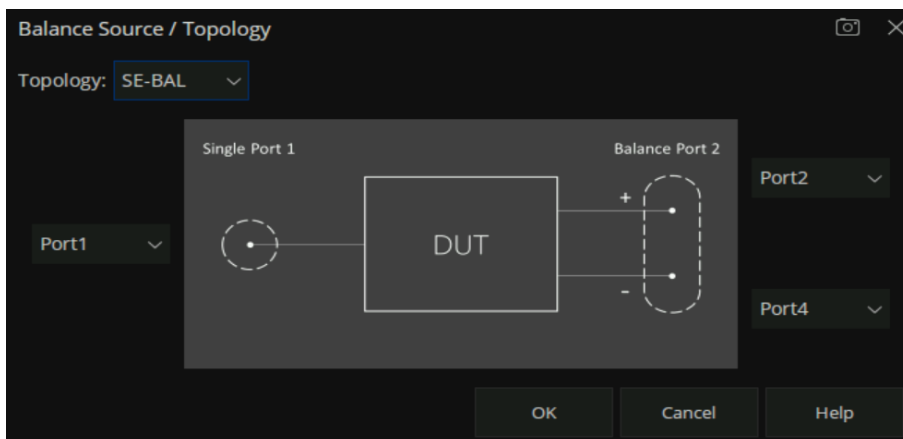

4) Single-Single-Balanced

3 Logical port (Balance Port 1, Balance Port 2) - 4 physical ports (Port1, Port2, Port4)

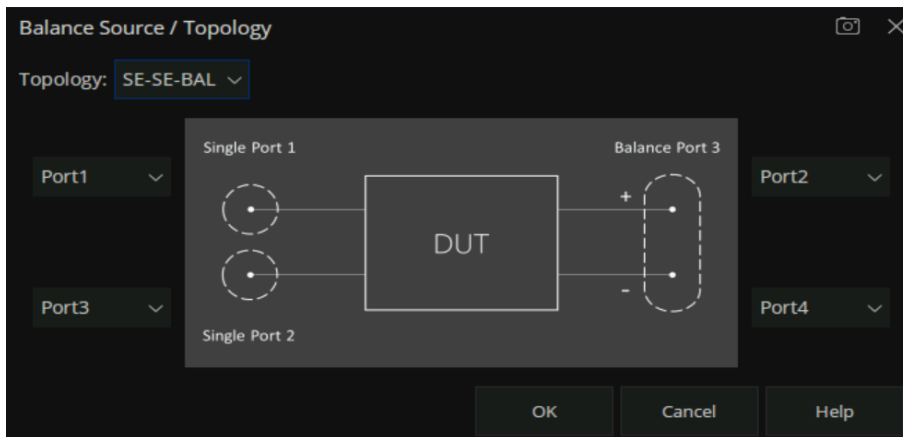

6.2.3 Receiver Measurement

Each port of the vector network analyzer contains 1 reference receiver and 1 measurement reference receiver. For the 4-port vector network analyzer, there are a total of 4 reference receivers and 4 measurement reference receivers. The power measured by these receivers can be compared to obtain all the S parameter indices.

R1, R2, R3, and R4 are the reference receivers used to measure the signal emitted from the vector network analyzer. It is equal to the transmitted power at the port after power calibration.

- R1: Measures the output power of port 1.
- R2: Measures the output power of port 2.
- R3: Measures the output power of port 3.
- R4: Measures the output power of port 4.

A, B, C, and D are test receivers used to measure the reflected or transmitted signal power after passing through the device under test.

- A: Measures the signal power entering port 1.
- B: Measures the signal power entering port 2.
- C: Measures the signal power entering port 3.
- D: Measures the signal power entering port 4.

6.2.4 Wave (Receivers notation)

Receivers can be also selected using logical receiver notation

Press the “Meas” button on the front panel → Wave → Other... to enter the Wave TAB interface.

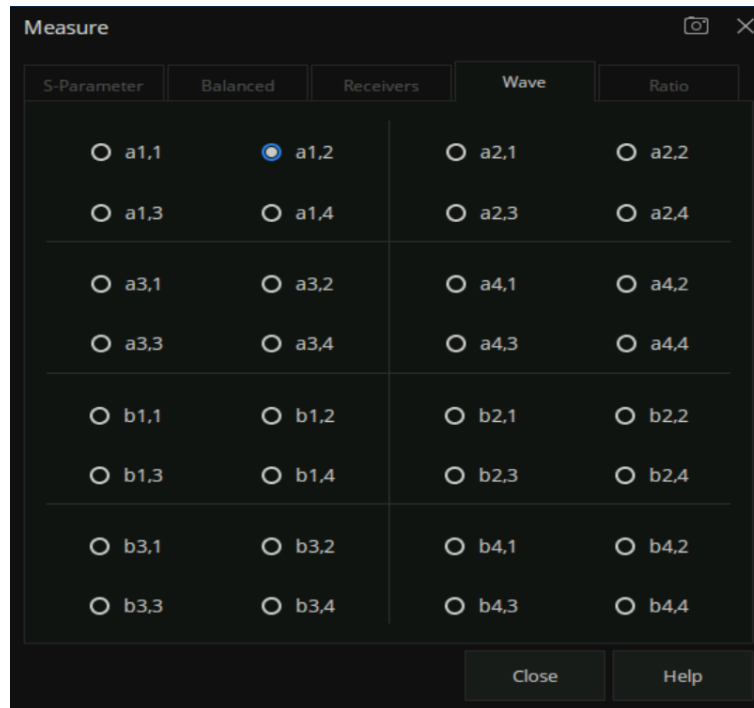

Logical receivers are generally represented by aN, M and bN, M forms.

- aN - Represents Reference receiver for logical port N
- bN - Represents the test port receiver for logical port N
- M – Represents the Physical port number of the output power

For example:

- **a1,1** Represents Physical port 1 outputs power when the reference receiver of logical port 1 is measured. When logical port 1 is mapped to physical port 1, it is equivalent to R1,1;
- **a2,1** Represents Physical port 1 outputs power when the reference receiver of logical port 2 is measured. When logical port 2 is mapped to physical port 2, it is equivalent to R1,2;
- **b1,1** Represents Physical port 1 outputs power when the test port receiver of logical port 1 is measured. When logical port 1 is mapped to physical port 1, it is equivalent to A,1;
- **b2,3** Represents Physical port 3 outputs power when the test port receiver of logical port 2 is measured. When logical port 2 is mapped to physical port 2, it is equivalent to B,3;

6.2.5 Ratio

Ratio measurement allow you to choose your own ratio of any two receivers that are available in your analyzer. S-parameters are actually predefined ratio measurement. For example S11 is A/R1.

Ratio - Check **Activate** to create or change a measurement. Select a receiver for the Numerator, select another receiver for the Denominator, then select a source port for the measurement.

The **Source port** is always interpreted as a logical port number.

For ratio measurement: "b2/a1,1" means that the logical source port number is 1, and the logical port 2 measurement receiver/logical port 1 reference receiver.

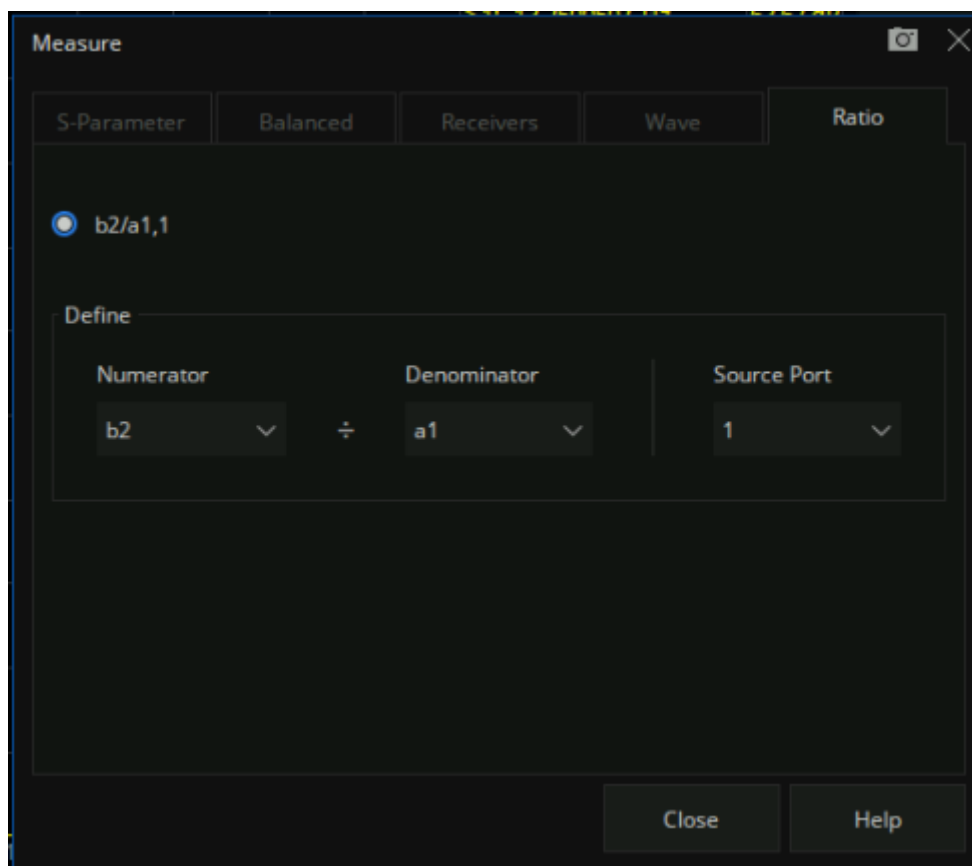

6.3 Frequency range

Frequency range is the span of frequencies you specify for making a device measurement.

6.3.1 Set the frequency range

Set the range of RF frequencies.

Operating steps:

Press **Freq** on the front panel to open the frequency setting interface, parameter change mode:

1. Use the numeric keypad to input the value of the frequency and press the unit button to select the desired unit. The optional units are GHz, MHz, KHz, and Hz. Press Enter to select the current unit by default.
2. Press **ENTER** or the multifunction knob to enter the state of parameter editing. Move the cursor to the specified position by the left and right arrow keys. Modify the value by pressing the up and down key, rotating the knob, or pressing the numeric keypad. Press **ENTER**, the knob, or **ESC** to exit the editing mode.

Note:

- Start: Specify the starting frequency of the swept measurement range
- Stop: Specify the end frequency of the swept measurement range
- Center: Specify a center frequency of the swept measurement range
- Span: Specify the swept measurement frequency range
- Step: Specifies the frequency step size between data points
- Points: Specify the number of measurement points per sweep

6.3.2 CW time sweep or power sweep

Measurements using a CW time sweep or power sweep will be performed on a single frequency rather than the entire frequency range

Operating steps:

Press **Sweep**, use the knob or arrow keys to focus on the **Sweep** → **Sweep type**. Parameter change mode:

1. Press **ENTER** or the knob to enter the parameter editing state and then move the cursor to the specified position by up and down arrow keys or the knob to set the **Sweep type** to **CW Time** or **Power Sweep**. Press **ENTER** or the knob to select the current option.
2. Press **Freq** use the knob or arrow keys to focus on the **Freq** → **CW** parameter entry. Select the edit box to enter the edit mode and change the value by pressing the up and down key, rotating the knob, or pressing the numeric keypad. Press **ENTER**, the knob, or **ESC** to exit editing mode.

6.3.3 Frequency resolution

Set the frequency resolution to 1Hz.

6.4 Power level

Power level refers to the output power at the port of the vector network analyzer.

Here are the keys to operation:

1. Press **Power** , use the knob or arrow keys to focus on the **Power** → **Power Level** parameter item. Input the required power level. Press **ENTER** to exit editing mode. The default unit is dBm.
2. Press **Power** , use the knob or arrow keys to focus on the **Power** → **RF Power** parameter item. Turn on or off RF power.
3. Press **Power** , use the knob or arrow keys to focus on the **Port Power** parameter item, Configure start and stop power. Start and stop power are only available in power sweep mode.
4. Press **Power** , use the knob or arrow keys to focus on the **Port Power** → **Select** parameter item, Press **ENTER** or the knob to select the corresponding power port.
5. Press **Power** , use the knob or arrow keys to focus on the **Port Power** → **Coupling** parameter item, Press **ENTER** or the knob to choose to turn coupling off or on.
6. Press **Power** , use the knob or arrow keys to focus on the **Leveling & Offsets** → **Slope Enable** parameter item, Press **ENTER** or the Knob to turn on the Slope switch, Press **Leveling & Offsets** → **Slope** to set the Slope.

6.4.1 Coupled port power

- Coupling (selected): The power level of each test port is the same. If the power of any test port is set, the power of all test ports will change accordingly.
- Decoupling (clearing): Set the power level for each test port separately and decouple the Power. For example, if you want to measure the gain and reverse isolation of a high gain amplifier, the input port of the amplifier requires much less power than the output port. Power sweep can also be performed using uncoupled power

6.4.2 Power Leveling and Offsets overview

Power Limits controls the source power at each test port for ALL channels. Use this feature to protect DUTs that are sensitive to overpowering at the input. Source Power levels that exceed the Limit at the specified port are clipped at the limit, and an error message is displayed on the screen.

Power Offset provides a method of compensating port power for added attenuation or amplification in the source path. The result is that power at the specified port, all dialogs, and annotations reflect the added components. For amplification use a positive offset, and for attenuation use a negative offset.

Using the Softkey for setting: Press the “Power” key, “Power” > Leveling & Offsets then enter the menu.

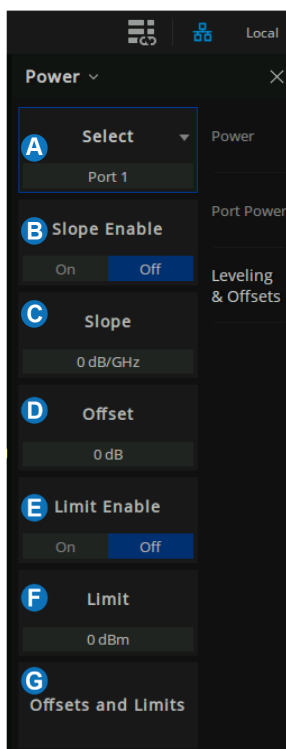

- A. Select the Port.
- B. Slope Enable. Helps compensate for cable and test fixture power losses at increased frequency. With power slope enabled, the port output power increases (positive input) or decreases (negative input) with the sweep frequency.
- C. Set the slope value
- D. Set the power offset value
- E. Power Limit Enable
- F. Set the power limit value
- G. Power Offsets and limits

6.4.3 Power Offsets and Limits setting

Using the Softkey for setting: Press the “Power” key, “Power” > Leveling & Offsets > Offsets and Limits to enter the menu. You can change the cell value in one of the following two ways:

1. On the UI interface, click the cell twice in succession and then enter the value in the pop-up virtual numeric keyboard.
2. Press the Tab key on the front panel to make the focus fall on the cell you want to change, press

the number key +Enter on the front panel to set the value, or turn the knob to change the value.

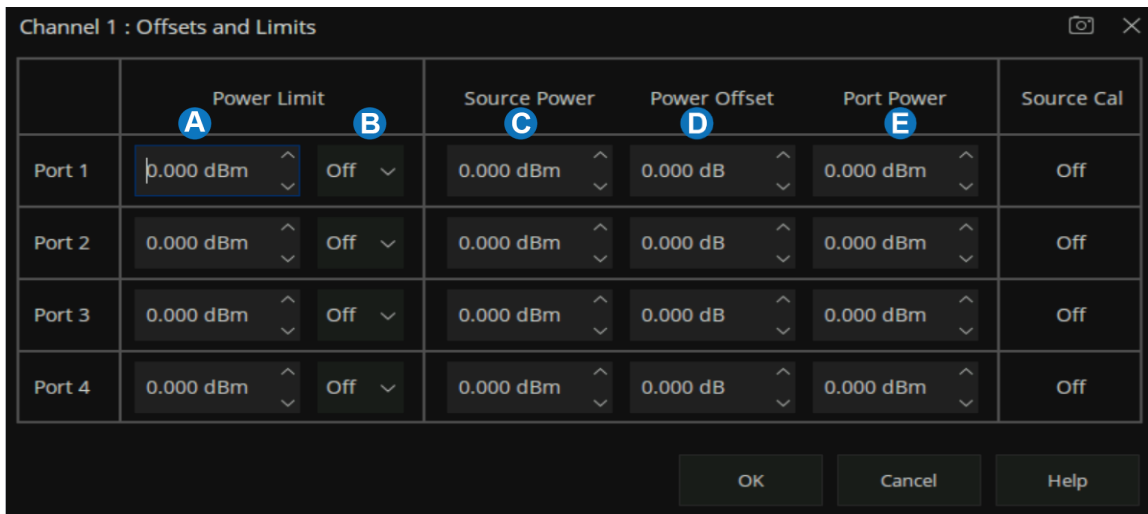

- A Global Power Limit. This sets a maximum source power level for individual test ports. This value limits port power for all channels and all applications. Power levels that attempt to exceed the power limit are clipped at the limit.
- B Power Limit Enable. Selects On indicate that power is limited to the adjacent value at the specified source port and selects Off indicate that power is not limited to this value, but the maximum power of the source.
- C Set the Source Power value.
- D Set the Power Offset value.
- E Set the Port Power value. The formula among Source Power, Power Offset, and Port Power is: $\text{Source Power} + \text{Power Offset} = \text{Port Power}$

6.5 Sweep

Sweeping refers to the measurement of a series of consecutive data points against a series of specified excitation values.

6.5.1 Points

Data points are the number of data samples representing the measured values at a single excitation

value. You can specify the number of data points that the vector network analyzer measures in a sweep. The sweeping time of the vector network analyzer varies proportionally with the number of points.

Operating steps:

Press **Sweep**, use the knob or arrow keys to focus on the **Sweep** → **Number of Points** parameter item, Enter the number of points required, Press **ENTER** to exit editing mode.

The number of data points collected by the vector network analyzer during the measurement sweep can be set to any number between 1 and 100001.

Note: Maximum point limits may differ for some measurement classes.

- For maximum trace resolution, use the maximum data points.
- For faster throughput, use a minimum number of data points to provide an acceptable resolution.
- To get the best number of points, look for values that do not differ significantly in the measurement as you add points.
- To ensure accurate measurement calibration, ensure that the user uses the same number of points for calibration and measurement.
- Points are the number of data items collected in one sweep. This number can be set separately for each channel.
- To obtain high trace resolution for excitation values, select a larger point value.
- For high throughput, keep the smaller point value within the allowable trace resolution range.
- For high measurement accuracy after calibration, use the same number of points as the actual measurement.

6.5.2 Sweep type

Key operation:

Press **Sweep**, use the knob or arrow keys to focus on the **Sweep** → **Sweep Type** parameter item. Press **ENTER** or Knob to enter the editing state, then move the cursor to the specified position by up and down direction keys or Knob, set the sweep type to the required measurement type, press **ENTER** or Knob to select the current option.

Sweep type:

- Linear Frequency
- Log Frequency

- Power Sweep
- CW Time
- Segment Sweep

Linear Frequency: Set the measured abscissa frequency scale as a linear scale, and keep the full frequency scale at equal intervals.

Log Frequency: Set the measured abscissa frequency scale to log scale, to observe a wider frequency range, the calibration interval in the full frequency band is not uniform and presents periodic changes.

Power Sweep: The power sweep will increase or decrease the power of the source according to the walk length. Power sweeping is used to characterize power-sensitive circuits through measurements such as gain compression. In the Sweep Type dialog box, you can specify “Start Power”, “Stop Power”, “CW Frequency”, “Points”.

Segment Sweep: “Segment Sweep” activates a sweep consisting of frequency sub sweep (called segmentation). For each segment, you can define a separate power level, IF bandwidth, IF bandwidth for each port, sweep time, delay, sweep mode. After the measurement calibration has been performed on the entire sweep or all segments, the measurement values of one or more segments can be calibrated.

In the Segment Sweep type, the vector network analyzer performs the following operations.

- Sort all defined segments in order of increasing frequency.
- Measurements were made at each point.
- Display a trace containing all retrieved data.

Limitations on segmented sweeping:

- The frequency range of one segment may not overlap with the frequency range of any other segment.
- The number of segments is limited only by the combined data points of all segments in the sweep.
- The frequency range of one segment may not overlap with the frequency range of any other

segment.

- The number of segments is limited only by the combined data points of all segments in the sweep.

Operating steps:

Press **Sweep**, Use the knob or arrow keys to focus on the **Sweep** → **Sweep Type** parameter item.

Parameter change mode:

1. Press **ENTER** or Knob to enter the state of parameter editing, then move the cursor to the specified position by up and down arrow keys or Knob, set the sweep type as **Segment Sweep**, and press **ENTER** or Knob to select the current option.
2. Press **Sweep**, use the knob or arrow keys to focus on the **Segment Table** parameter item. Move the cursor to the specified position by up and down arrow keys or knobs, set Add Segment, Insert Segment, Delete Segment and Delete All Segments to perform segment operation. Select the segment table for segment setting and tick the corresponding menu to display the corresponding contents in the following segment.

+	State	Start	Stop	Points	Power Level	Sweep Time	Delay	IF Bandwidth
1	On	9.000 kHz	1.000000000 GHz	201	0 dBm	182.30700 ms	0.00000 s	1.000 kHz
> 2	Off	1.000000000 GHz	4.500000000 GHz	801	5 dBm	71.08475 s	0.00000 s	10 Hz

Figure 6-1 Segment table

X-Axis Point Spacing: In segment sweep mode, this feature will affect how the segment trace is drawn on the screen. This function is in the sub-sweep table menu.

- When X-axis point spacing is not used, multi-segment sweeping traces may sometimes result in many measurement points being squeezed into a narrower portion of the X-axis
- When X-axis point spacing is used, the X-axis position of each point needs to be selected so that all measurement points are evenly distributed along the X-axis.

For example, suppose you have the following two sections:

	+	State	Start	Stop	Points
>	1	On	870.000000 MHz	970.000000 MHz	201
	2	On	970.000000 MHz	1.070000000 GHz	801

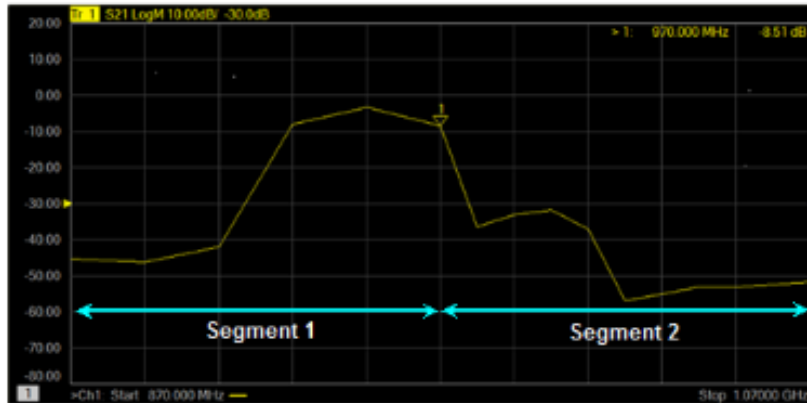

Figure 6-2 X-point spacing is not used

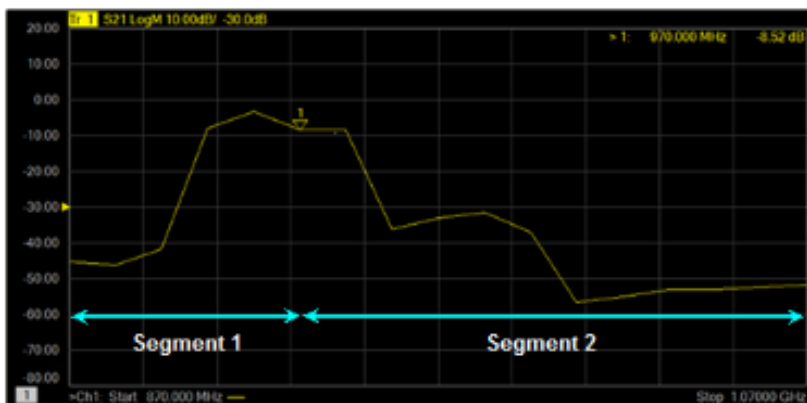

Figure 6-3 Use X-axis point spacing

6.6 Trigger

The trigger is the signal that causes the vector network analyzer to carry out the measurement sweep. The vector network analyzer is flexible in the configuration of the trigger function.

6.6.1 Trigger Settings

Operating steps:

Press **Trigger**, use the knob or arrow keys to focus on the **Trigger** parameter item.

6.6.2 Trigger source

Operating steps:

Press **Trigger**, Use the knob or arrow keys to focus on the **Trigger Source** parameter item. Press **ENTER** or the Knob to enter the parameter editing state, then move the cursor to the specified position by the up and down arrow keys or the knob, and press **ENTER** or the knob to select the current option.

Trigger source: These Settings determine the source of the trigger signal for all existing channels. A valid trigger is generated only if the vector network analyzer is not sweeping.

- Internal triggers: After the previous measurement is completed, the vector network analyzer will immediately send a continuous trigger signal.
- Bus trigger: The vector network analyzer waits for the SCPI trigger instructions issued by an external controller (PC).
- External trigger: Trigger signals generated by external devices received through the BNC Connector on the rear panel.
- Manual trigger: Manually send a trigger signal to the vector network analyzer. Available Only when you select "Manual" to trigger.

6.6.3 Trigger Range

Operating steps:

Press **Trigger**, Use the knob or arrow keys to focus on the **Trigger Scope** parameter item. Press **ENTER** or the Knob to enter the parameter editing state, then move the cursor to the specified position by the up and down arrow keys or the knob, and press **ENTER** or the knob to select the current option.

- All channels: Triggers are sent to all triggerable channels. A trigger will sweep all channels that can be triggered. (Default setting)
- Current channel: Triggers are sent to the current channel but after the current channel completes, the channel increments to the next triggerable channel.

6.6.4 Channel Settings

Operating steps:

Press **Trigger**, use the knob or arrow keys to focus on the **Trigger** parameter item. Press **ENTER** or the Knob to enter the parameter editing state, then move the cursor to the specified position by the up and down arrow keys or the knob, and press **ENTER** or the knob to select the current option.

These settings determine the number of trigger signals that the channel will receive.

- Hold trigger: The channel does not accept any trigger signals.
- Single trigger: The channel receives a trigger signal and then enters the “hold” state. Another way to trigger a single measurement: Set the trigger source to “manual” and send a manual trigger. At this point, however, all channels are set to single trigger.
- Continuous trigger: Channels accept an unlimited number of trigger signals.
- Hold all channels: All channels enter the hold state and do not accept any trigger signals.
- Restart: (Accessible only from the Trigger menu.) Channels that are in the Hold state are set to be triggered once (The channel accepts a single trigger signal). All other Settings are unaffected.
- A single trigger: The channel receives a trigger signal and then enters the “hold” state. Another way to trigger a single measurement is to set the trigger source to “manual” and send a manual trigger. At this point, however, all channels are single.
- Restart: Stops the currently sweeping Channel, and re-sweep when a new trigger signal is received.

Examples:

1. When the trigger source is internal trigger and the trigger mode is "Single" or "Continuous", click the "Restart" then the trace will re-sweep from the first frequency point.
2. When the trigger source is Manual/External/Bus and the trigger mode is "Single" or "Continuous", click the "Restart" will stops the currently sweeping and re-sweep when a new trigger signal is received.
3. When channel in Hold mode, click the "Restart" does not do anything.
4. Multiple Channels in Continuous mode: The current sweep on the current channel is stopped, and the first channel that can sweep is started.

6.6.5 Trigger mode

Operating steps:

Press **Trigger**, use the knob or arrow keys to focus on the **Trigger** → **Trigger Setup** parameter item. Press **ENTER** or the Knob to enter the parameter editing state. Then move the cursor to the specified position by the up and down arrow keys or the knob, and press **ENTER** or the knob to select the current option.

These settings determine the number of trigger signals that the channel will receive.

- Sweep trigger: Each “manual” or “external” trigger causes all traces of the shared source port to be swept in the order specified below. In the case of a “single” trigger, the count decrements by 1 after sweeping all traces in all directions.
- Point trigger: Each “manual” or “external” trigger results in a measurement of a data point. Subsequent triggers go to the same trace until it completes, the other traces in the same channel are then swept in the order specified below. If it is a "single" trigger, the count decreases by 1 after measuring all data points on all trace lines in the channel.

When multi-port calibration is on (requires multi-direction sweeping), the trace on the screen will not be updated until all relevant directions have been swept. For example, when all four 2-port S parameters are displayed:

- a) If full 2-port calibration is on, triggering 1 will cause no trace to be updated.
- b) When the calibration is off, triggering 1 will cause S11 and S21 updates. Trigger 2 will cause updates to S22 and S12.

Trace sweep order:

For all trigger modes, the trigger signal remains in the same channel until all traces in this channel have been swept, and then continue to trigger the next channel that is not in the "hold" state.

The traces within each channel are always swept in the following order:

The trace on the screen will not be updated when the multi-port calibration is turned on (requiring multi-direction sweeping) until all relevant directions have been swept.

For example, when all four 2-port S parameters are displayed:

- a) If full 2-port calibration is on, triggering 1 will cause no trace to be updated; Triggering 2 causes all S parameters to be updated.
- b) When the calibration is off, triggering 1 will cause S11 and S21 to be updated; Triggering 2 will cause S22 and S12 to be updated.

6.6.6 External and auxiliary triggers

Both external and auxiliary triggers are used to synchronize the triggers of the vector network analyzer with those of other devices.

Overview:

Ready signal and trigger signal:

Ready signals are different from trigger signals. The ready signal is used to indicate that the transmitting instrument is ready for measurement. The instrument receiving the ready signal then sends a trigger signal indicating that the measurement will be made or that the measurement has been completed. Usually, the slower instrument sends the trigger signal.

- Measurement trigger input: This signal is easy to use, but has limited configuration capabilities.
- Auxiliary trigger outputs: Connectors and signals are highly configurable and can be used to synchronize with any number of devices.

Measurement trigger input

The trigger input connector is located on the back panel of the vector network analyzer. These signals can be used when the vector network analyzer communicates with slower instruments.

Operating Steps:

- The vector network analyzer sends a “ready” signal when it is ready for measurement
- The external device sends a trigger signal to the vector network analyzer when it is ready for measurement
- Additional signals are provided on the vector network analyzer processor I/O to indicate that the vector network analyzer sweep has been completed and the processor can be set for the next measurement.

To make the vector network analyzer respond to measured trigger inputs or processor I/O signals, select External on the “Trigger Settings” tab on the “Source” Settings. Also, on the Trigger Settings tab, on the Range Settings, select whether an external trigger applies to all channels (global) or one channel (local). The appropriate settings to apply are as follows:

Main trigger input:

Global/ channel trigger delay - after receiving an external trigger, the start time of the sweep will be delayed by the specified amount of time plus any inherent delay.

- When the trigger scope is “channel”, the delay value is applied to the specified channel.
- When the Trigger Range is Global, the same delay value is applied to all channels.

The vector network analyzer receives the trigger input signal through the following connectors:

- Measure trigger input BNC connector: Trigger input on the rear panel.
- Processor I/O Pin 18 (needs to be changed).

Polarity:

High level: When the vector network analyzer is ready (trigger ready) and the TTL signal on the selected input is “high”, it triggers the vector network analyzer.

Low level: When the vector network analyzer is ready (trigger ready) and the TTL signal on the selected input is “low”, it triggers the vector network analyzer.

Positive edge: When the vector network analyzer is ready, it will trigger on the next positive edge. When set to accept a trigger before ready, if a positive edge has been received since the last data acquisition, the vector network analyzer will trigger immediately after ready

Negative edge: When the vector network analyzer is ready, it will trigger on the next negative edge. When set to accept the trigger before ready, if a negative edge has been received since the last data acquisition, the vector network analyzer will trigger immediately after ready.

After receiving the trigger selection before being ready, the vector network analyzer will move to the ready state (trigger ready), if any triggers have been received since the last data fetch, the vector network analyzer will trigger immediately and the vector network analyzer will remember only one trigger signal. All other signals will be ignored.

- If this check box is cleared, any trigger signals received by the vector network analyzer before it is ready will be ignored.
- This feature is only available when a positive or negative edge trigger is selected.

Auxiliary trigger

The auxiliary trigger connector is located on the back panel of the vector network analyzer. When the external source is configured as an external device, the vector network analyzer will automatically control all trigger settings. Do not set other trigger settings. The vector network analyzer will start measuring when it receives a valid trigger signal from the specified trigger source:

- Inside: Measurements begin immediately.

- Manual: Press the vector network analyzer “Trigger” button to start the measurement.
- External: The measurement starts when the measurement trigger input signal is received from the external device. This must be configured separately.

The “Auxiliary Trigger Output” signal can be configured to be sent just before the measurement is performed or just after the measurement is completed. When communicating with an external source, the “Auxiliary Trigger Output” signal should be sent after the measurement is completed to indicate that the external source can be set for the next measurement.

Enable: When checked, the signal can be output to external devices using auxiliary connectors.

- Channel: This setting is controlled by the vector network analyzer “Preferences” setting.
- Global: All secondary trigger settings apply to all channels. On the Trigger Settings tab, set the “Each Point” setting, which also applies to all channels.

Channels: All secondary trigger settings will be applied to the specified channel and each channel can be configured individually.

Auxiliary channel output (to device):

The following settings control the properties of the signal emitted from the “Auxiliary Trigger Output” connector on the back panel:

Polarity:

Positive pulse: the output pulse is positive.

Negative pulse: The output pulse is negative.

Location:

Before acquisition: Send pulses just before data collection begins.

After the acquisition: Pulses are sent immediately after data collection is completed.

Each point: When checked, trigger output can be sent for each data point, and when cleared, trigger output can be sent for each sweep.

Select “Auxiliary Trigger” - “Global” vector network analyzer preferences, on the “Trigger Settings” tab, the “Dot” Settings are set. After that, this setting applies to all channels. When multiple channels

exist, the channel settings set last are used.

Pulse Duration: Specify the duration of a positive or negative output trigger pulse.

6.7 Data format

The data format is the method by which the vector network analyzer displays the measured data graphically. Select the data format that corresponds to the information you want to know about the test device.

6.7.1 Display format

Operating steps:

Press **Format**, Use the knob or arrow keys to focus on the **Format** parameter item. Press **ENTER** or the Knob to enter the parameter editing state, then move the cursor to the specified position by the up and down arrow keys or the knob, and press **ENTER** or the knob to select the current option.

6.7.2 Cartesian coordinates display format

Nine of the twelve available data formats use rectangular displays to present measurement data. This display is also known as Cartesian, XY, or linear coordinates. The Cartesian coordinate display is especially suitable for clearly displaying the frequency response information of the device-under-test (DUT).

- The excitation data (frequency, power, or time) is linearly scaled and displayed on the X-axis
- The measured response data is displayed on the Y-axis

Log amplitude scheme:

- Display amplitude (no phase)
- Y: dB
- Typical measurements: Return loss, insertion loss, or gain

Phase format:

The phase of the signal is measured relative to the calibration reference plane, within a range of ± 180 degrees.

- Display phase (no amplitude)
- Y: Phase (degrees)
- Each 180-degree trace is “wrapped” for easy scaling
- Typical measurement: Linear phase shift.

A phase:

- Same phase, but no 180-degree entanglement.

Note: Phase unwrapping is accomplished by comparing the phases of two adjacent data points. If the phase difference between the two points is greater than 180 degrees, or the DC offset phase of the first data point is greater than 180 degrees, then the phase measurement may not be accurate.

Group delay format:

- Displays the transmission (propagation) time of signal in the device
- Y: Time (s)
- Typical measurement: Group delay

Linear amplitude scheme:

- Only positive values are displayed
- Y: No Unit (U, suitable for proportional measurements)
Watts (W, suitable for disproportionate measurements)
- Typical measurements:
- Reflection and transmission coefficients (amplitude), time domain transformation

SWR format:

- Displays the reflection measurements calculated from the formula $(1 + R) / (1 - R)$, where R is the reflection coefficient

- Valid for reflection measurements only
- Y: No units
- Typical measurements: SWR

Real number format:

- Show only the real part of the measured complex data
- Can display both positive and negative values
- Y: No units
- Typical measurements: Time domain, auxiliary input voltage signals for maintenance purposes

Imaginary number format:

- Only imaginary parts of the measured data are displayed
- Y: No units
- Typical measurement: Network impedance matching

6.7.3 Polar coordinates

The polar coordinate format is used to view the amplitude and phase of the reflection coefficients in S11 or S22 measurements.

You can use a cursor to display the following items:

- Linear or log amplitude (in dB)
- Phase (in degrees)

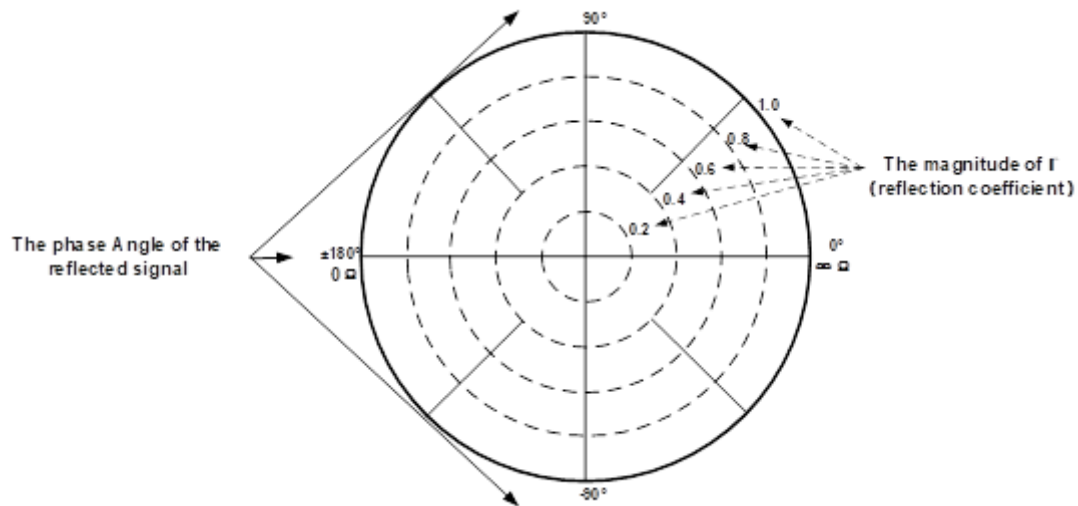

Figure 6-4 Polar diagram

- The dotted circle indicates the reflection coefficient. The outermost circle represents the reflection coefficient with a value of 1. The center of the circle represents the reflection coefficient with a value of 0.
- The radial line shows the phase angle of the reflected signal. The right-most position corresponds to the zero-phase angle (that is, the reflected signal has the same phase as the incident signal). The phase differences of 90° , $\pm 180^\circ$, and -90° correspond to the top, leftmost, and bottom of the polar display, respectively.

6.7.4 Smith circle diagram

Smith diagrams are a tool for mapping complex reflectance coefficients to test the impedance of equipment. In the Smith chart, the linear impedance plane is reshaped to form a cyclic grid from which the resistance and reactance ($R + jX$) can be read.

You can use a cursor to display the following items:

- Resistance (in Ohms)
- Reactance as equivalent capacitance (in Ephraeras) or inductance (in Henrys)

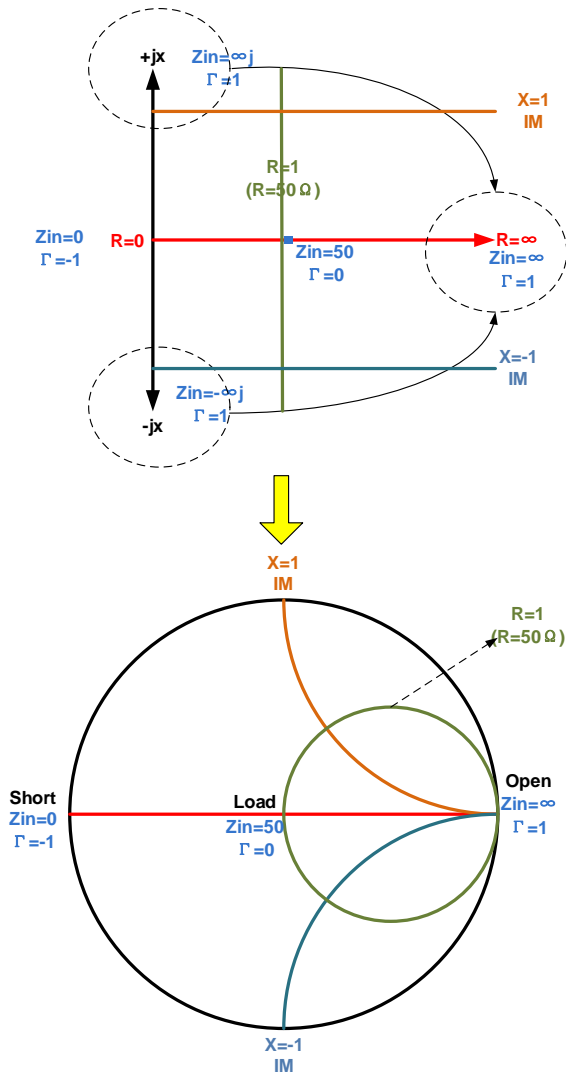

Figure 6-5 Schematic diagram of Smith circle

There is also a Reverse Smith circle diagram (also called an Admittance Smith Chart):

Same as the standard Smith circle, with the following exceptions:

- The polar grid is reversed from right to left.
- Admittance (in Siemens) instead of resistance.

Smith diagram interpretation:

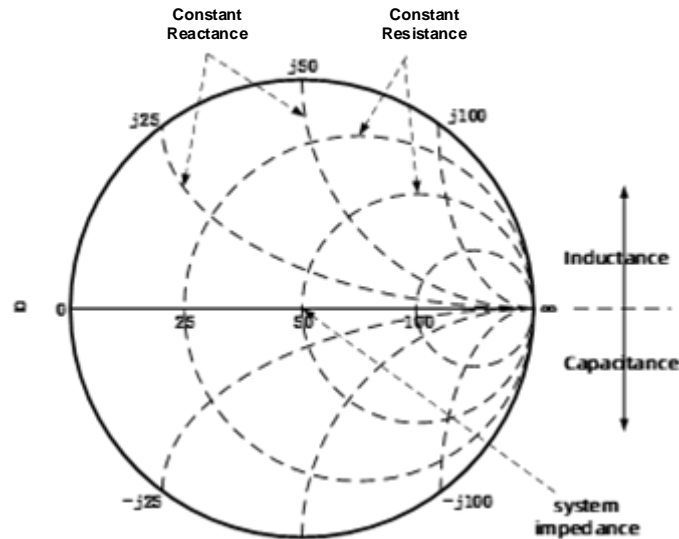

Figure 6-6 Schematic diagram of Smith circle

- Each point on the Smith chart represents a complex impedance ($r \pm jx$) consisting of a real resistance (r) and an imaginary reactance (x).
- The horizontal axis (solid line) shows the real part of the difference between impedance and resistance. The horizontal axis always represents the system impedance. The rightmost value is infinite ohms (open path). The leftmost value is zero ohms (short circuit).
- The dotted circle intersecting the horizontal axis represents a constant resistance.
- A dashed arc tangent to the horizontal axis represents a constant reactance.
- The top half of Smith's circle is the region where the reactance component is positive and hence inductance is generated.
- The lower half is the region where the reactance component is negative and therefore generates capacitance.

6.8 Scale

6.8.1 Scale/reference level and position

The "Scale", "Reference Level", and "Reference Position" Settings (as well as the format) determine how the data trace will appear on the vector network analyzer screen.

Operating steps:

Press **Scale**, Use the knob or arrow keys to focus on the reference level and reference position parameter items under the **Scale** menu bar. Press **ENTER** or the knob to enter the parameter editing state, then move the cursor to the specified position by the up and down arrow keys or the knob, and press **ENTER** or the knob to select the current option.

Scale: Sets the vertical indexing value of the rectangular coordinate display format. In polar coordinates and Smith chart formats, the scale sets the value of the outer perimeter. Range: 0.001 dB/div to 1000 dB/div. Scale do not apply in logarithmic scale type.

Automatic scaling: Automatically sets the vertical indexing value and reference value to fit the working data trace in the screen grid area. The excitation value and reference position are not affected. The vector network analyzer determines the minimum possible scaling factor that will allow all display data to appear on the 80% vertical grid. The selected reference values center the trace on the screen.

All autoscaling: Automatically scales all data traces in the working window to fit vertically into the grid area of the screen.

Reference level: Sets the value of the guide in rectangular format. Range: -1000dB to 1000dB. In polar coordinates and Smith's circle chart formats, and logarithmic scale type, the reference level does not apply.

Reference position: Sets the position of the guide in Rectangular coordinate format. Zero is the bottom line and 10 is the top line. The default position is 5 (middle of the screen). Reference positions do not apply in polar coordinates, Smith chart formats and logarithmic scale type.

6.8.2 Scaling coupling

When "Scale Coupling" is enabled, tracks of the same format will have the same "Scale", "Reference Level", and "Reference Position". You can choose to couple the scales for traces in the same window, for all traces in all Windows, or uncouple them.

Operating steps:

Press **Scale**, use the knob or arrow keys to focus on the **Scale** → **Scale Coupling** parameter item. Press **ENTER** or Knob to enter the editing state, select **Off / Window / All**, then move the cursor to

the specified position by up and down arrow keys or Knob, press **ENTER** or Knob to select the current option

Note: Traces of the same format have the same scale, reference level, and reference position.

Coupling Method:

Close: No coupling. Each trace is scaled individually. This is the default setting.

Window: All traces of the same format in each selected window share the same scale settings

All: Coupled between all selected windows, all traces of the same format in all selected windows share the same scale settings.

- When window or full coupling is enabled, the scale settings for the working trace will be adopted by other coupling traces of the same format
- If traces of a different format exist, all traces of that format will be set as the least numbered trace in that format
- Once enabled, the scale settings for all coupling traces of the same format can be changed with any coupling trace in the working state

Selected Windows:

Available when selecting a window or all methods. The selected window participates in scaling coupling. By default, all windows are selected. Cancel the check box to disable zoom coupling for this window.

About “Auto Scaling” and “Scaling Coupling”:

Automatic scaling using the coupling method affects the work trace in the work window. All traces coupled to this trace will be set with the new scale of the working trace. This will cause some traces to not appear on the screen.

Full automatic scaling using the coupled method

- **Close:** All traces in the working window are automatically scaled separately.
- **Window:** All traces in each selected window are automatically scaled to conform to a common set of scaling factors.
- **All:** All traces in all selected Windows are automatically scaled to conform to a common set of scaling factors.

6.8.3 Electrical delay

Electrical delay is a mathematical function that simulates the variable length of a lossless transmission line. Linear phase shifts through the device can be compensated using the electrical delay function. Use this feature to determine only the linear phase deviation of the device. Electrical delay can be set separately for each measuring trace.

Operating steps:

Press **Scale**, use the knob or arrow key to bring focus to the **Electrical Delay** parameter item. Press **ENTER** or Knob to enter the editing state. After the editing is completed, move the cursor to the specified position by up and down direction keys or Knob. Press **ENTER** or Knob to select the current option.

Delay time: Specifies the value of the delay added or removed, expressed in time or distance. This compensates for the linear phase shift through the device. Electrical delay can be set separately for each measuring trace.

Speed coefficient: Specify the velocity factor applied to the device media inserted after measurement calibration. The value is 0.66 for polyethylene insulated cables and 0.7 for PTFE insulators. 1 corresponds to the speed of light in a vacuum.

Distance unit: Select meters, inches, or feet. When you change this value, the step size does not change automatically.

6.8.4 Amplitude offset and amplitude slope

The “amplitude offset” allows the amplitude (rather than phase) data to be offset by a fixed or slope value in Db. The amplitude offset setting affects only the work trace. If the display format is “Linear Amplitude” or “Real Number” (unitless), the dB is converted and the correct offset is implemented.

Operating steps:

Press **Scale**, use the knob or arrow keys to bring focus to the **Constants** → **Mag Offset / Mag Slope** parameter item.

Press **ENTER** or Knob to enter the editing state. After the editing is completed, move the cursor to the specified position by up and down direction keys or Knob. Press **ENTER** or Knob to select the current option.

Amplitude deviation: Offset the entire data trace at the specified value.

Margin slope: Offset the data trace by some value that changes with frequency. The offset slope starts at 0 Hz.

6.8.5 Phase deviation

Phase offset mathematically adjusts the phase measurement to a specified degree (up to 360°). This feature can be used in the following ways:

- Improved display of phase measurements. This is the same way as changing the reference level in the amplitude measurement. Change the phase response to the center or align the response on the screen.
- Simulate Projection phase shift in measurements. For example, if you know that you need to add a cable and that the length of the cable will add a certain phase shift to the measurement, you can use a phase shift to increase the length and simulate the entire device measurement.

Key operation:

Press **Scale**, use the knob or arrow keys to bring focus to the **Constants** → **Phase Offset** parameter item. Press **ENTER** or Knob to enter the editing state. After the editing is completed, move the cursor to the specified position by up and down direction keys or Knob. Press **ENTER** or Knob to select the current option.

6.8.6 Divisions

Sets the number of divisions on the Y axis. An even number from 4 to 30 must be used. Once set, it is commonly applied to all the traces displayed in the linear scale type on the Y axis within that window.

Operating steps:

Press **Scale**, use the knob or arrow keys to focus on the **Advanced** → **Divisions** parameter item. Press **ENTER** or Knob to enter the editing state. Set the value of the Y-axis divisions in the Cartesian coordinate format. After the editing is completed, move the cursor to the specified position by up and down direction keys or Knob. Press **ENTER** or Knob to select the current option. Range: even numbers from 4 to 30. Divisions do not apply in polar coordinates, Smith chart formats and logarithmic scale type.

6.8.7 Scale type

The scale types include linear scale and logarithmic scale, which are expressed as the scale distribution of the Y axis in the coordinate system. In a logarithmic scale type, the upper and lower limits of the Y-axis determine how the data trace is displayed on the VNA screen. The scale type can be set separately for each measuring trace.

Operating steps:

Press **Scale**, use the knob or arrow keys to focus on the **Advanced** → **Scale Type** parameter item. Press **ENTER** or Knob to enter the editing state. After the editing is completed, move the cursor to the specified position by up and down direction keys or Knob. Press **ENTER** or Knob to select the current option.

Note: The logarithmic scale type can only be selected when the display format is linear magnitude scheme, real number format or imaginary number format. Other formats are linear scale type.

Scale type:

- Linear Scale Type
- Log Scale Type

Linear: Y-axis scale linear distribution. The display mode can be set by setting scale, reference level and position.

Log: The Y-axis scale is logarithmic. The display range can be set by setting the maximum and minimum values of the Y axis.

Max Value: Set the upper limit of the Y-axis in the logarithmic scale type.

Min Value: Set the lower limit of the Y-axis in the logarithmic scale type.

6.9 Avg BW

6.9.1 Overview

The dynamic range is the finite difference between the maximum input power level and the minimum measurement power level (noise floor) of the analyzer. In evaluating a characteristic accompanied by a large change in the amplitude (the start and stop band of a filter for example), it is important to increase the dynamic range. The noise floor can be reduced by narrowing the IF bandwidth or turning on Sweep Averaging.

For minimizing very low noise, Averaging is more effective than reducing IF bandwidth. Generally, Averaging takes slightly longer than IF bandwidth reduction to lower noise, especially if many averages are required. Also, changing the IF bandwidth after calibration results in uncertain accuracy.

6.9.2 Averaging

Averaging is a feature that the VNA averaging on each data point before stepping to the next data point. You determine the number of measurements by setting the averaging factor. The higher the averaging factor, the greater the amount of noise reduction.

Averaging setting:

Press the “Avg BW” key, then enter the Averaging and Bandwidth menu.

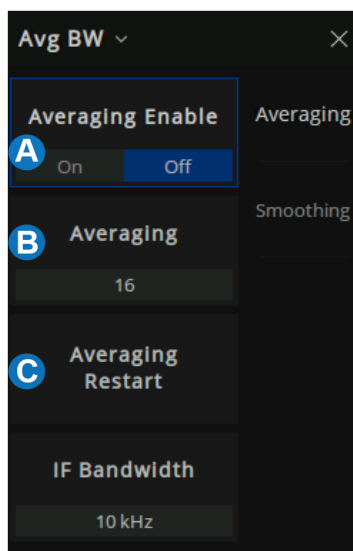

Figure 6-7 Avg BW menu

- A. Averaging Enable.
- B. Sweep Averaging factor. (an integer between 1 and 999)
- C. Averaging Restart. Restart the Sweep Averaging from 1.

6.9.3 IF Bandwidth

The received signal of VNA is converted from its source frequency to a lower intermediate frequency (IF). Reducing the IF receiver bandwidth reduces the effect of random noise on a measurement. Each tenfold reduction in IF bandwidth lowers the noise floor by 10 dB. However, narrower IF bandwidths cause longer sweep times.

IF Bandwidth setting:

1. Using the Softkey for setting: Press the “Avg BW” key, Press “Avg BW” > Averaging > IF Bandwidth > Enter the IF Bandwidth value.

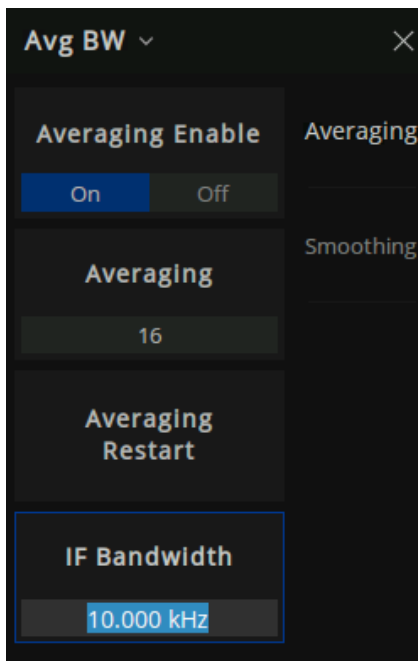

Figure 6-8 Set the IF from the menu bar

- 2. Using a mouse for setting: Click the “BW=xx” icon on the menu bar and select IF Bandwidth.

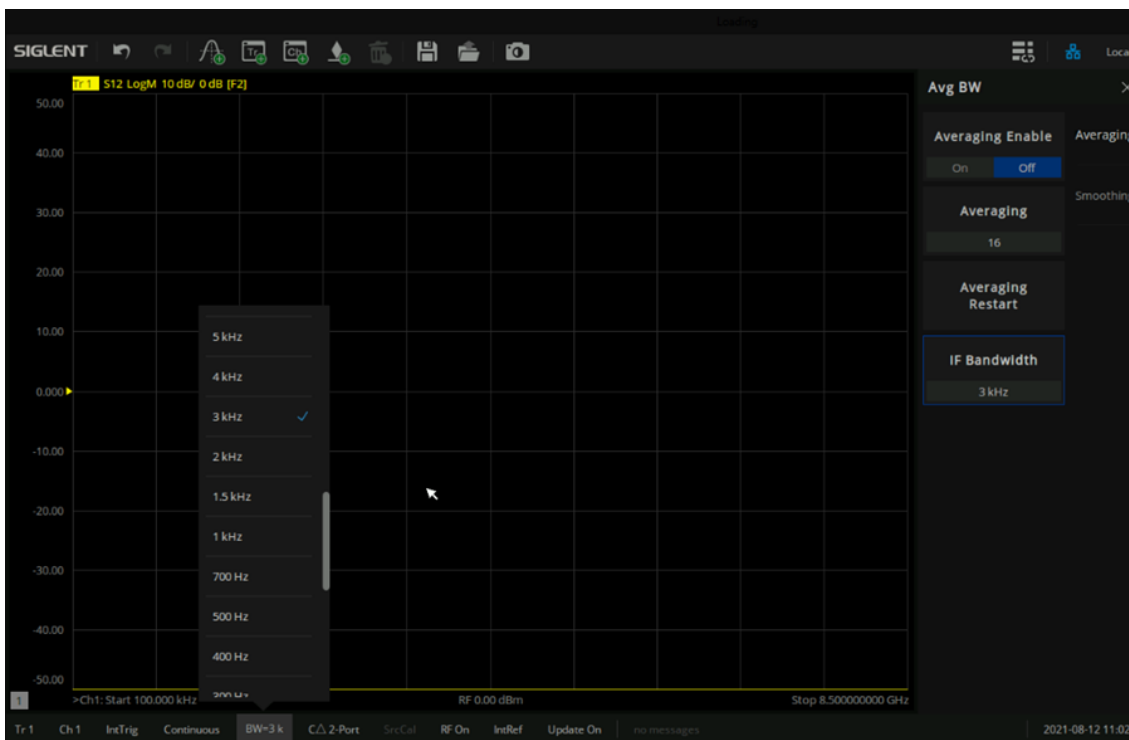

Figure 6-9 Set the IF from the status bar

6.9.4 Smoothing

Trace smoothing averages several adjacent data points to smooth the displayed trace. The number of adjacent data points that get averaged together is also known as the smoothing aperture. You can specify the aperture as either the number of data points or the percentage of the x-axis span.

Trace Smoothing reduces the peak-to-peak noise values on broadband measured data. It smooths trace noise and does not increase measurement time significantly.

Smoothing setting:

Using the Softkey for setting: Press the “Avg BW” key, “Avg BW” > Smoothing then enter the Smoothing menu.

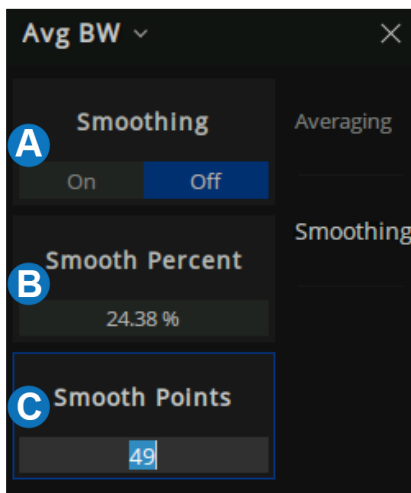

- A. Smooth On|Off When is On, applies smoothing to the displayed trace.
- B. Percent of Smooth: Specify the percent of the swept stimulus span to smooth. For example, for a trace that contains 100 data points, and a smoothing percent of span = 11%, then the number of data points that are averaged is 11.
- C. Smooth Points: Specify the number of adjacent data points to average.

Figure 6-10 Smoothing menu

Tips:

- Start with a high number of display points and reduce until you are confident that the trace is not giving misleading results.
- Do not use smoothing for high-resonance devices, or devices with wide trace variations.
- It may Smoothing is set independently for each trace.

6.10 Preset instructions

Invokes preset Settings to restore system Settings to the specified just started state.

Operating instructions:

- Preset types are available through **Preset** → **Preset Option**, Select “Default”, “Last”, or “User”.
- Press the **Preset** key, and the device invokes either default Settings or user Settings.

Table 6-1 Some default setting values

Take SNA5084A for example:

Parameter name	Parameter value
RF Power	
RF state	ON
RF level	0 dBm
Signal output port	Port 1
Port coupling	ON
Frequency	
Frequency range	100 kHz-8.5 GHz
Frequency step size	42.4995MHz
Frequency points	201
Sweeping	
Sweeping points	201
Sweeping type	Linear frequency
Sweeping time delay	0 s
Sweeping mode	automatic
Trigger	
Trigger mode	continuous
Trigger source	internal
Measurement	
S parameter	S11
Display format	
Data display format	Log Mag
Scale	
Scale	10 dB
Reference level	0 dB

reference position	5
Scale coupling	OFF
Delay time	0 s
Delay distance	0 m
Distance unit	meter
Speed coefficient	1
System impedance	50 Ω
Phase deviation	0°
Amplitude deviation	0 dB
Average	
Average state	OFF
Smooth state	OFF
Calibration	
Calibration state	Unloaded calibration data

7 Measurement Calibration

7.1 Overview

Usually, DUTs can't be measured directly and accurately due to cabling, adapters, probes, and more. Calibration, compensation, and fixture simulation are introduced to help achieve higher accuracy. These functions meet different measurement requirements, but they all can be expressed as a matrix multiplication of the scattering parameter matrix and a specific compensation matrix. The order of the matrix multiplication has a large influence on the result. So it's important to understand the order of applying these functions and to design a suitable physical connection to the DUT and expected measurement network.

Internal source power calibration and receiver calibration are applied before the scattering parameter calculation, and the S parameter calibration is applied to the calculation results. This provides the highest measurement accuracy at the calibration reference plane.

From the reference plane, the order of applying functions is as follow:

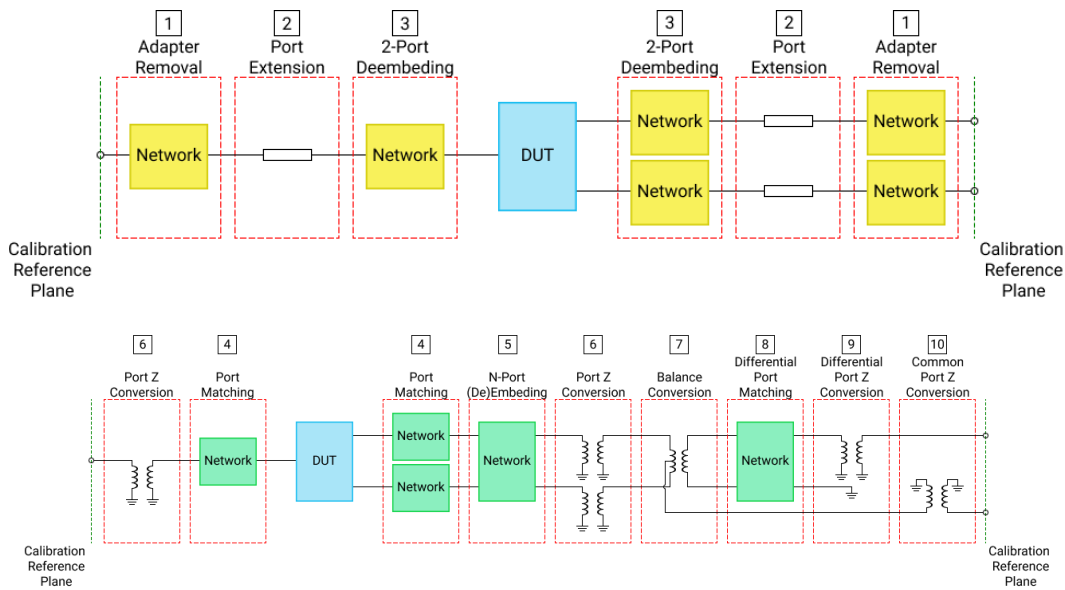

Figure 7-1 The order of applying functions

At first, adapter removal/ insertion, port extension, 2-port de-embedding are applied to remove the needless networks in the physical connections of the DUT and move the measurement plane to the DUT. Then, Port match, N-port embedding/ de-embedding, port impedance conversion are used to embed or de-embed expected virtual networks. If balance scattering parameters are measured, balance conversion, differential port match, differential port impedance conversion, common port impedance conversion can be helpful if needed.

7.2 Calibration type

The following table is a comparison of some common S-parameter calibration types:

Table 7-1 S-parameter calibration types

Calibration type	precision	Allow pass-through methods
TRL	Very high	All, except the unknown direct
SOLT	high	All
Enhanced Response	high	Defined through or flush through (zero-length through)
Port 1 (reflection)	high	Not Applicable
Open Circuit Response/ Short Circuit Response	low	Not Applicable
Direct Response	low	Known through or flush through (zero-length through)

The following are the actual S-parameter calibration types used by this vector network analyzer.

Table 7-2 The vector network analyzer S parameter calibration types

Port number	Calibration type	Calibration item
Port 1	Response (Open)	Open, Load (optional)
	Response (Short)	Short, Load (optional)
	OSL	Open, Short, Load
Port 2	Response (Thru) 1 → 2	Thru, Isolation (optional)
	Response (Thru) 2 → 1	Thru, Isolation (optional)
	Enhanced Response (Thru) 1 → 2	Port1:Open, Short, Load Thru, Isolation (optional)
	Enhanced Response (Thru) 2 → 1	Port2:Open, Short, Load Thru, Isolation (optional)
	SOLT	Port1: Open, Short, Load Port2: Open, Short, Load Thru, Isolation (optional)
	SOLR	Port1: Open, Short, Load Port2: Open, Short, Load

		Unknown Thru, Isolation (optional)
	TRL	Port1: Reflect (Open or Short) Port2: Reflect (Open or Short) Thru, Line

TRL:

Application: Used to precisely calibrate any pair of ports when no calibration kits are readily Available.

Note: Difference matching calibration may be required (**Delta Match Cal**)

Overall accuracy: Very high

Calibration kits required: Straight, reflection, line, or similar combination

Corrected system error:

- Directivity
- Isolation
- Frequency response
transmission tracking
- Source match
- Load match
- Frequency response
reflection tracking

SOLT :

Application: Used to accurately calibrate any number of ports

Overall accuracy: High

Required calibration kits: short circuit, open circuit, load, through) or ECAL electronic calibration parts module

- Directivity
- Isolation
- Frequency response
transmission tracking
- Source match
- Load match
- Frequency response
reflection tracking

Enhanced Response:

Application: Calibrate two ports when only one direction (forward or reverse) is needed for measurement. Because no secondary sweep is required, the measurement is faster.

- The reflection calibration element (open, short circuit, or load) is connected to the source port to be calibrated.

- The defined through-through or flush through-through calibrator kits are connected between port pairs.
- The mechanical calibration kit is much faster than the SOLT. You can also use ECAL.

To select an enhanced response, do the following:

Keys operation: Press **Cal**, using the knob or arrow keys, to focus on the **Cal** → **Basic Cal** parameter item. Select **port1 & port2** from the interface menu, Select **Enhanced Response 1 → 2 or Enhanced Response 2 → 1** in the **Cal Type**, Press **ENTER** or the knob to select the current option.

Overall accuracy: High

Required calibration kits: Short circuit, open circuit, load, defined through or flush through

Corrected system error:

- Directivity (Source port)
- Isolation
- Frequency response transmission tracking (receiver port)
- Source match (source port)
- Load matching (receiver port) is used only to generate transmission trace items
- Frequency response reflection tracking (source port)

One port (reflection):

Application: Used to accurately calibrate any test port suitable for reflection measurement only

Overall accuracy: High

Required calibration kits: Short circuit, open circuit, and load or ECAL module

Corrected system error:

- Directivity
- Frequency response reflection tracking
- Source match

Open circuit response / short circuit response:

Application: Quick calibration of any test port suitable for reflection measurement only

Overall accuracy: Low

Calibration kits required: Open circuit or short circuit.

Corrected system error:

- Frequency response reflection tracking

Direct / Transport Tracking (isolation optional):

Application: Quick calibration of any pair of test ports suitable for transmission measurements only. Isolation calibration is generally not recommended.

Overall accuracy: Low

Required calibration kit: Through

Isolation: Each load corresponds to a vector network analyzer test port.

Corrected system error:

- Isolation
- Frequency response transmission tracking

Power calibration types: Transmitter calibration (internal source power calibration) and receiver calibration.

7.3 Checking Calibration Status

7.3.1 Execution Status of Error Correction for Each Channel

User can check the execution status of error correction for each channel with the error correction status.

The error correction status is indicated in the channel status bar in the lower part of the window by the symbols in the below table.

Symbol	Execution Status of Error Correction	Accuracy
No Cor	Error correction: Off (No Correction)	Lowest
C N-Port	Error correction: On (Full N Port Correction)	Highest
C* N-Port	Error correction: On (Interpolation is being executed)	Uncertain
CΔ N-Port	Error correction: On (Stimulus settings change)	Uncertain

No Cor

It indicates there is no Correction. The following will cause the VNA to turn Error Correction OFF for the channel:

- Decrease the start frequency.
- Increase the stop frequency.
- Increase number of points
- Change sweep type.

C N-Port

Full N Port correction, where N is the number of fully calibrated ports. This correction is applied to S Parameters.

C* N-Port

"C* " appears in the status bar when a measurement is being interpolated. Interpolation occurs when you change any of the following settings:

- Start frequency increased
- Stop frequency decreased
- Number of points

Note: Decreasing the start frequency, or increasing the stop frequency will always turn correction OFF.

CΔ N-Port

"CΔ" appears in the status bar when one or more of the following stimulus settings change. The resulting measurement accuracy depends on which parameter has changed and how much it has changed. For optimum accuracy, recalibrate using the new settings.

- Sweep time
- IF Bandwidth
- Port power

7.3.2 Execution Status of Error Correction for Each Trace

User can check the status of the error correction actually executed for each trace with the trace status area.

For a trace for which error correction is executed, the applied calibration type is indicated in the trace status area by the symbols in the table below.

Symbol	Calibration type
RO	Open response calibration
RS	Short response calibration
RT	Thru response calibration
ER	Enhanced response calibration
F1	1-port calibration
F2	Full 2-port calibration/2-port TRL calibration
F3	Full 3-port calibration/3-port TRL calibration
F4	Full 4-port calibration/4-port TRL calibration

Note: If none of the symbols described above is displayed, error correction is not executed for the trace.

7.3.3 Acquisition Status of Calibration Coefficient for Each Channel

User can check the acquisition status of the calibration coefficient for each channel with the calibration property.

The calibration property displays the acquisition status of the calibration coefficient between test ports for each channel in matrix format. The following figure shows an example of when the calibration coefficients have been acquired for the full 2-port calibration between test ports 1 and 2, the response calibration for test port 3, and the response calibration (THRU) between test ports 4 and 3.

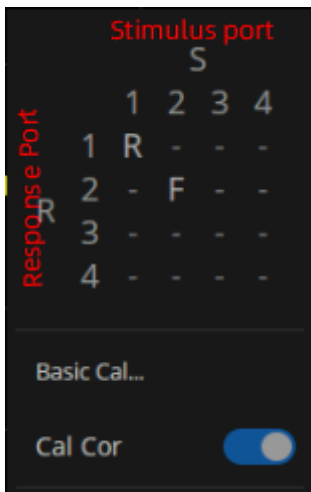

F : Full Port Calibration

R : Response Calibration

-- : Nothing

7.3.4 Procedure to turn on/off calibration property display

There are two methods to turn on/off the display of calibration property.

Method 1: Click the channel error correction execution status symbol in the channel status bar to open and close, as shown in the left figure below.

Method 2: Press "Cal" on the front panel > Cal > Correction, as shown in the right figure below.

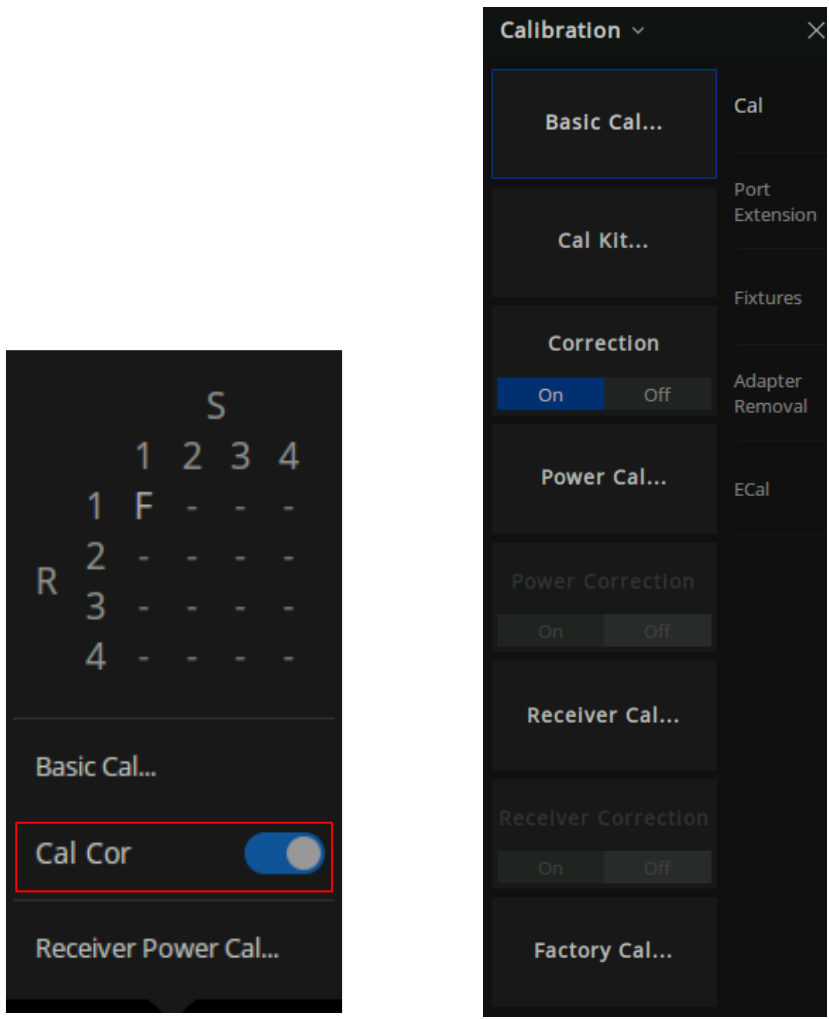

7.4 Basic Cal

S parameter user calibration can be started after selecting the required S parameter calibration type in the calibration wizard and setting the corresponding parameters.

Operating instructions:

Press the **Cal** key, use the knob or the arrow key to make the focus fall on **Basic Cal**, and press **Enter** to enter the setting interface of the calibration kit:

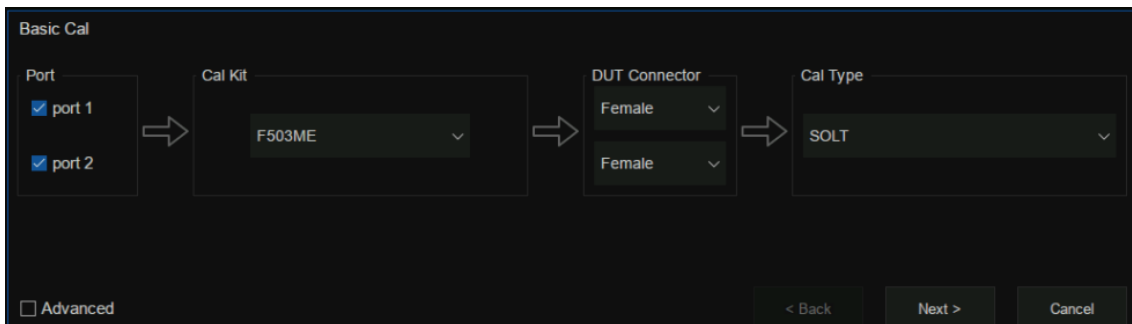

Figure 7-2 Calibration wizard interface

Select the number of ports to be calibrated from the port menu in the calibration wizard interface, and select the corresponding calibration kit model in the Cal Kit pull-down option. Select the gender properties of the calibration connector from the DUT Connector drop-down option, and select the corresponding calibration method from the Cal Type drop-down option, as shown in the figure below:

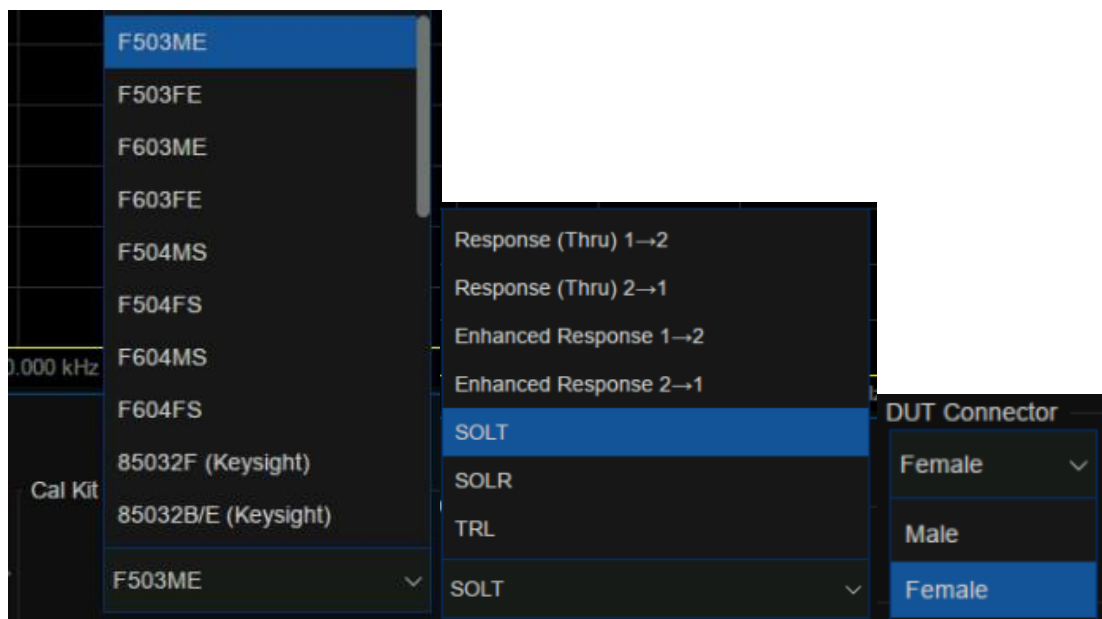

Figure 7-3 Calibration wizard interface

After the calibration is set, a specific calibration item interface will appear as shown in the figure below. Here, taking the two-port SOLT calibration method as an example, it includes several calibration items: OPEN, SHORT, LOAD, THRU, ISOLATION, among which the ISOLATION calibration item may not be calibrated. There is no sequence relation between these calibration terms. Simply select the corresponding calibration kit and click the corresponding calibration item menu on the interface.

After completion of the corresponding calibration item, the percentage of calibration progress will be

displayed in the lower-left corner of the interface. When all the calibration steps are completed, the calibration progress bar will show 100%. Click Finish to exit the calibration interface, calibration results are automatically loaded in the current screen.

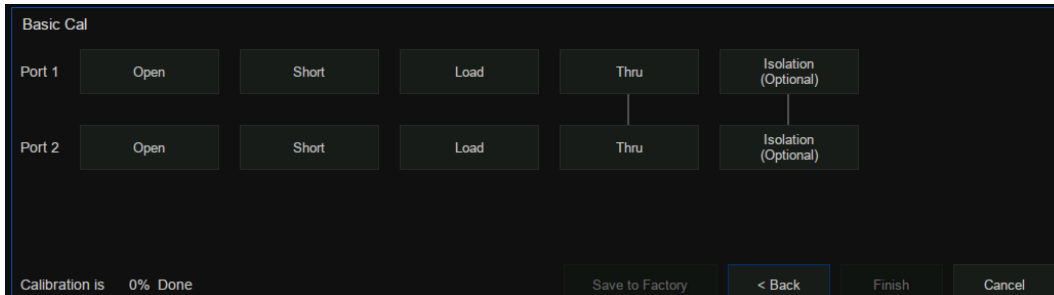

Figure 7-4 Calibration wizard interface

To Save the current calibration data for future use, press the **Save Recall** button and use the knob or arrow keys to bring the focus to the **Save State** menu bar. Select **State+Cal Data** from the **Save Type** drop-down option, click **Save State As** and enter the file name, and click **OK** to Save the current calibration Data and the current setting State.

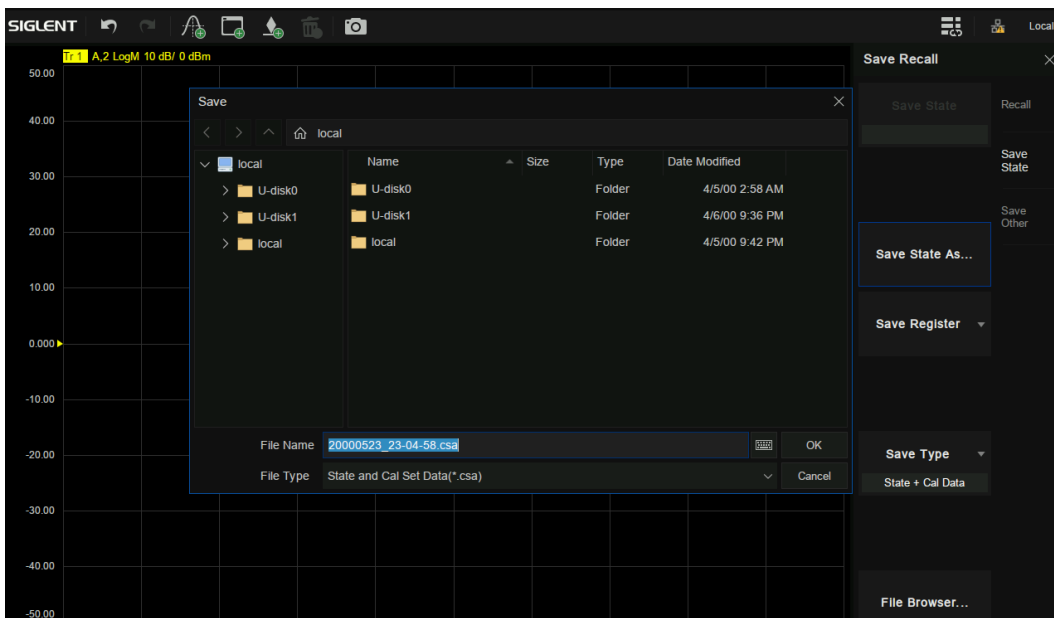

Figure 7-5 Calibration wizard interface

7.4.1 Open Response Calibration

When a single port is used for open-circuit response calibration, the reflection tracking error in the

error model of the test device can be calculated by only connecting the OPEN calibration element to the test port. If the LOAD calibration element is used for isolation calibration at the same time, the directional error can be calculated.

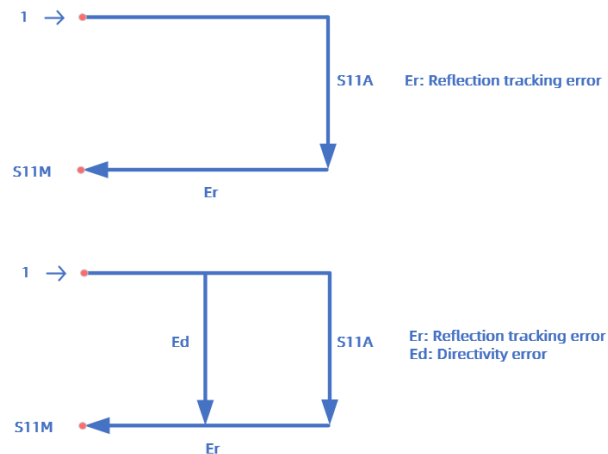

Figure 7-6 Schematic diagram

Operating steps:

1. **Preset** vector network analyzer.
2. Set internal source output power, IF bandwidth, sweep points, test frequency band and other parameters.
3. Select **Cal** → **Basic Cal** to enter the Settings screen.
4. Select only **Port1** or **Port2**, select the required calibration kit in the **Cal Kit**, select the Type of calibration element connector, **Female** or **Male**, in the **DUT Connector**, select **Response(Open)** in the **Cal Type**, and click **Next** to proceed to the next step.
5. Connect the OPEN calibration element to the test port according to the interface prompts, click **Open** for calibration, and click **Finish** to exit the calibration interface after calibration, complete the calibration, and save the calibration data.

7.4.2 Short circuit response calibration

Like the open-circuit response calibration, the single-port short-circuit response is connected to the port with the SHORT calibration element, and the reflection tracking error can be calculated. If the LOAD calibration element is used for isolation calibration at the same time, the directional error can also be calculated.

Operating steps:

1. **Preset** Vector network analyzer.
2. Set internal source output power, IF bandwidth, sweep points, test frequency band and other parameters.
3. Select **Cal** → **Basic Cal** to enter the setting interface.
4. Select only **Port1** or **Port2**, select the required calibration kit in the **Cal Kit**, select the Type of connector, **Female** or **Male**, in the **DUT Connector**, select **Response(Short)** in the **Cal Type**, and click **Next** to proceed to the next step.
5. Connect the Short calibration element to the test port according to the interface prompts, click **Short** for calibration, and click **Finish** to exit the calibration interface, complete the calibration, and save the calibration data.

7.4.3 Full 1 port OSL calibration

All 1-port OSL calibration connects the OPEN, SHORT, and LOAD calibration elements to the test ports in turn to calculate the reflection tracking error, directional error, and source matching error in the error model of the test device.

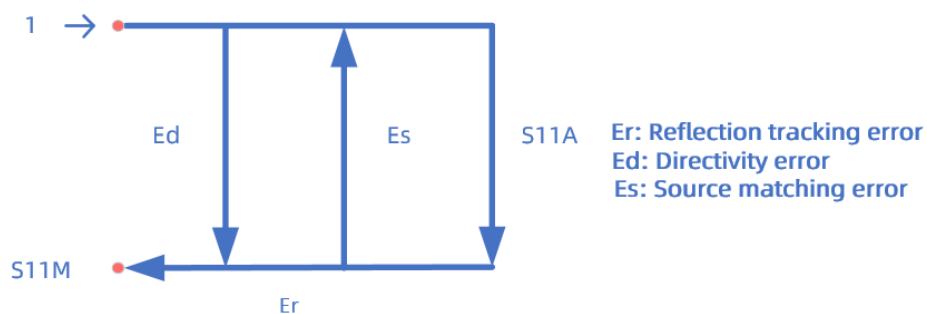

Figure 7-7 Schematic diagram

Operating steps:

1. **Preset** Vector network analyzer.
2. Set internal source output power, IF bandwidth, sweep points, test frequency band, and other parameters.

3. Select **Cal** → **Basic Cal** to enter the setting interface.
4. Select only **Port1** or **Port2**, select the desired calibration kit in the **Cal Kit**, select the Type of calibration connector, **Female** or **Male**, in the **DUT Connector**, select **OSL (Open, Short, Load)** in the **Cal Type**, and click **Next** to proceed to the next step.
 - Connect the OPEN calibration element to the test port according to the interface prompts.
 - Click Open for calibration
 - Then connect the SHORT calibration element to the test port, click Short for Calibration.
 - Finally, connect the LOAD calibration element to the test port, click the Load for Calibration.
 - After the calibration, click Finish to exit the calibration interface, complete the calibration, and save the calibration data.

7.4.4 Transmission response calibration (two ports)

Two-port transmission response calibration is to connect the THRU calibration kit between two ports to calculate the transmission tracking error in the test device error model. If the LOAD calibration kit is used for isolation calibration at the same time, isolation error (crosstalk error) can also be calculated.

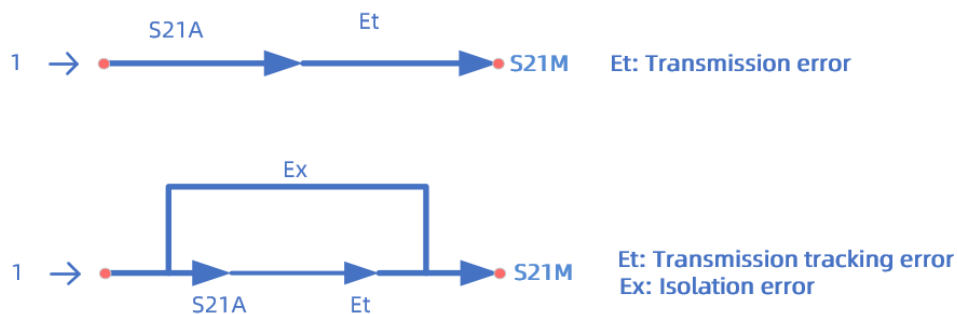

Figure 7-8 Schematic diagram

Operating steps:

1. **Preset** Vector network analyzer.
2. Set internal source output power, IF bandwidth, sweep points, test frequency band, and other parameters.
3. Select **Cal** → **Basic Cal** to enter the setting interface.
4. Select both **Port1** and **Port2**, select the desired calibration kit in the **Cal Kit**, select the Type of

calibration connector, **Female** or **Male**, in the **DUT Connector**, Select **Response (Thru) 1 → 2** or **Response(Thru) 2 → 1** in the **Cal Type** (the difference is to test S21 or S12), and click **Next** to proceed to the next step.

5. Connect the **Thru** calibration element between the test ports according to the interface prompts, click **Thru** for calibration, and click **Finish** to exit the calibration interface, complete the calibration, and save the calibration data.

7.4.5 Enhanced response calibration (two ports)

Two-port enhanced response calibration connects the Thru calibration element between two ports, and only connects the Open, Short, and Load on one port for calibration, or connects the LOAD element to both ports for isolation calibration.

Operating steps:

1. **Preset** Vector network analyzer.
2. Set internal source output power, IF bandwidth, sweep points, test frequency band, and other parameters.
3. Select **Cal** → **Basic Cal** to enter the setting interface.
4. Select both **Port 1** and **Port 2**, select the desired calibration kit in the **Cal Kit**, select the type of calibration connector, **Female** or **Male**, in the **DUT Connector**, Select **Enhanced Response 1 → 2** or **Enhanced Response (Thru) 2 → 1** in the **Cal Type** (the difference is that S21 or S12 is tested during THRU calibration), and click **Next** to proceed to the next step.
5. According to the interface prompts, connect Open, Short, and Load on a test port to complete the calibration successively, and then connect the THRU calibration kit between the two ports to perform the **Thru** calibration. After the calibration is completed, click **Finish** to exit the calibration interface, complete the calibration and save the calibration data.

7.4.6 SOLT calibration (two ports)

Two-port SOLT calibration connects the Open, Short, and Load calibration elements to each test port in turn and the THRU calibration kit between the two test ports. All 12 error parameters of the two ports can be calculated, including 6 forward and 6 reverse errors, including directional, source matching, reflection tracking, transmission tracking, isolation (crosstalk), and load matching errors. It is also possible to connect the LOAD element to both ports for isolation calibration.

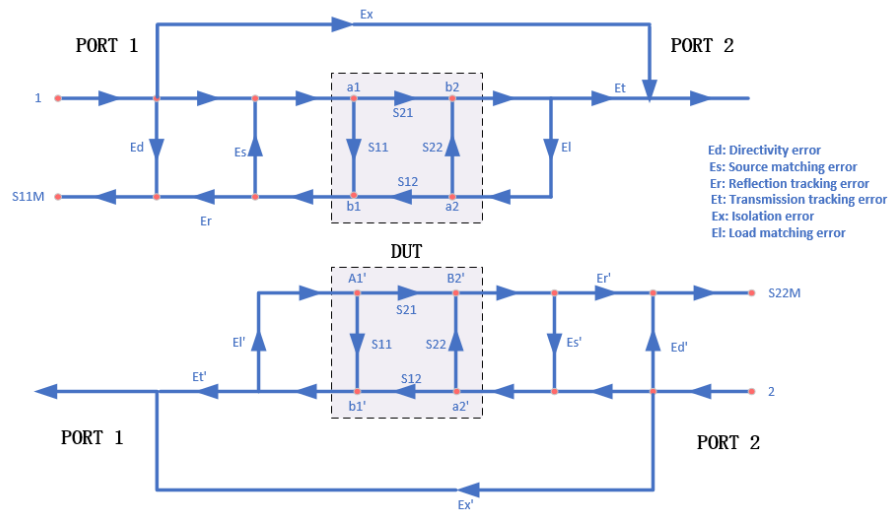

Figure 7-9 Error model diagram

Operating steps:

1. **Preset** vector network analyzer.
2. Set internal source output power, IF bandwidth, sweep points, test frequency band, and other parameters.
3. Select **Cal** → **Basic Cal** to enter the Settings screen.
4. Select both **Port 1** and **Port 2**, select the desired calibration kit in the **Cal Kit**, select the type of calibration connector, **Female** or **Male**, in the **DUT Connector**, select **SOLT** in the **Cal Type**, and click **Next** to proceed to the next step.
5. According to the interface prompts, connect the Open, Short, and Load calibration elements to Port 1 successively, and click the corresponding **Open**, **Short**, and **Load** items successively to complete the Port 1 calibration.
6. According to the interface prompts, connect the Open, Short, and Load calibration elements to Port2 successively, and click the corresponding **Open**, **Short**, and **Load** items successively to complete the Port 2 calibration.
7. According to the interface prompts, connect the THRU calibration kit between the two ports to perform the **Thru** calibration.
8. After the calibration, click **Finish** to exit the calibration interface, complete the calibration, and save the calibration data.

7.4.7 SOLR unknown through calibration (two ports)

In contrast to the two-port SOLT calibration, the error term in the test unit can be calculated without knowing the S-parameter of the THRU straight-through calibration. The calibration method is similar to that of SOLT in that it is possible to connect the LOAD to both ports for isolated calibration.

Operating steps:

1. **Preset** vector network analyzer.
2. Set internal source output power, IF bandwidth, sweep points, test frequency band, and other parameters.
3. Select **Cal** → **Basic Cal** to enter the Settings screen.
4. Select both **Port 1** and **Port 2**, select the desired calibration kit in the **Cal Kit**, select the Type of calibration Connector, **Female** or **Male**, in the **DUT Connector**, select **SOLR** in the **Cal Type**, and click **Next** to proceed to the next step.
5. According to the interface prompts, connect the Open, Short, and Load calibration elements to Port 1 successively, and click the corresponding **Open**, **Short**, and **Load** items successively to complete the Port 1 calibration.
6. According to the interface prompts, connect the Open, Short, and Load calibration elements to Port 2 successively, and click the corresponding **Open**, **Short**, and **Load** items successively to complete the Port 2 calibration.
7. Connect the THRU calibration kit between the two ports according to the interface prompts. The parameters of the THRU do not have to be known. Carry out unknown through **Thru** calibration.
8. After the calibration, click **Finish** to exit the calibration interface, complete the calibration, and save the calibration data.

7.4.8 TRL Direct Reflection Transmission Line Calibration (Two Ports)

The two-port TRL calibration method does not need to know the index parameters of the calibration kit, and all the error items in the error model of the test device can be figured out through three simple connection methods. TRL calibration scheme will use the THRU straight through calibration element, reflection calibration kit (Open or Short), and a small section of transmission line.

Operating steps:

1. **Preset** vector network analyzer.

2. Set internal source output power, IF bandwidth, sweep points, test frequency band, and other parameters.
3. Select **Cal** → **Basic Cal** to enter the Settings screen.
4. Select both **Port 1** and **Port 2**, select the desired calibration kit in the **Cal Kit**, select the Type of calibration kit Connector, **Female** or **Male**, in the **DUT Connector**, select **TRL** in the Cal Type, and click **Next** to proceed to the next step.
5. According to the interface prompts, connect the THRU calibration kit, Reflect(Open or Short) calibration element, and Line on a Port 1 in turn, and click the corresponding **Thru**, **Reflect**, and **Line** items in turn to complete the Port 1 calibration.
6. According to the interface prompts, connect the THRU calibration element, Reflect(Open or Short) calibration element, and transmission line on a Port 2 in turn, and click the corresponding **Thru**, **Reflect**, and **Line** items to complete the Port 2 calibration.
7. After the calibration, click **Finish** to exit the calibration interface, complete the calibration, and save the calibration data.

7.4.9 Partial Overwrite calibration

When the ports are calibrated, some error items in the error model may be not acceptable. For unacceptable error items, the partial overwrite calibration chooses suitable calibration items to calibrate the ports again. Taking the two-port SOLT calibration as an example, the following describes the partial overwrite calibration for achieving full two-port open calibration after completing full two-port SOLT calibration.

Operating steps:

1. Select **Cal** → **Basic Cal** to enter the Settings screen.
2. Select both **Port 1** and **Port 2**, select the desired calibration kit in the **Cal Kit**, select the type of calibration connector, **Female** or **Male**, in the **DUT Connector**, select **SOLT** in the **Cal Type**, and click **Next** to proceed to the next step.
3. According to the interface prompts, connect the Open calibration element to Port 1, and click the corresponding **Open** item to complete the Port 1 open calibration.
4. According to the interface prompts, connect the Open calibration element to Port 2, and click the corresponding **Open** item to complete the Port 2 open calibration.
5. Click **Overwrite** to finish partial overwrite calibration.

Notes

1. Uncalibrated ports can't be calibrated directly using partial overwrite calibration.
2. Partial overwrite calibration requires that sweep points, IF bandwidth, and other parameters are the same as the values set by the previous calibration method.

7.5 Cal Kit management

7.5.1 Overview

For most applications, the default calibration kit models provide sufficient accuracy for your calibration. However, several situations may exist that would require you to create a custom calibration kit:

- Using a connector interface different from those used in the predefined calibration kit models.
- Using standards (or combinations of standards) that are different from the predefined calibration kits. For example, using three offset SHORTs instead of an OPEN, SHORT, and LOAD to perform a 1-port calibration.
- Improving the accuracy of the models for predefined kits. When the model describes the actual performance of the standard, the calibration is more accurate. For example, A 7 mm LOAD is determined to be 50.4 Ω instead of 50.0 Ω .
- Modifying the THRU definition when performing a calibration for a non-insertable device.
- Performing a TRL calibration.

Operation instructions:

Press “Cal” on the front panel, Cal > Cal > Cal Kit to enter the Manage Cal Kits page. You can edit, import, and create or delete calibration kits.

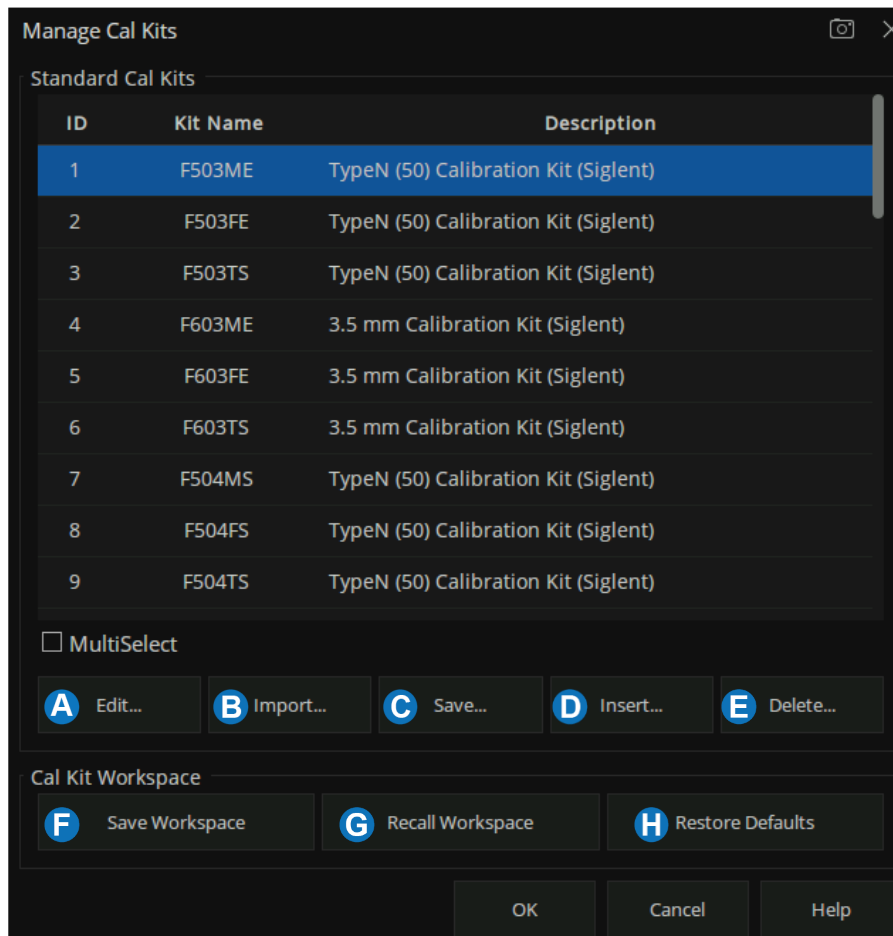

Figure 7-10 Manage Cal Kits

- A. Edit the Existing Cal Kit.
- B. Import the customized Cal Kit.
- C. Save the existing Cal kits and change the file name.
- D. Create a new custom Cal Kit.
- E. Select the Cal Kit.
- F. Save the current Cal kits (both factory and custom).
- G. Recall the Cal Kits.
- H. Restore the default factory Cal kits.

7.5.2 Connector Tab

At the bottom of each Tab, 'OK' is used to save the edited file, and 'Cancel' is used to close the calibration suite edit session and the file will not be saved. "Help" is used to view the Help

documents.

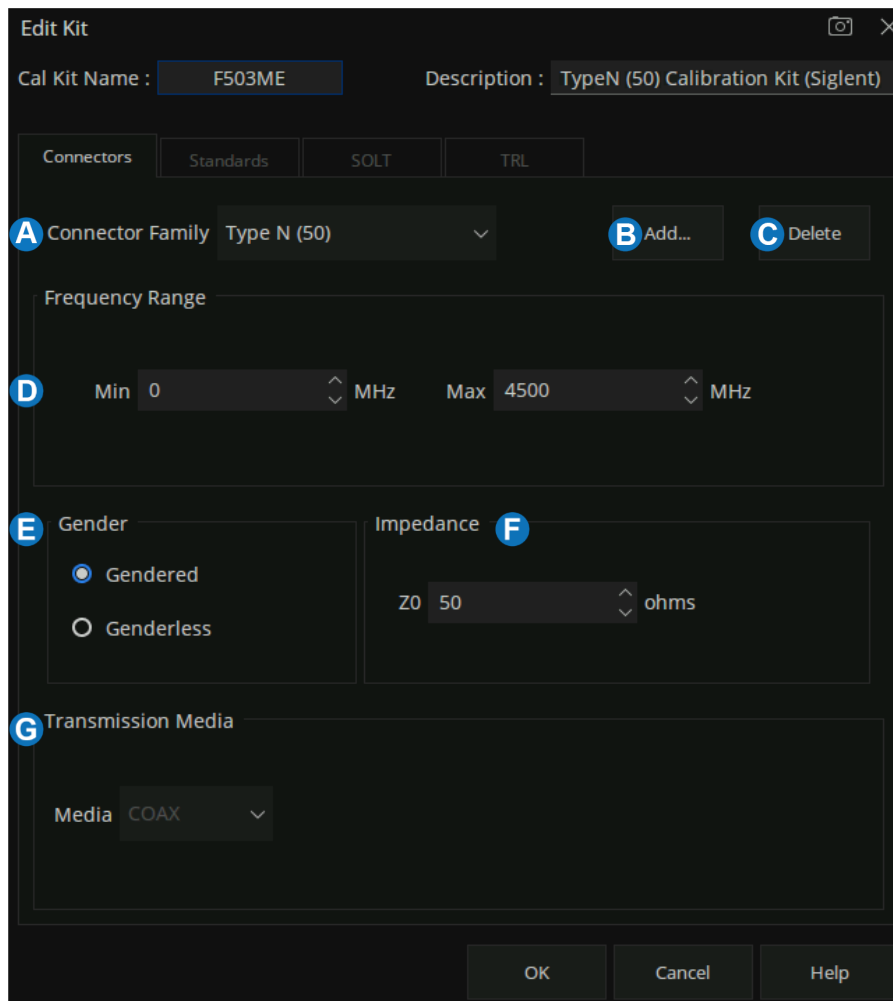

Figure 7-11 The Connectors Tab interface

- A. Connector Family:** Click the down arrow to select the connector family associated with the Cal Kit.
- B. Add:** Starts the Add Connector dialog box which allows you to add a new connector type to the calibration kit.
- C. Select:** The selected connector family.
- D. Frequency Range:** Define the lowest and the highest frequency at which the standard is used for calibration.
- E. Gender:** Gendered or Genderless
- F. Impedance:** Specify the impedance of the standard.

G. Transmission Media: The medium of the connector, COAX or WAVEGUIDE

7.5.3 Standards Tab

Allows you to Add, Edit, or Delete Cal standards in a Cal kit.

- 1) In the “Standard” tab, click “Add” to add the Standard sample.

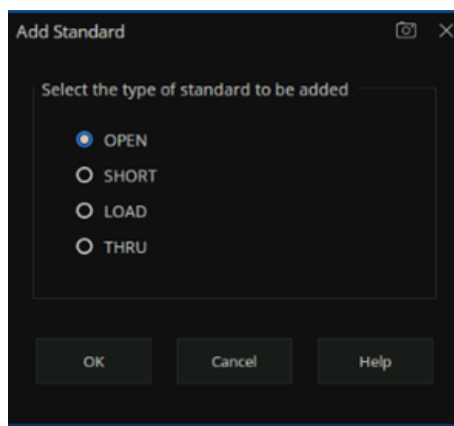

Figure 7-12 add standard interface

- 2) Standards dialog box help, the following fields apply to ALL standard types.

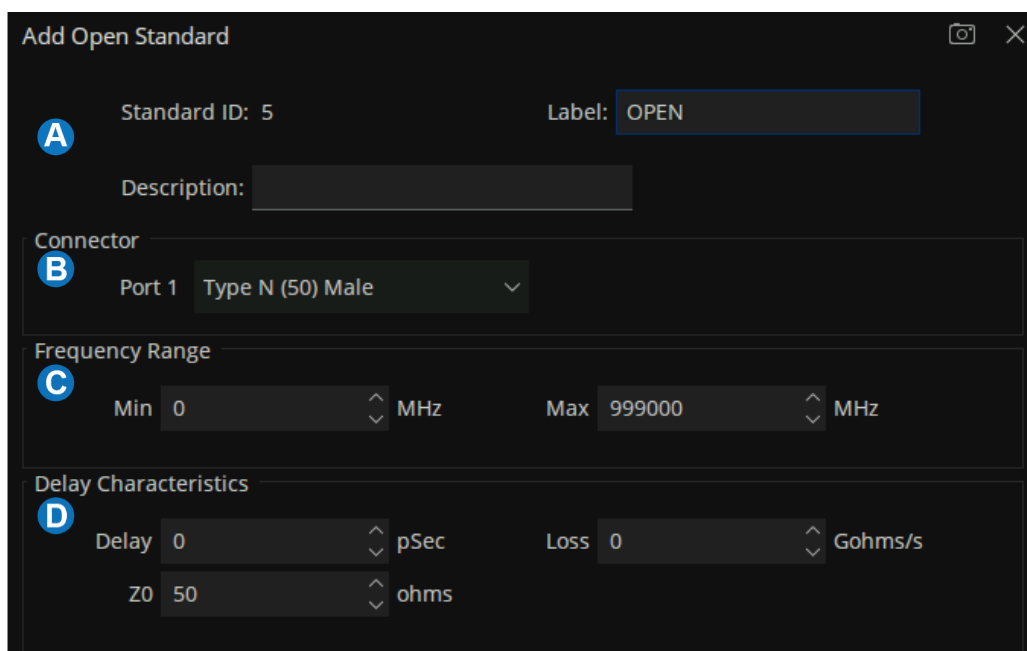

Figure 7-13 The help dialog of the Standard

A. Identification

Standard ID: Number in list of standards

Label: Type of standard. This usually appears in prompts for standards.

Description: Description of standard.

B. Connector

Indicates the type and gender (Male, Female, None) of the standard.

Thru and Isolation standards have two connectors.

C. Frequency Range

Min: Defines the lowest frequency at which the standard is used for calibration.

Max: Defines the highest frequency at which the standard is used for calibration.

D. Delay Characteristics

Delay: Defines the one-way travel time from the calibration plane to the standard in seconds.

Z0: Defines the impedance of the standard.

Loss: Defines energy loss in Gohms, due to skin effect, along a one-way length of coaxial cable.

3) Open Standard

C0, C1, C2, C3: Specify the fringing capacitance.

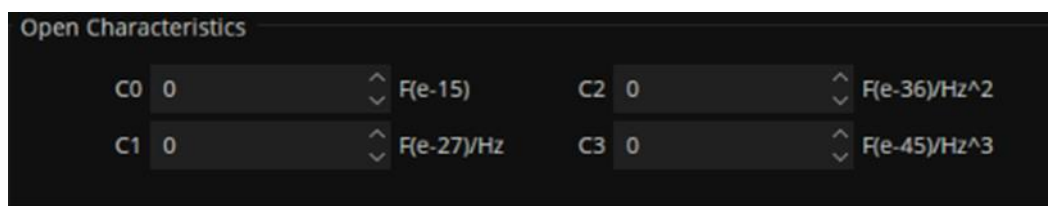

Figure 7-14 Open Characteristics

4) Short Standard

L0, L1, L2, L3: Specify the residual inductance.

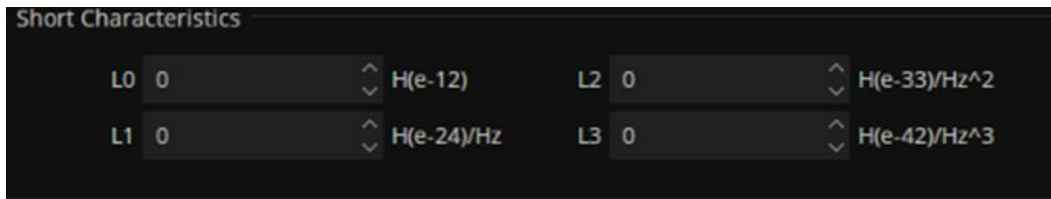

Figure 7-15 Short Characteristics

5) Load Standard

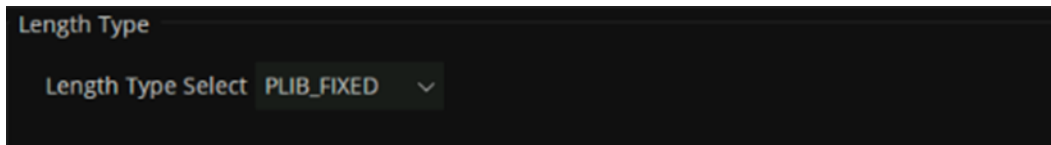

Figure 7-16 load Characteristics

6) THRU Standard

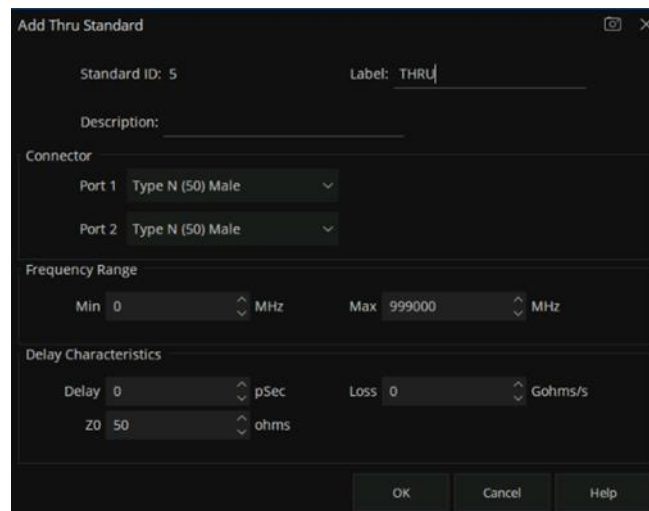

Figure 7-17 THRU Characteristics

7.5.4 SOLT Tab

Allows you to assign single or multiple standards to SOLT Calibration Classes.

- 1) For each Cal Kit Class, select Available Standards from the left list, then click >> to copy the standard to the Cal Kit

- 2) Use Move Up and Move Down to change the ORDER of the standards.

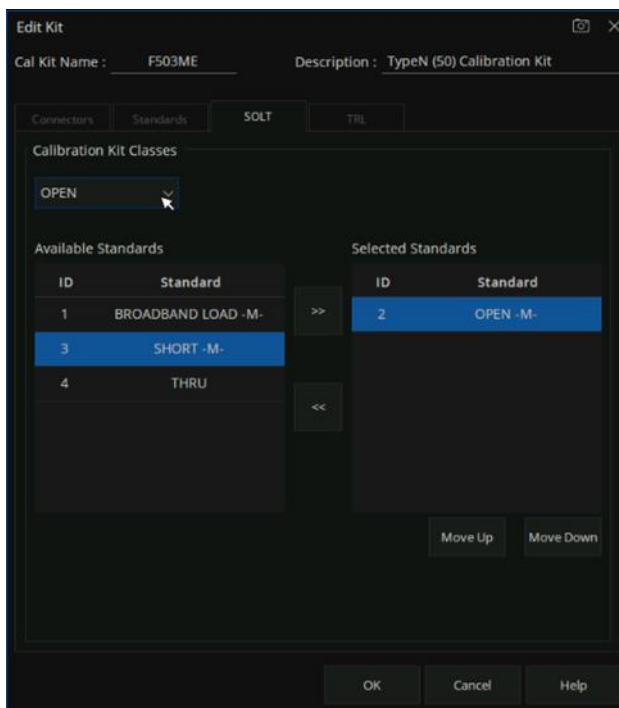

Figure 7-18 SOLT Tab dialog box

7.5.5 TRL Tab

Allows you to assign single or multiple standards to Calibration Classes.

- 1) For each Cal Kit Class, select Available Standards from the left list, then click >> to copy the standard to the Cal kit.
- 2) Use Move Up and Move Down to change the ORDER of the standards.

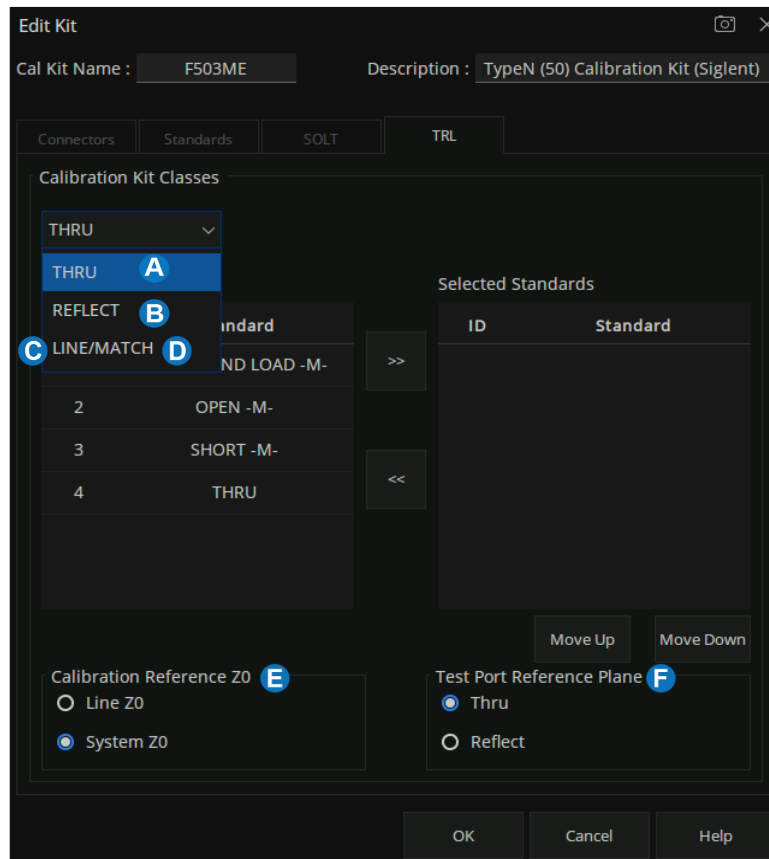

Figure 7-19 TRL dialog box

A. TRL THRU

All THRU calibration methods are supported in a TRL Cal EXCEPT Unknown Thru.

- The THRU standard can be either a zero-length or non-zero length. However, a zero-length THRU is more accurate because it has zero loss and no reflections, by definition.
- The THRU standard cannot be the same electrical length as the LINE standard.
- If the insertion phase and electrical length are well-defined, the THRU standard may be used to set the reference plane.
- The THRU standard and LINE standard have the same characteristic impedance and are perfectly matched. They define the reference impedance of the calibration.
- If a THRU standard with the correct connectors is NOT available, an adapter removal cal can be performed.

B. TRL REFLECT

- The REFLECT standard can be anything with a high reflection, as long as it is the same

when connected to one or more VNA ports.

- The REFLECT standard on each port is identical.
- The actual magnitude of the reflection need not be known.
- The phase of the reflection standard must be known within 1/4 wavelength.
- If the magnitude and phase of the reflection standard are well-defined, the standard may be used to set the reference plane

C. TRL LINE

The LINE and THRU standards establish the reference impedance for the measurement after the calibration is completed. TRL calibration is limited by the following restrictions of the LINE standard

- Must be of the same impedance and propagation constant as the THRU standard.
- The electrical length need only be specified within 1/4 wavelength.
- Cannot be the same length as the THRU standard.
- A TRL Cal with broad frequency coverage requires multiple LINE standards. For example, a span from 2 GHz to 26 GHz requires two lines standards.
- Must be an appropriate electrical length for the frequency range

D. TRL MATCH

If the LINE standard of appropriate length or loss cannot be fabricated, a MATCH standard may be used instead of the LINE.

- The MATCH standard is a low-reflection termination connected to both Port 1 and Port 2.
- The MATCH standard may be defined as an infinite length transmission line OR as a 1-port low reflect termination, such as a load.
- When defined as an infinite length transmission line, both test ports must be terminated by a MATCH standard at the same time. When defined as a 1-port load standard, the loads are measured separately. The loads are assumed to have the same characteristics.
- The impedance of the MATCH standard becomes the reference impedance for the measurement. For best results, use the same load on both ports. The load may be defined using the data-based definition, the arbitrary impedance definition, or the fixed load definition.

E. Calibration Reference Z0

- System Z0: The system impedance is used as the reference impedance. Choose when the desired test port impedance differs from the impedance of the LINE standard. Also, choose when skin effect impedance correction is desired for coax lines.
- Line Z0: The impedance of the line standard is used as the reference impedance or center of the Smith Chart. Any reflection from the line standard is assumed to be part of the directivity error.

F. Test Port Reference Plane

- Thru Standard: The THRU standard definition is used to establish the measurement reference plane. Select if the THRU standard is zero-length or very short.
- Reflect Standard: The REFLECT standard definition is used to establish the position of the measurement reference plane. Select if the THRU standard is not appropriate AND the delay of the REFLECT standard is well defined.

7.5.6 Create a custom Cal Kit

There are two methods to create a custom Cal Kit:

Method 1: Create custom Cal Kit based on existing Cal kits

1. Press "Cal" > Cal > Cal Kit > F503ME > Save. Select the existing F503ME Cal Kit then save it to a local file named "F503ME123.xkt".

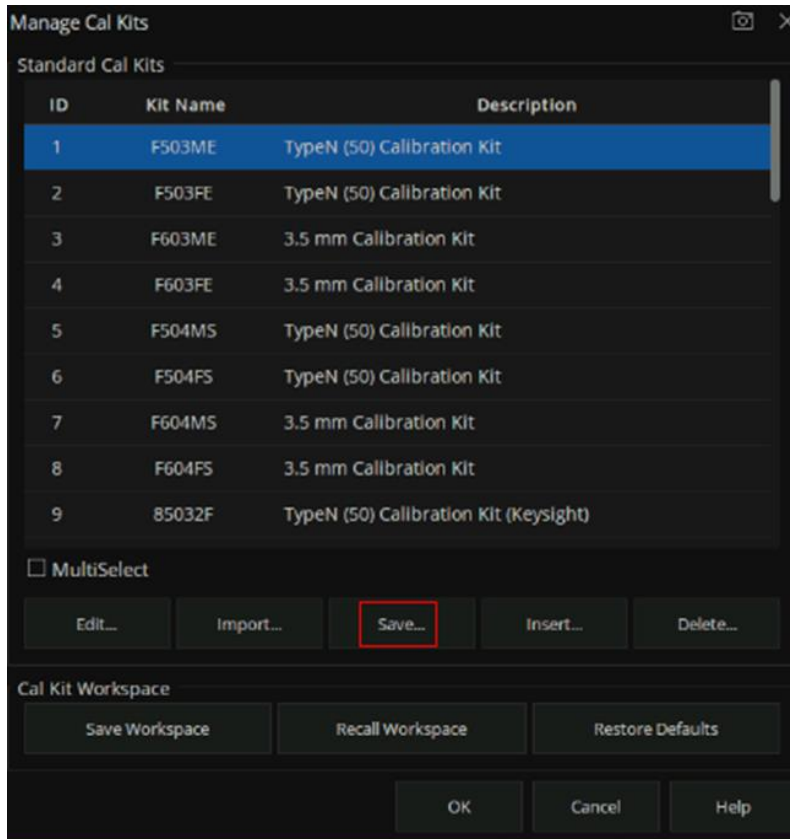

Figure 7-20 Creating a Custom Cal Kit dialog box

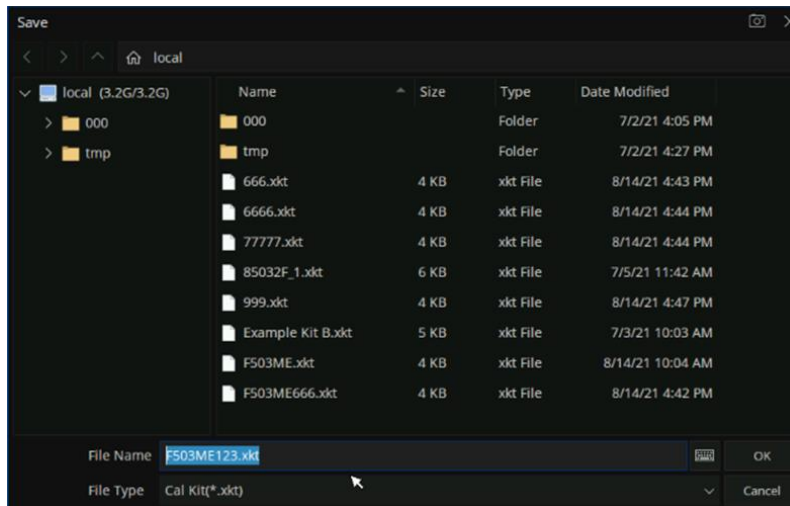

Figure 7-21 Save the Cal Kit

- In the Manage Cal Kits dialog box, click “Import” to Import the new calibration “F503ME123.xkt”.

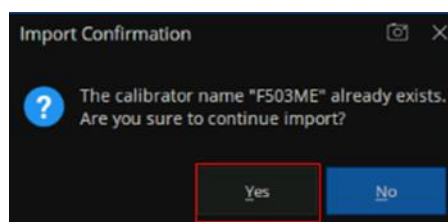
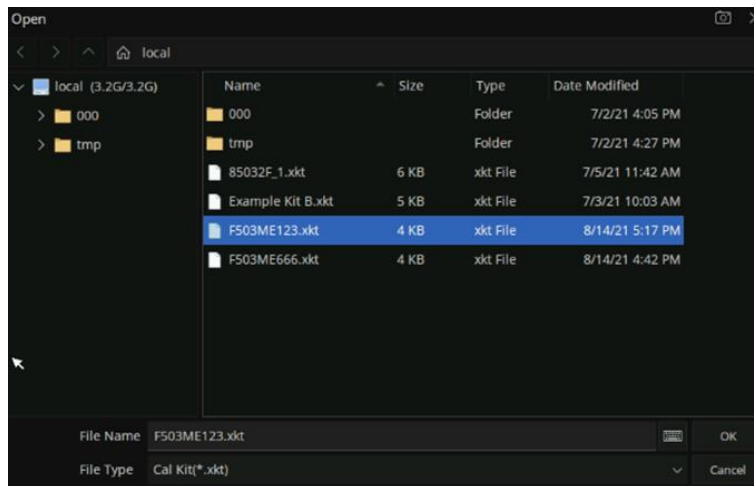

Figure 7-22 Import the new Cal Kit

3. Select the newly imported calibration, click "Edit" to enter the calibration editing interface, and modify the calibration name as "F530ME-ABC".

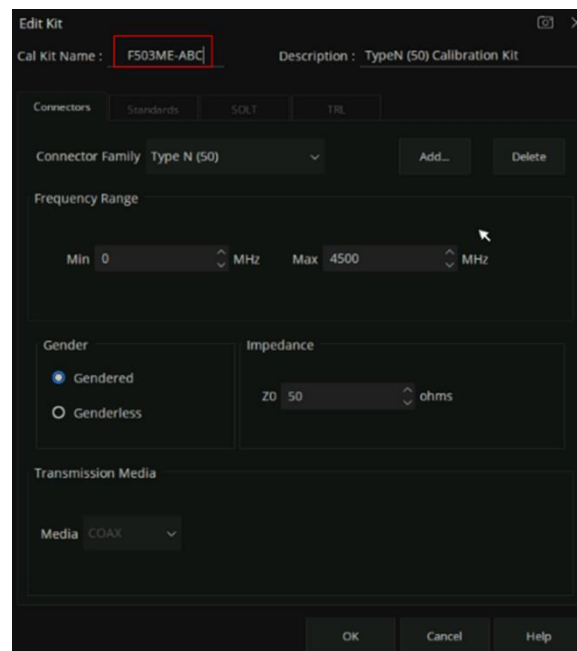

Figure 7-23 Edit the new import Cal Kit

4. Click the Connectors, Standards, SOLT, and TRL Tabs to modify the corresponding parameters as you need.
5. Click “OK” for the changed Cal Kit to take effect.

Method 2: Create a custom Cal Kit directly for new connector types.

1. Press “Cal” > Cal > Cal Kit > Insert...
2. Enter the name and description of the custom Cal Kit.
3. Refer to Method 1, click the Connectors, Standards, SOLT, TRL tab to modify the corresponding parameters.
4. Click “OK” to make the created calibration effective.

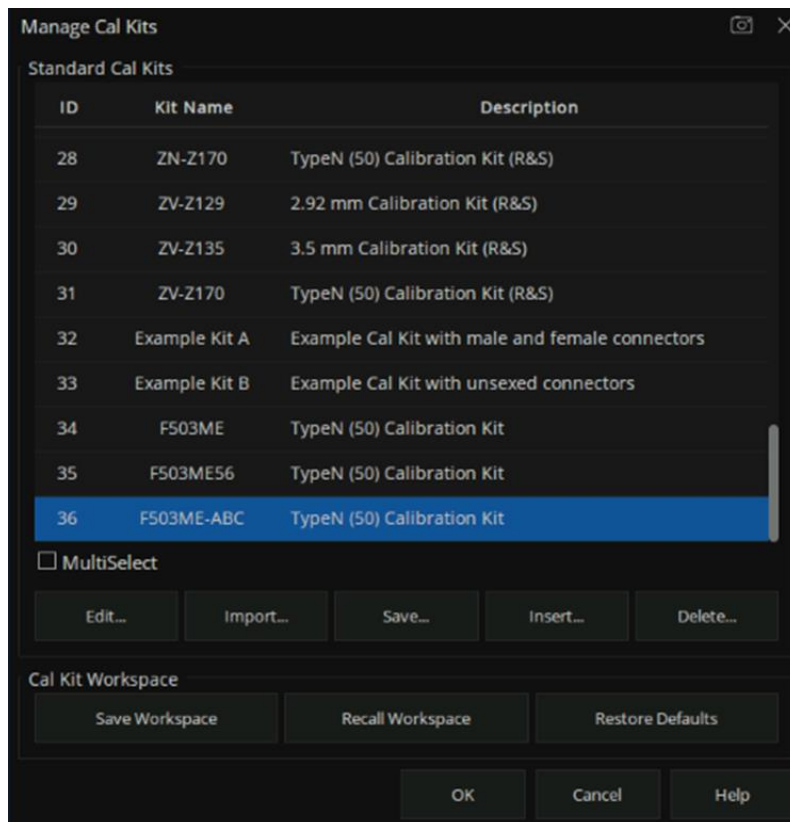

Figure 7-24 View the newly created Cal Kit

7.6 Power Cal

7.6.1 Internal source power calibration

The vector network analyzer has been calibrated for the output power of the transmitter before it leaves the factory, but the factory calibration may not guarantee sufficient accuracy in all cases. To improve the accuracy, the user can conduct an internal source power calibration before performing any tests.

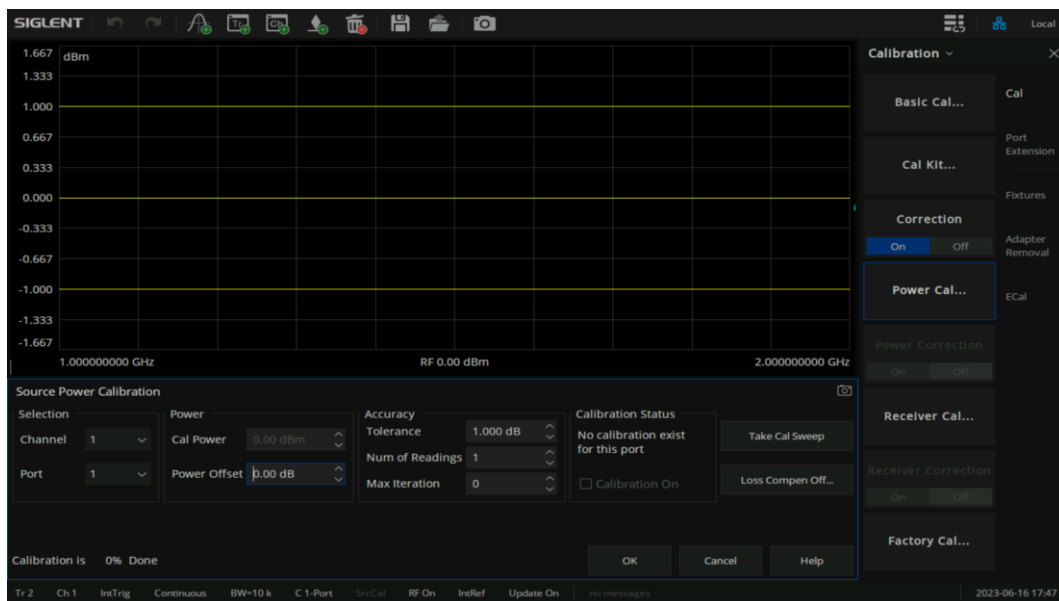

Figure 7-2 Transmitter power calibration

Before attempting power calibration, power loss compensation at different frequency points can be set as shown in the figure below. Click “+” successively to add corresponding frequency and loss values. After setting, click OK to save the data.

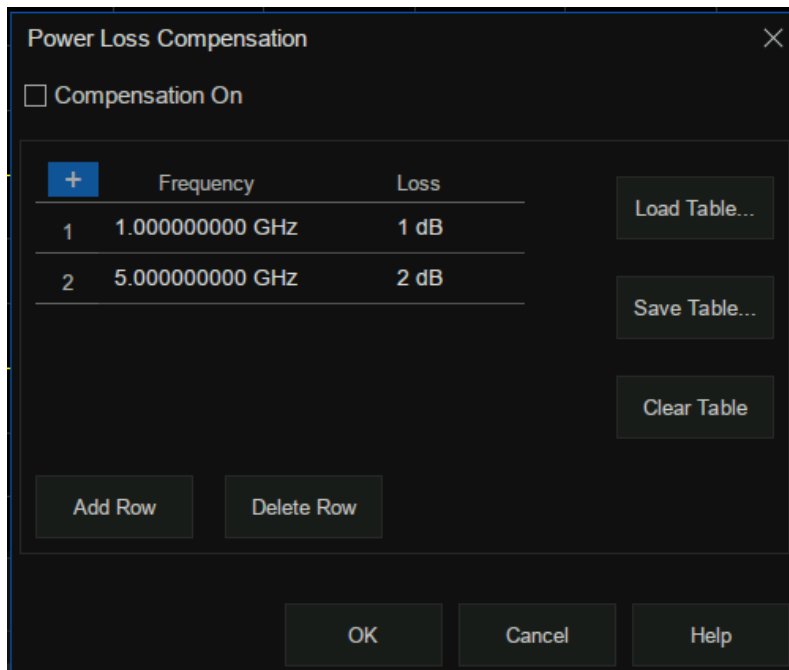

Figure 7-3 Set the interface

Power calibration operation steps:

1. Connect the port-under-test to a compatible power meter (Keysight U2000 series, R&S NRP series, etc.) and probe to ensure normal communication between the vector network analyzer and the power meter.
2. **Preset** vector network analyzer.
3. Set internal source output power, IF bandwidth, sweep points, test frequency band and other parameters.
4. Select **Cal** → **Power Cal** to enter the Settings screen.
5. Select the test channel and select the power output port.
6. Set parameters such as power offset, capacity limit, reading times, maximum iteration times, etc.
7. Click **Take Cal Sweep** to start the power output measurement.
8. Click **OK** to complete the calibration and exit the power calibration interface after the measurement is completed.

7.6.2 Receiver calibration

The vector network analyzer receiver power has been factory calibrated, but the factory calibration may not guarantee sufficient accuracy in every situation. The user can conduct a receiver power

calibration before the test to improve the test accuracy. To ensure the calibration accuracy of the receiver, it is better to calibrate the power of the internal source before the calibration of the receiver.

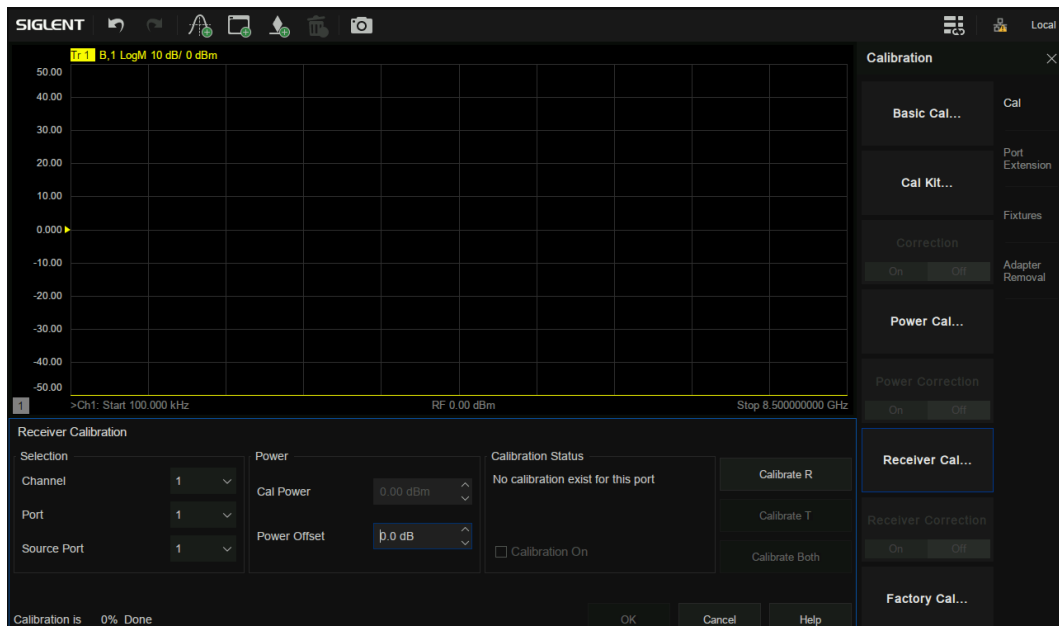

Figure 7-4 Receiver calibration setting interface

Operating steps:

1. **Preset** vector network analyzer.
2. Set internal source output power, IF bandwidth, sweep points, test frequency band, and other parameters.
3. Select **Cal** → **Receiver Cal** to enter the Settings screen.
4. Select the test channel, select the internal source output port, select the receiver port
5. Connect the two ports using an appropriate specification RF cable.
6. Set parameters such as power offset.
7. **Calibrate R** or **Calibrate T** or **Calibrate Both** can be clicked to begin receiver calibration.
8. Click **OK** to complete the calibration and exit the receiver calibration interface.

7.7 Port extension

Eliminating the errors of test fixturing can be a difficult task. The port extension function of a vector

network analyzer is a good method to eliminate the error of test fixtures. The calibration of S parameters is usually carried out by the user at the plane where the RF cable is connected to the test fixture, typically a connector (SMA, N-type, etc.). The actual device to be tested is located in the test fixture. The device to be tested and the test fixture are generally connected by a microstrip line. As a result, the actual measurement plane of the device to be tested does not coincide with the calibration reference plane (the connector, as mentioned previously) which will introduce calibration errors.

After the S parameter calibration is performed, the reference plane can be extended to the specified measurement plane by simply adding the added microstrip line length, speed factor, loss, and other parameters in the setting interface, to carry out more accurate testing.

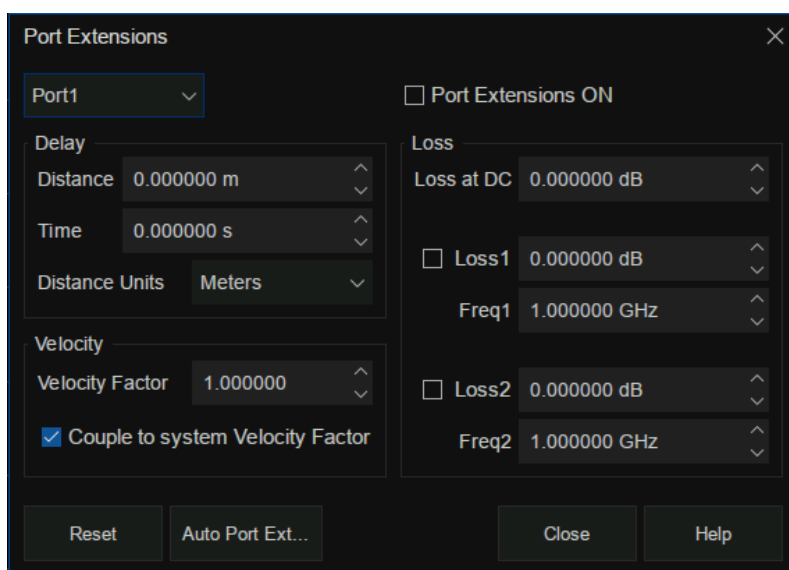

Figure 7-5 Port extension setting interface

7.7.1 Manual port extension

1. Perform the appropriate calibration type (SOLT, etc.) on the associated cabling before entering Port Extensions.
2. Select **Cal** → **Port Extension** → **Port Extension** to enter the Settings screen.
3. Select the port that needs to be extended, the unit of length, and input the velocity coefficient.

The velocity coefficient is different, and the propagation time of electromagnetic waves on the transmission line is different. Input the length of the extended transmission line and the time will be calculated automatically.

If the transmission line has loss, the loss of the transmission line can be added, including DC and AC loss.

The AC loss can be selected as LOSS1 at the single-frequency point or LOSS1 and LOSS2 at the dual-frequency point.

Among them, the fitting algorithm for two forms of AC loss are:

Single-frequency point loss Loss1:

$$\text{Loss}(f) = \text{Loss1} * (f/\text{Freq1}) ^ 0.5$$

Dual-frequency point loss Loss1, Loss2:

Set the low frequency point to LOSS1 and the high frequency point to LOSS2,

$$\text{Loss}(f) = \text{Loss1} * (f/\text{Freq1}) ^ n, n = \lg [\text{abs}(\text{Loss1}/\text{Loss2})] / \lg (\text{Freq1}/\text{Freq2}).$$

4. Select whether to coupling to the system speed factor. If unchecked, the speed factor is set only for the specified port, and when checked, for all ports.
5. Check the **Port Extensions ON** button and the Port extension will take effect.

Manual port extensions require the user to manually enter the parameters of the extended transmission line, while automatic port extension does not require prior knowledge of the transmission line parameters. The calibration plane can be automatically extended to the actual reference plane by simply performing an open or short circuit calibration on the actual reference plane of the DUT. The automatic port extension function is not available in the following cases:

1. The sweep type is set to power sweep.
2. The frequency offset is set to on.
3. Waveguide transmission line port extension.

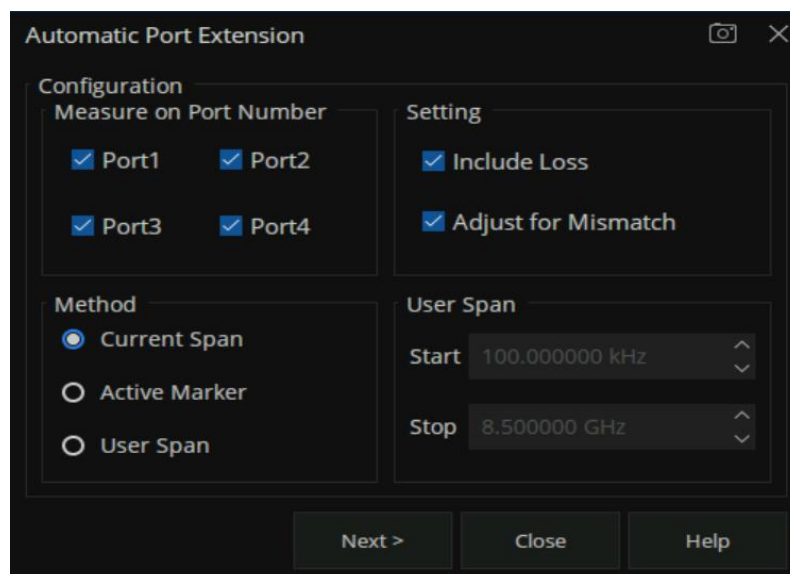

Figure 7-6 Automatic port extension setting interface

7.7.2 Automatic port extension

1. Perform the appropriate calibration type (SOLT, etc.) on the associated cabling before entering Port Extensions.
2. Select **Cal** → **Port Extension** → **Auto Port Extension** to enter the Settings screen.
3. Select the port you want to extend. Refer to practical application scenarios, select **Port 1** or **Port 2**, or both ports.
4. Select the frequency span of the test.

There are three frequency spans to choose:

Current Span: The frequency span of the current interface setting.

Active Marker: The frequency point currently marked, In this case, **Loss2** can be ignored when +setting loss, only **Loss1** can be set.

User Span: Use the start and end frequencies set by the user.

5. Set whether the loss should be included or not. Select this box to automatically measure the loss in the transmission line and apply it to the calibration.
6. The mismatch adjustment option is only available when the inclusion loss item is selected. The mismatch increases the ripple on the trace lines of S11 and S22. If the ripple is large, the trace display of S11 and S22 will be greater than 0 dB, resulting in unstable values when S parameters are used. Selecting the adjustment mismatch item can increase the loss of the fixture so that the peak value of the ripple is below 0 dB. Although this will increase the error, it can prevent the numerical instability of S parameters from appearing when it is used.
7. Click **Next** to enter the measurement interface. Before the measurement, make sure that the device has been removed from the test fixture. In this way, the open-circuit measurement can be performed. Of course, the test fixture can also refer to the plane Short circuit to conduct the Short measurement. It can carry out one of the Open or Short measurements or simultaneously carry out the Open and Short measurements. When two measurements are used, the result will be the average of the two measurements, and the accuracy will be improved

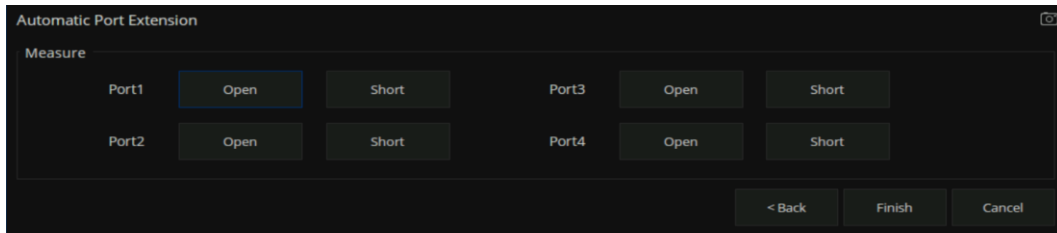

Figure 7-7 Automatic port extension calibration interface

7.8 Fixture measurement function

In addition to the port extension function, the vector network analyzer also provides several other functions for test fixtures:

1. Port match (2-port embedding)
2. Port impedance conversion
3. 2-port de-embedding
4. N port embed/ de-embed (port 4/6/8)
5. Differential port match
6. Differential port impedance conversion
7. Common port impedance conversion

7.8.1 Port match

1. Ensure that the user has completed the S parameter calibration.
2. Select **Cal** → **Fixtures** → **Fixture Setup** → **Port Match** to enter the Settings screen.
3. By selecting the port and the parameter representation form of the matching module, the S2P file (AKA Touchstone file) of the matching module can be directly exported or the circuit model of the matching module can be used. It supports 9 topologies which are combined by L, R, G, and C. It is necessary to manually set the parameter values of L, R, G, and C components. Checking the **Enable Port Matching On All Ports** tab means that all ports are matched. When the frequency range in the S2P file of the imported matching module is less than the frequency range set by the current interface, the system will extrapolate the S2P file by default. In other words, all the uncovered low-frequency parameters are replaced by the first point in the S2P file and all the uncovered high-frequency parameters are replaced by the last point in S2P file making the

frequency range of the S2P file the same as the frequency range of the current interface.

4. Click **Close** to complete the setting and click **Apply Fixtures** to ON to take effect.

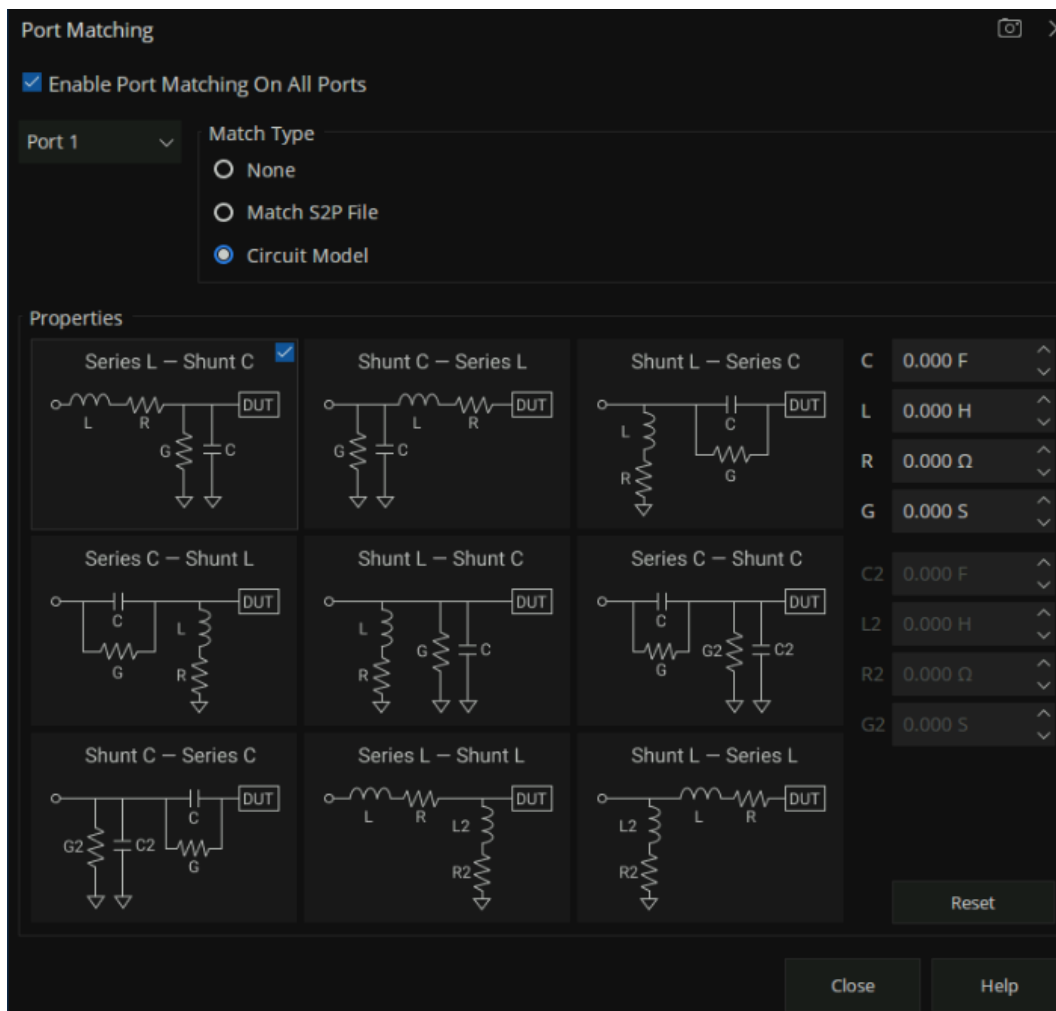

Figure 7-8 Port match

7.8.2 Port impedance conversion

1. Ensure that the user has completed the S parameter calibration.
2. Select **Cal** → **Fixtures** → **Fixture Setup** → **Port Z** to enter the Settings screen.
3. Choose the port, the default system port characteristic impedance is 50 Ω, you can fill in the required resistance values in the R and JX columns, Then the S parameter displayed will be automatically converted to the S parameter corresponding to the new characteristic impedance. Checking the **Enable Port Z Conversion On All Ports** tab means port matching is performed on all ports.

- Click **Close** to complete the setting and click **Apply Fixtures** to ON to take effect.

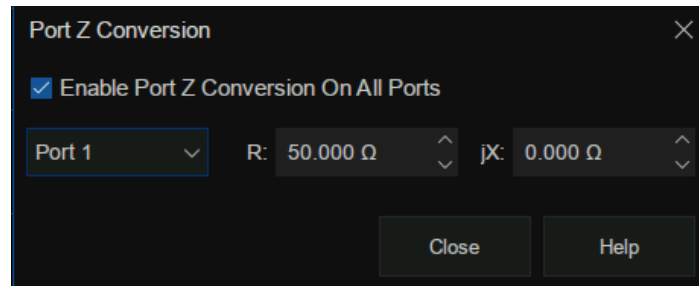

Figure 7-9-port impedance conversion

7.8.3 2-port de-embed

- Ensure that the user has completed the S parameter calibration.
- Select **Cal** → **Fixtures** → **Fixture Setup** → **2-Port DeEmbed** to enter the Settings screen.
- Select the port and select the form of de-embedding to import an S2P File. Click **User S2P File** to import the S parameter of the fixture part that needs to be removed.

Checking the **Enable De-Embedding On All Ports** tab means that all ports are de-embeddable.

When the frequency range in the S2P file of the imported matching module is smaller than the frequency range set by the current interface, the system will extrapolate the S2P file by default. All the low-frequency parameters not covered are replaced by the first point in the S2P file, and all the high-frequency parameters not covered are replaced by the last point in the S2P file, making the frequency range of the S2P file the same as that of the current interface.

- Checking the **Reverse Adapter Ports** entry represents the part of the reverse connection that will need to be de-embedding. By default, the system reverses the imported S2P file.
- Click **Close** to complete the setting and click **Apply Fixtures** to ON to take effect.

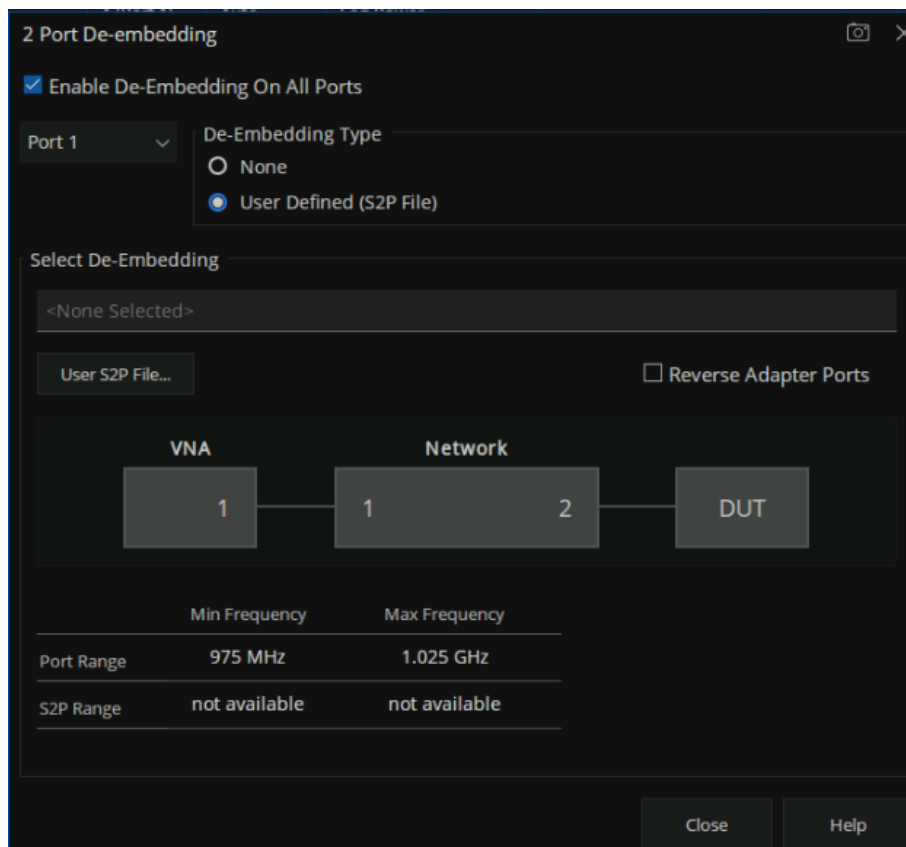

Figure 7-10 de-embedding interface

7.8.4 N-port embedding / de-embedding

1. Ensure that the user has completed the S parameter calibration.
2. Select **Cal** → **Fixtures** → **Fixture Setup** → **N-Port DeEmbed** to enter the Settings screen.
3. Select the topology type.

There are 3 topology types: A (using network 1); B (using network 1 and 3); C (using network 1, 2 and 4)

Select the port of the vector network analyzer in the VNA item, select the Network port configuration that needs to be embedded or de-embedded in the **Network**, and select the **Embed** operation or **De-embed** operation under each Network. Finally, load the S2P file corresponding to the operating network. Checking the **Enable 4/ 6/ 8-Port Embed / De-embed On All Ports** tab means that all ports are matched.

When the frequency range in the S2P file of the imported matching module is less than the frequency range set by the current interface, the system will extrapolate the S2P file by default.

In other words, all the uncovered low-frequency parameters are replaced by the first point in the

S2P file, and all the uncovered high-frequency parameters are replaced by the last point in the S2P file, making the frequency range of the S2P file the same as the frequency range of the current interface.

4. Click **Close** to complete the setting and click **Apply Fixtures** to ON to take effect.

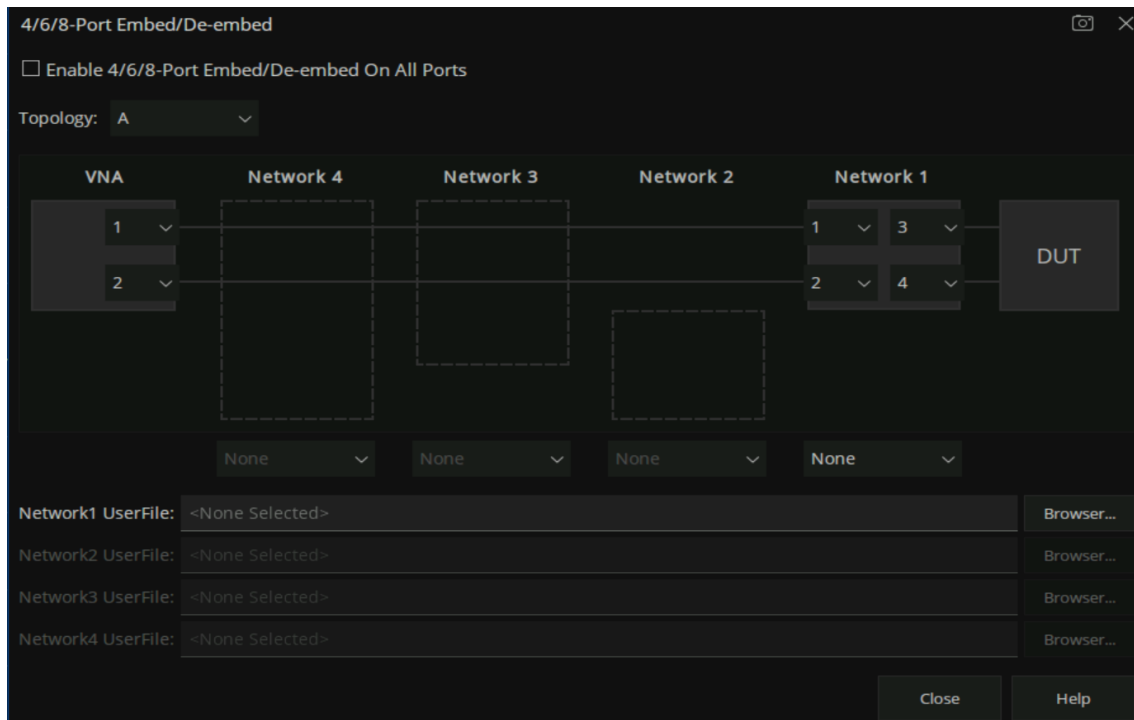

Figure 7-11 De-embedding interface

7.8.5 Differential port match

1. Ensure that the user has completed the S parameter calibration.
2. Select **Cal** → **Fixtures** → **Fixture Setup** → **Differential Port Match** to enter the Settings screen.
3. By selecting the port and the parameter representation form of the matching module, the S2P file of the matching module can be directly imported or the circuit model of the matching module can be used.

It is necessary to manually set the parameter values of L, R, G, and C components if the circuit model is used.

Checking the **Enable Differential Port Matching** tab means that all ports are matched.

When the frequency range in the S2P file of the imported matching module is less than the frequency range set by the current interface, the system will extrapolate the S2P file by default.

In other words, all the uncovered low-frequency parameters are replaced by the first point in the S2P file and all the uncovered high-frequency parameters are replaced by the last point in the S2P file making the frequency range of the S2P file the same as the frequency range of the current interface.

4. Click **Close** to complete the setting and click **Apply Fixtures** to ON to take effect.

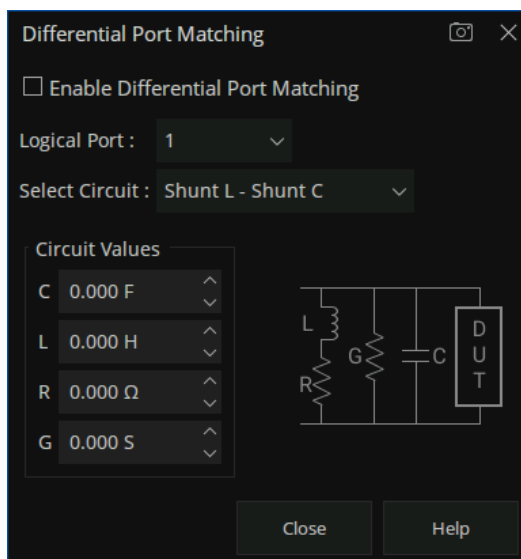

Figure 7-12 Differential port match

7.8.6 Differential and common port impedance conversion

The operation of differential port impedance conversion and common port impedance conversion is similar to that of port impedance conversion, please refer to the instructions of the latter.

7.9 Adapter removal / insertion function

Adapters are often used when the network analyzer is used to test the DUT. The vector network analyzer provides the function of removing and inserting adapters. Before the function of removing and inserting adapters is enabled, the vector network analyzer needs to carry out full 2-port calibration.

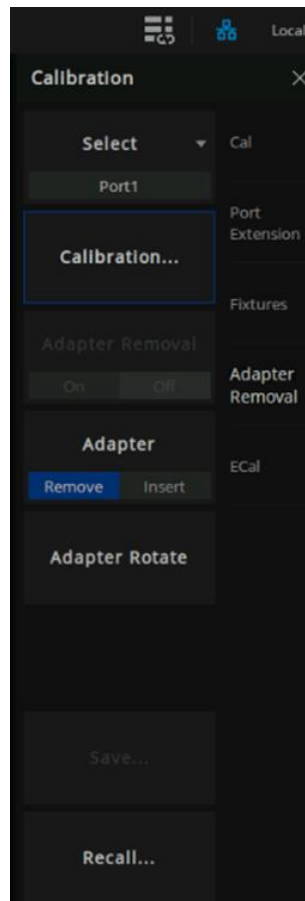

Figure 7-13 Adapter removal and insertion functions

7.9.1 Adapter removal

1. Connect the test cable of the vector network analyzer to the adapter, and configure the parameters of the network analyzer. First, perform the full 2-port calibration.
2. Select **Cal** → **Adapter Removal** to go to the Settings screen and select **Remove** in the **Adapter** tab.
3. Remove the adaptor from the test cable, Select **Cal** → **Adapter Removal** → **Calibration** to enter the **Adapter Removal** configuration screen. Select the port connected to the adaptor to be removed, select the calibration kit type, and select the polarity of the calibration kit. Click **Next** to connect the Open, Short and Load calibration elements in turn for full 1 port calibration.
4. Click **Finish** to complete the calibration and click Adapter Removal to ON to complete the Adapter Removal operation.

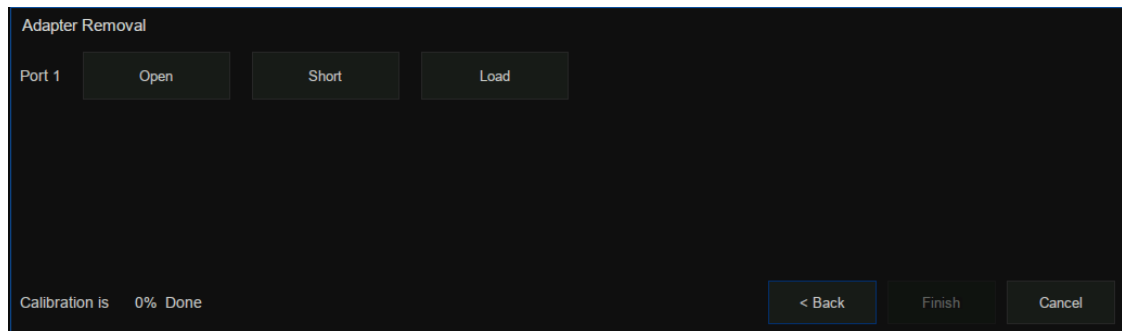

Figure 7-14 Adapter removal and insertion function calibration interface

7.9.2 Adapter insertion

1. Remove any test cables from the ports of the analyzer and perform a full 2-port calibration.
2. Select **Cal** → **Adapter Removal** to go to the Settings screen and select **Insert** in the **Adapter** tab.
3. Connect the adapter on the test cable, select **Cal** → **Adapter Removal** → **Calibration** to enter the **Adapter Removal** configuration screen. Select the port connected with the adaptor to be inserted, select the calibration kit model, select the polarity of the calibration kit, and click **Next** to connect the Open, Short, and Load calibration elements in turn for full 1 port calibration.
4. Click **Finish** to complete the calibration and click **Adapter Removal** to ON to complete the Adapter insertion operation.

“Adapter Rotate” is also known as the “equal exchange adapter and equal length adapter” calibration method. Before the unknown pass-through method was introduced, the switching adapter method was often used as a faster alternative to the more tedious adapter removal method.

7.10 ECal

7.10.1 ECal Overview

ECal is a new automatic calibration technology for vector network analyzers. Every ECal module contains electronic standards that are automatically switched into position during a measurement calibration. These electronic standards have been measured at the factory and the data stored within the memory of the ECal module. The analyzer uses this stored data, along with the measured data, to calculate the error terms for a measurement calibration. ECal offers the following advantages:

- The calibration process is simple. The electronic calibrator only needs to be connected to the

VNA once to complete the test items required by the dual-port calibration, without the need for multiple calibration connections.

- A shorter time is required for calibration.
- There are fewer uncertain factors in the calibration process, and the probability of electronic calibration being affected by misoperation is reduced because there is no need for multiple connection processes.

Use ECal to perform calibration

1. Connect the USB port on the ECal module with the USB port on the front panel of VNA via a USB cable. the module indicates "READY". When you connect the module, the type of module, frequency range, and connector type are automatically recognized.
2. Connect a port on the ECal module to the test port to be calibrated.
3. Press Cal > ECal on the front panel to enter the ECal menu interface.

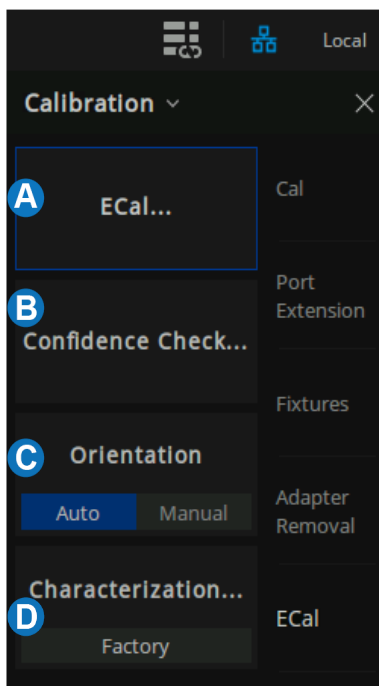

Figure 7-15 ECal menu

- A. ECal Config. Select the number of ports to calibrate. Then select the port number configuration.
- B. Confidence Check. Check the validity of Ecal calibration.
- C. Orientation. Select "Auto" (the default setting) the VNA automatically senses the model and direction in which an ECal module port is connected to the VNA ports. Select "Manual" to manually set the specified port.
- D. Characterization. View the characterization information stored in the ECal module

7.10.2 ECal Config

Press "Cal" on the front panel , Press Cal > ECal > ECal to enter the menu interface of ECal setting.



Figure 7-16 ECal config menu

- A. Select the number of ports to calibrate and configure the port number. Using ECal, you can perform 1-Port Reflection calibration, Full 2-Port calibration, Full 3-Port calibration, and Full 4-Port calibration.
- B. Select the Cal Type
- C. When “Orientation” is Auto, click “Next” to enter the automatic alignment directly. When “Orientation” is Manual, click “Next” to specify the calibration port and go to auto-calibration.

7.10.3 Confidence Check

1. Press “Cal” on the front panel, press Cal > ECal > Confidence Check to enter the menu interface of Confidence Check.

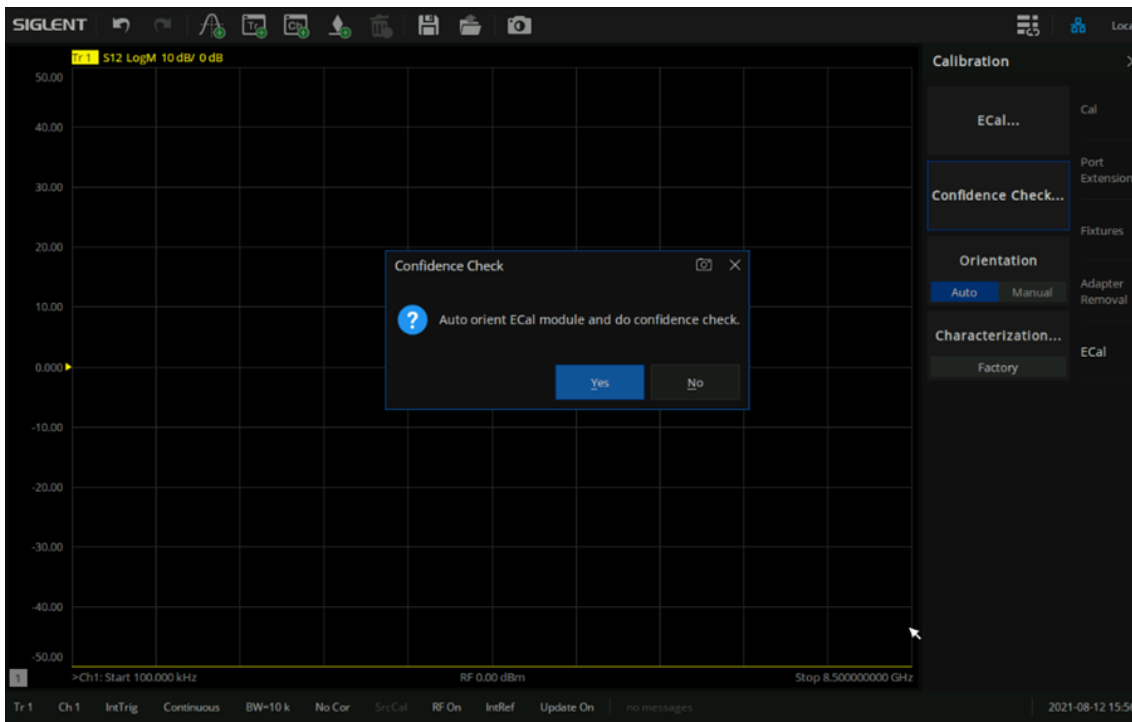

Figure 7-17 Confidence Check

2. Compare the data-trace with the memory trace and verify that the measurement is correct.
3. The steps to compare when both data and memory traces are displayed are as below:
 - Press "Math" on the front panel, Press "Math" > Memory > Math > Data + Memory.
 - Press "Scale" on the front panel, Press "Scale" > Scale > Auto Scale.
 - Determine if the differences between trace lines are acceptable.

7.10.4 Orientation

The ECal module automatically detects the connection between SNA's test ports and ECal module's ports. You can turn off this function to set ports manually.

Manual port setting procedure for Full 2-Port calibration

1. Press "Cal" on the front panel, Press "Cal" > ECal > Orientation > Manual.
2. Specify a test port of the VNA.
3. Specify an ECal port for the port of the VNA you specified.

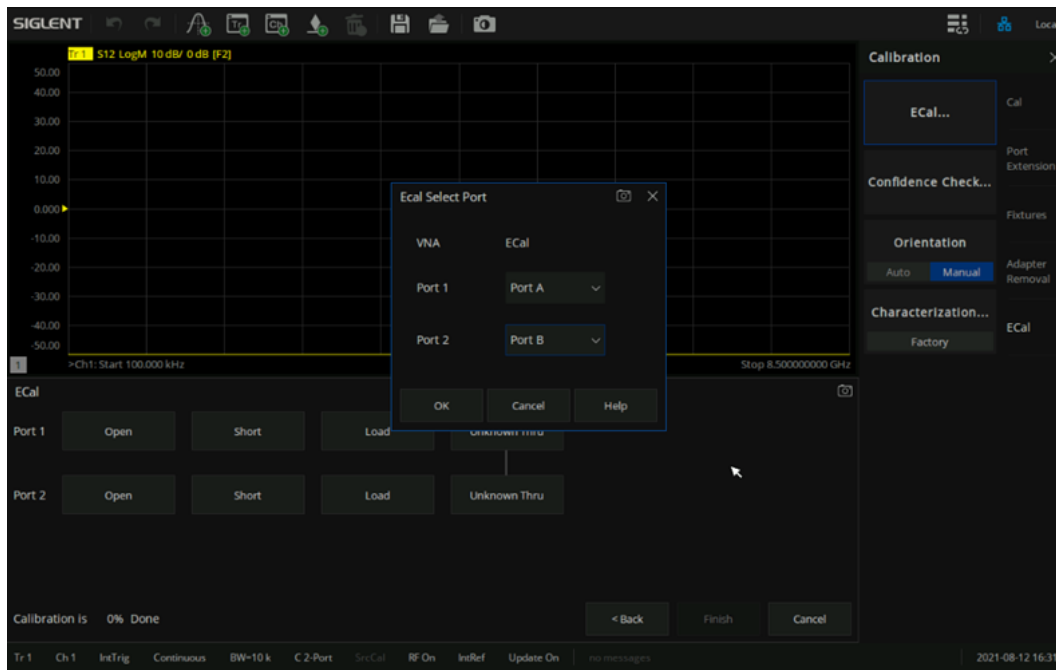

Figure 7-18 Manual port setting

7.10.5 Characterization

Press “Cal” on the front panel, press “Cal” > Cal > Characterization > Factory to view all the parameters of the stored Characterization in the ECal module.

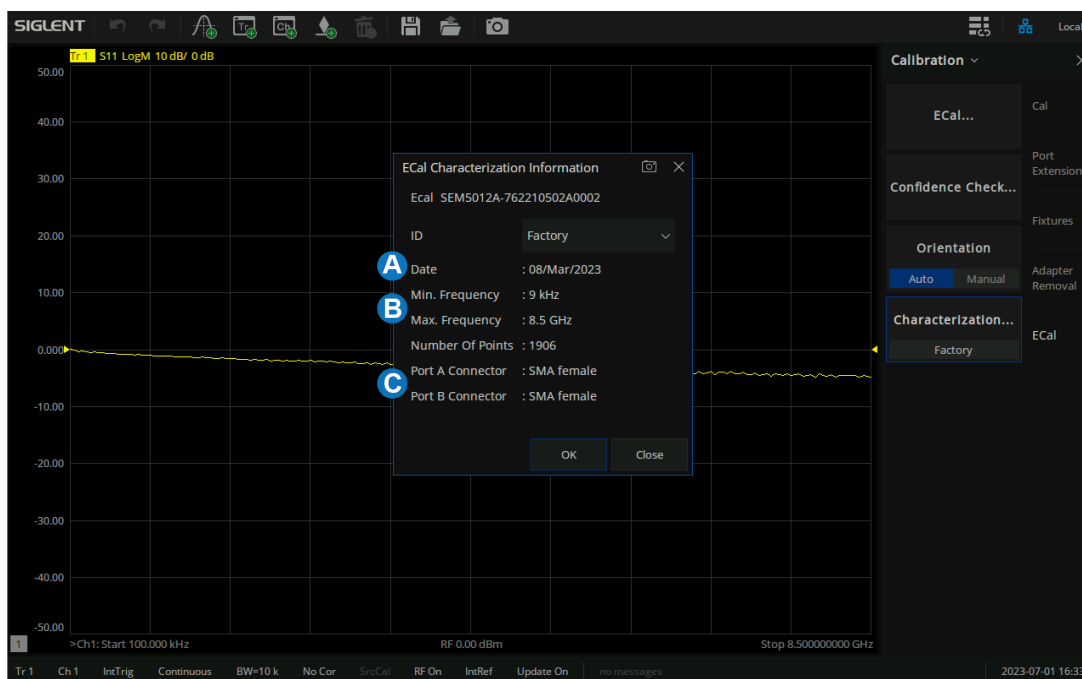

Figure 7-19 The factory information of Cal Kit

- A. The date when the characteristics were measured
- B. The stimulus conditions when the characteristics were measured
- C. The information of the Connector type

8 Data Analysis

8.1 Marker

The marker can display defined measurement data of traces. Each trace can set nine ordinary markers and one reference marker.

8.1.1 Ordinary marker:

Press the **Marker** button on the front panel, click **Add Marker** in the **Marker** submenu to create a marker, then set the required test frequency. If there are many markers on the trace, click **Select** to select the desired marker. After the marker is created, the measurement value of the marker will be displayed at the top right of the window, and the value format is the same as the format of the trace. We can click the **Delete Marker** command under the marker submenu to delete the marker and select the marker to delete from the pop-up menu. When a trace is deleted, all markers on the trace will be deleted. Click the **All Off** command under the **Marker** submenu or the **Marker Setup** submenu to delete all markers on the current trace.

8.1.2 Reference marker:

Press the **Marker** button on the front panel, click **Reference Marker** in the **Marker** submenu, make the **On** option selected then the **Reference Marker** will be created. By default, the **Reference Marker** is created at the location of the current ordinary **Marker**. If there is no ordinary **Marker** on the current trace, the **Reference Marker** will be created at the center of the trace. **Reference Markers** are denoted by an R. After creating a **Reference Marker**, set the **Reference Marker** as value discretization, fixed marker, and coupling, we can set the data format of **Reference Marker's** display value and view the **Reference Marker's** value in the marker table, but the **Reference Marker** cannot be set as a difference (delta) marker. Click **Reference Marker** in the **Marker** submenu, select the **Off** option to delete the **Reference Marker**.

8.1.3 Marker setting:

Press the **Marker** button on the front panel, set the current marker in the **Marker Setup** submenu, we can make the following settings for the currently selected marker:

1. **Difference (delta) display:**

The difference display mode is closed by default, to open the difference display mode, click the **Delta** to select the **On** option, then the marker's value will display the difference between the ordinary marker and the reference marker, and the marker's value is marked with " Δ ". If a reference marker has not been added to the trace, the reference marker will be automatically set on the trace. To display the absolute value of the marker, click the **Delta** again to select the **Off** option.

2. Value discretization:

The value discretization mode is closed by default. Due to the limited number of sampling points set on the trace, the data of other points except the sampling points are based on the interpolation value of the sampling point data, which is approximate to the actual data, not the real measured data. By setting the value discretization of the marker, the value of the marker can only be taken at the sampling point, which ensures that the marker's value is from the measurement data and not interpolated data. To open the value discretization mode, click the **Discrete** to select the **On** option, at this time, the data of the marker is only selected from the sampling points, when the coordinate value of the marker is not in the sampling point, the marker is automatically moved to the nearest sampling point. To turn off the value discretization, click the **Discrete** to select the **Off** option.

3. Fixed marker:

The fixed marker mode is closed by default. Fixed markers have a fixed excitation position (x-axis coordinate), its response value (Y-axis coordinate) will change according to the trace data update. To keep the fixed value of the marker unchanged, click the **Type** command to select the **Fixed** option, then the marker's value will keep the current value unchanged, and the marker does not move up or down with the trace update. To restore the marker real-time update, click the **Type** command again to select the **Normal** option.

4. Data format:

The newly created marker uses the current trace's data format by default. To change the data format of the marker, click the **Format** and select the corresponding data format in the pop-up menu. The following data formats are available:

Trace Default	Lin Magnitude
Log/Phase	Phase
Lin/Phase	SWR
Re/Im	Delay
R+jx	Real
G+jB	Imaginary
Log Magnitude	

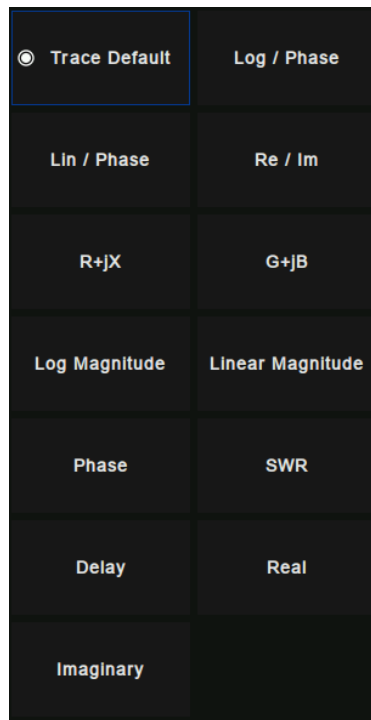

Figure 8-1 Data format interface

5. Marker coupling:

The newly created marker turns off coupling by default. At this time, the marker is only set on a single trace, and the markers on different traces do not affect each other. If we need multiple markers on different traces to share settings, we can use the marker coupling function. Click the **Coupled** command, and select the range of the marker coupling in the pop-up menu for coupling operation. When the marker coupling mode is on, the markers of the same number and X-axis (such as frequency or time) on all traces in the coupling range share the settings, and the marker's setting on the current trace will be used by default. If the current marker is not in the coupling range, the marker with the same number on the trace with the smallest trace number is used.

Note: when the marker coupling mode is on, the marker on the trace within the coupling range will automatically move to the same X-axis coordinate.

6. Marker table:

The newly created marker closes the marker table by default. If we need to display all marker data in the form of a table, we can use the marker table function. Click the **Marker Table** to select the **On** state, a table will appear at the bottom left to display all marker's values, click the **Marker Table** again to select the **Off** option to close the marker table.

8.1.4 Marker Display

Press the **Marker** button on the front panel, set the display effect for the current cursor in the **Marker Display** submenu:

- **Show Readout:** The system is turned on by default. If this switch is turned off, the cursor reading will be hidden.
- **Active Trc Only:** The system is turned off by default. If this switch is turned on, only the cursor reading of the current working trace will be displayed.
- **Align:** The system is turned on by default. If this switch is turned off, the cursor of different traces will not be aligned and displayed.
- **X Pos:** Set the display position of the cursor reading on the X-axis.
- **Y Pos:** Set the display position of the cursor reading on the Y-axis.
- **Decimal Places:** By default, the Auto Decimal Places check box is checked. When unchecked, the decimal places for the stimulus value and response value of the cursor reading can be set.

8.1.5 Marker function

Press the **Marker** button on the front panel, use the current marker to set the excitation in the **Marker Function** submenu. Use the currently selected marker to achieve the following functions:

- **Marker** → **Start:** Set the current marker position (X coordinate) as the sweeping starting point.
- **Marker** → **Stop:** Set the current marker position (X coordinate) as the sweeping ending point.
- **Marker** → **Center:** Set the current marker position (X coordinate) as the sweeping center point. Note: When using this command, the sweeping boundary value far from the current marker will be changed to reduce the sweeping range, so that the marker position becomes the new sweeping center point.
- **Marker** → **Span:** This function is only available when the current marker is a difference (delta) marker. Set the sweeping range between the current marker position and the reference marker position (x coordinate).
- **Marker** → **Ref Level:** Set the response value (Y coordinate) of the current marker to the reference level of the current trace.
- **Marker** → **Delay:** Referring to the phase slope of the current marker position, the line length is adjusted to the receiver input, this function helps to smooth the phase trace around the current

marker. For the equipment without constant group delay in the measurement frequency span, another electrical delay adjustment is needed. This function can be used to measure electrical length or deviation from a linear phase. This function requires the measured phase difference, so it is only suitable for proportional measurements.

- **Marker** → **CW Freq**: Set the current marker position (frequency) to continuous wave (CW) frequency. This function requires the x-axis field of the current marker, otherwise, it is invalid. After changing CW frequency with this command, enable power or CW sweeping to apply the changed CW frequency setting.
- **Marker** → **SA**: If the current mode is SA, the center frequency is set to the current marker value; If it is not SA mode, then switch to SA mode, set the center frequency to the current marker value, and set span to 10 times of the previous step freq.

8.2 Marker search function

The marker can be used to search the maximum value, minimum value, peak value, and target value of the trace in the specified search domain. It can also search for multi-peak value, multi-target, bandwidth filtering, and band-stop filtering.

8.2.1 Search domain

The search domain is the frequency span included in a marker search operation. Each marker has an independent search domain, and the default is full span, which is the same as the current sweep range. The X coordinate movement range of the marker is limited in its search domain. The user can set up to 16 custom search domains. The search domains are independent of each other and allowed to overlap. The search field can be set for each marker, and multiple markers are allowed to share one search domain.

To set a custom search domain, press the **Search** button on the front panel, click the **Domain** command in the **Search** submenu, and click the **Add** command in the pop-up menu. Then click the **Domain** command again, click and select the newly created custom search domain in the pop-up menu, and enter the required values in the **Start** and **Stop** text boxes below the domain command. When the search domain of the current marker is not full span, the indicator "Δ" will appear on the x-axis to identify the search domain of the current marker. To delete a user-defined search domain, click the **Domain** command, select the search domain to be deleted in the pop-up menu, then click the **Domain** command again, and then click **Delete** in the pop-up menu. If the search domain of the marker is deleted, its search domain is automatically set to full span.

8.2.2 Max and min search

Press the **Search** button on the front panel and click the **Max Search** command in the **Search** submenu to move the current marker to the maximum response value in the search domain. Press the **Search** button on the front panel and click the **Max Search** command in the **Search** submenu to move the current marker to the maximum response value in the search domain. Click the **Min Search** command to move the current marker to the minimum response value in the search domain.

8.2.3 Peak search

Press the **Search** button on the front panel to search the peak in the **Peak** submenu. Before searching for the peak value, the effective peak value to be searched should be defined first. The validity of the peak value is determined by the search domain, peak polarity, threshold, and deviation:

Peak polarity: According to the polarity, the peaks are divided into two categories: Positive and negative. The positive peak value refers to situations where the measured value is greater than the measured value at both ends of a span, and the negative peak value refers to the peak value that the measured value is less than the measured value at both ends of a span. Click the **Peak Polarity** command in the **Peak** submenu to select the peak polarity. The **Both** option means that both positive and negative peaks are regarded as valid peaks for the search.

Threshold: For the positive peak, only the peak whose measured value is greater than the threshold is considered valid; for the negative peak, only the peak whose measured value is less than the threshold is considered valid; when the polarity of the peak is set to **Both**, the threshold is not used as the basis for judging the validity of the peak. To set the threshold, click the **Threshold** command in the **Peak** submenu to enter the required value.

Deviation: The deviation value of peak value refers to the smaller difference between the measured value of peak value and the measured value of an adjacent peak with the opposite polarity. Only the peak value with a deviation greater than the rated value is considered valid. To set the deviation value, click the **Excursion** command in the **Peak** submenu to enter the required value.

After determining the effective peak range and search domain, the peak search can be started. There are several peak searching modes available:

- Using the **Peak Search** command in the **Peak** submenu, the peak with the largest measured value among the effective positive peaks or the peak with the smallest measured value among the effective negative peaks will be included in the search according to the peak polarity setting. If the current peak polarity is set to **Both**, the peak with the largest measured value among the effective positive peaks is searched.
- Use the **Peak Right** → **Search** command in the **Peak** submenu to search the nearest effective peak from the current marker position to the right.
- Use the **Peak Left** ← **Search** command in the **Peak** submenu to search the nearest effective peak from the current marker position to the left.
- Use the **Next Peak Search** command in the **Peak** submenu to search for the effective positive peak value next lower than the current marker measurement value or the effective negative peak value next higher than the current marker measurement value according to the peak polarity setting. If the current peak polarity is set to **Both**, the effective peak next lower than the current vernier measurement value is searched.

8.2.4 Target search

Press the **Search** button on the front panel to search the target in the **Target** submenu. Before searching the target, set the target value and transition type:

Target value: The target value refers to the response value to search (Y coordinate). If the response value of a point on the trace is equal to the target value, then the point is the target point to search. To set the target value, click the **Target Value** command in the **Target** submenu to enter the required value.

Transition type: The target points are divided into two types, positive and negative. The positive target conversion type means that the measured value on the right side of the target point is greater than that on the left side, while the negative target conversion type means that the measured value on the right side of the target point is less than that on the left side. Click the **Transition** command in the **Target** submenu to select the conversion type to search for. The **Both** option means that both positive and negative target conversion types are regarded as valid targets.

After the target value, transition type and search domain are determined, the target search can be started. The vector network analyzer has the following target search modes:

- Use the **Target Search** command in the **Target** submenu to search for the nearest effective

target from the current marker position to the right. When no effective target can be found from the right, search from the starting point of the search domain to the right.

- Use the **Target Right** → **Search** command in the target submenu to search the nearest valid target from the current marker position to the right.
- Use the **Target Left** ← **Search** command in the **Target** submenu to search the nearest valid target from the current marker position to the left.

8.2.5 Multi-peak search

Press the **Search** button on the front panel to search for multiple peaks in the **Multi Peak & Target** submenu. Before searching for multiple peaks, you need to set the threshold, deviation, and peak polarity in the **Peak Threshold**, **Peak Excursion** and **Peak Polarity** commands in the submenu to define the peak validity. After setting the above parameters, click the **Multi Peak Search** command to search all effective peaks from the starting point of the search domain to the right, and mark the peaks with a marker. Since there can only be 9 common markers on a single trace, only the first 9 effective peaks can be found when there are many effective peaks.

8.2.6 Multi-target search

Press the **Search** button on the front panel to search for multiple targets in the **Multi Peak & Target** submenu. Before multi-target search, you need to set the target value and conversion type in the **Target Value** and **Transition** submenu to define the target validity. After setting the above parameters, click the **Multi-Target Search** command to search all valid targets from the starting point of the search domain to the right, and mark the searched targets with a marker. Since there can only be 9 common markers on a single trace, only the first 9 valid targets can be found when there are many valid targets.

8.2.7 Tracking search

When using the above search function, the marker position is only based on the current sweeping result, and will not be dynamically updated with the trace update after the search. Tracking mode can be used to update search results with trace data. Press the **Search** button on the front panel, click the **Tracking** command, and select the search type in the pop-up menu; the search in the tracking mode uses the search parameter settings in the above search.

8.2.8 Bandwidth search

The bandwidth search is a function for determining the bandwidth of the trace, center frequency, cut-off points (on the higher frequency and the lower frequency sides), Q and insertion loss based on the position of the active marker or peak marker.

Press the **Search** button on the front panel to search the bandwidth in the **Bandwidth** submenu. Click **BW Search Enable** and select the **On** option to search the bandwidth. After the bandwidth search is completed, a small triangle will be used to mark the cut-off frequency of the trace, and the bandwidth, center frequency, cut-off frequency, quality factor, and insertion loss will be displayed in the upper right corner of the window. To turn off the bandwidth search, click **BW Search Enable** again and select the **Off** option. You can set whether to alarm when the bandwidth search fails in the **Sound On Fail** command.

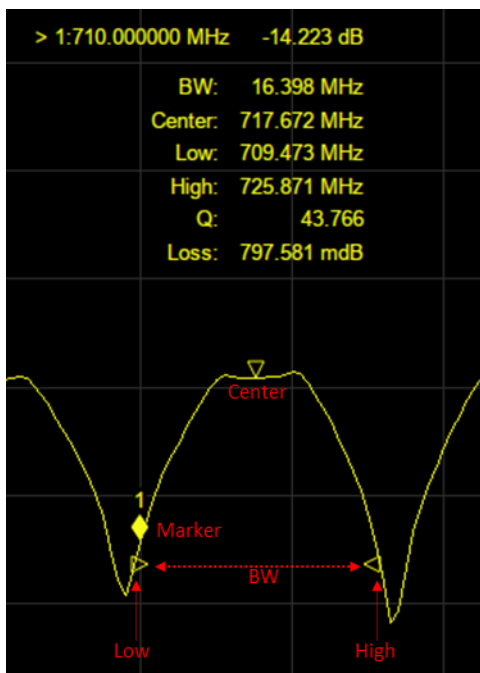

Figure 8-2 Bandwidth search example

8.2.9 Notch search

The notch search function is used to obtain the bandwidth, center frequency, cutoff points (high-frequency side and low-frequency side), Q and insertion loss of a trace based on the active marker or peak marker position. The notch search function starts from the left side of the active marker position and ends when points that meet the conditions are found.

Press the **Search** button on the front panel to search the band stop in the **Notch** submenu. Click the **Notch Search Enable** command and select the **On** option to perform the band stop search. After the band stop search is completed, a small triangle will be used to mark the cut-off frequency of the trace, and the bandwidth, center frequency, cut-off frequency, quality factor, and insertion loss will be displayed in the upper right corner of the window. To turn off the band stop search, click the **Notch Search Enable** command again and select the **Off** option. You can set whether to alarm when the band stop search fails in the **Sound On Fail** command.

The following values are displayed for Bandwidth and Notch Search:

- **Bandwidth (BW):** The difference in frequency between the higher frequency cut-off and lower frequency cut-off points (High - Low).
- **Center frequency (Center):** Frequency at the middle point between the lower frequency cut-off and higher frequency cut-off points. $(\text{High} + \text{Low})/2$.
- **Lower frequency cut-off point (Low):** Lower frequency of 2 measurement points, both separated by the defined bandwidth / notch value from the active marker position.
- **Higher frequency cut-off point (High):** Higher frequency of 2 measurement points, both separated by the defined bandwidth / notch value from the active marker position.
- **Q:** Ratio of Center Frequency to Bandwidth (Center Frequency / Bandwidth).
- **Insertion loss (loss):** The measured value of the position of the center frequency at the time the bandwidth/notch search is executed.

8.3 Mathematical operation

The vector network analyzer supports saving the current data-trace in memory. It can perform four kinds of mathematical operations on the current data-trace and memory trace. In addition, it can calculate and display statistical data (mean, standard deviation, and peak-peak) on the data-trace. In addition, through the built-in formula editor, you can use multiple types of traces from the same or different channels to build custom formulas. When the mathematical operation with memory trace needs to be carried out, the current data needs to be stored in memory first. Click **Data** → **Memory** to complete the storage operation. In the **Display** menu bar, you can select three display modes: Display data-trace only, display memory trace and display data-trace and memory trace at the same time. The four mathematical operations of data-trace and memory trace are as follows, in which the values on data-trace and memory trace are linear:

- **Data/Memory:** Divide the measured data by the data in the stored trace. This function can be used to calculate the ratio of two traces (such as calculating gain or attenuation), which can also be

regarded as the normalization operation of test data.

- **Data*Memory:** The current measurement data is multiplied by the data in memory.
- **Data+Memory:** Current measurement data plus data in memory.
- **Data–Memory:** Current measurement data minus data in memory. For example, you can use this function to store measured data, the error is then subtracted from the DUT measurement.

8.4 Conversion

The vector network analyzer supports parameter conversion, which can convert the S parameter of the current trace to the required parameter mode. The vector network analyzer supports the following 8 conversion types.

- Z-Reflect: Impedance in reflection measurement Z_r .

$$Z_r = Z_{0a} \times \frac{1 + S_{aa}}{1 - S_{aa}}$$

- Z-Transmit: Impedance in transmission measurement Z_t .

$$Z_t = \frac{2 \times \sqrt{Z_{0a} \times Z_{0b}}}{S_{ab}} - (Z_{0a} + Z_{0b})$$

- Z-Trans-Shunt: Impedance in parallel transmission Z_t .

$$Z_t = \frac{1}{Y_t}$$

- Y-Reflect: Reflection measurement admittance Y_r .

$$Y_r = \frac{1}{Z_r}$$

- Y -Transmit: Admittance in transmission measurement Y_t .

$$Y_t = \frac{1}{Z_t}$$

- Y -Trans-Shunt: Admittance in parallel transmission Y_t .

$$Y_{01} = \frac{1}{Z_{01}}$$

$$Y_{02} = \frac{1}{Z_{02}}$$

$$Y_t = \frac{2 \times \sqrt{Y_{01} \times Y_{02}}}{S_{ab}} - (Y_{01} + Y_{02})$$

- 1/S: Reciprocal of S parameter.
- Conjugation: Convert the measured value to a complex conjugate number.

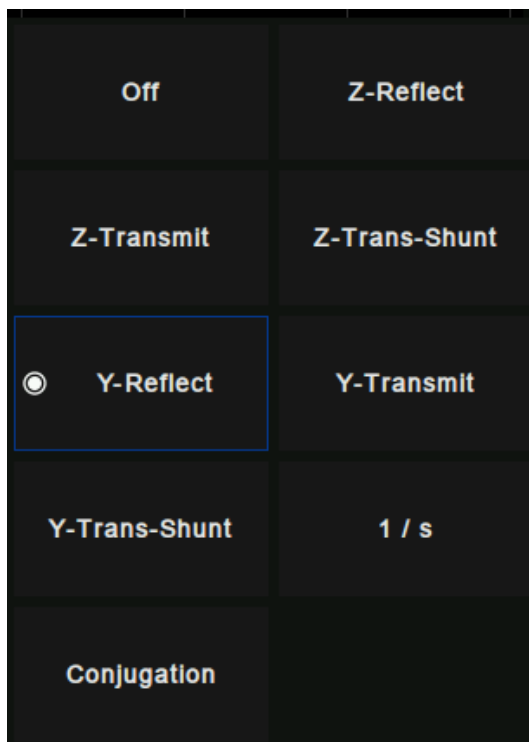

Figure 8-3 Parameter conversion type

When both the fixture simulation measurement function and the port impedance function are in the “on” state, the system will use the value set in the port impedance conversion. In other cases, the system Z_0 (preset value: 50Ω) will be used. The operation steps for selecting the conversion type are as follows:

1. Click **Math** → **Analysis** → **Conversion** enter the selection interface.
2. Select the corresponding conversion type, effective immediately.

8.5 Equation editor

In the equation editor, we can input the algebraic formulas of standard mathematical operators and functions, and reference the data available in the vector network analyzer. After a valid formula is entered and enabled, the working trace will be displayed as the result of the set formula and updated in real-time.

For example, enter the formula $S_{21}/(1 - S_{11})$. The trace is calculated by dividing each S_{21} data point by 1 and subtracting the value of the corresponding S_{11} data point. For a 201 points sweep, the calculation is repeated 201 times, once per point. In addition, suppose that the vector network analyzer is required to measure the directivity of a 3-port device to be tested, and the directivity is not the

measurement parameter of the vector network analyzer, then the formula editor can be used to complete the measurement, and the result is the sum and difference of the traces in logarithmic amplitude format, that is $S_{12} + S_{23} - S_{13}$. Because the formula editor operates on linear complex data, the actual required formula is $S_{12} * S_{23} / S_{13}$

Finally, the vertical axis format is set to logarithmic amplitude for display. The operation steps of the equation editor are as follows:

1. Click **Math** → **Analysis** → **Equation Editor** enter the equation editor interface.

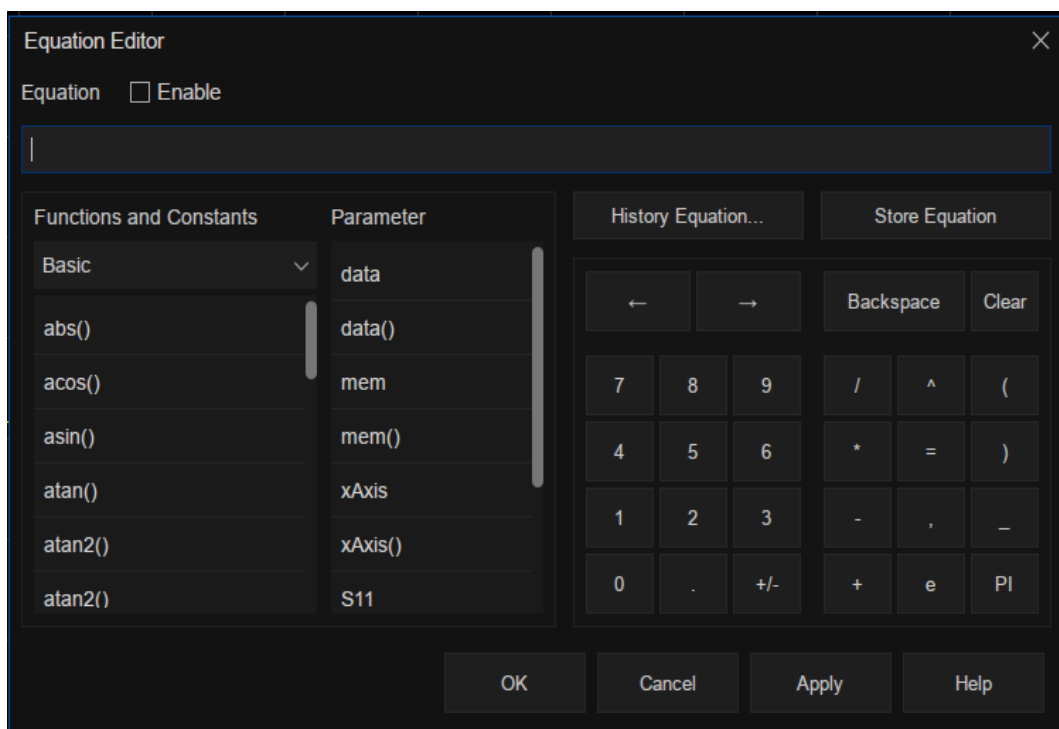

Figure 8-4 Formula editor interface

2. In the formula edit box, enter functions, operators, and data to form the formula.
3. After setting the formula, click OK to exit the formula editing interface and click the **Equation** status to On to take effect.

Introduction to formula editor interface:

- **Enable:** Select the box to enable the currently entered formula, and clear the box to disable the currently edited formula. If the data traces used are from other channels instead of formula traces, these channels must have the same number of data points to be valid channels.
- **Functions and Constants:** It stores some commonly used functions and constants, as well as

other functions set by the system.

- **Parameter:** Select the items that need to be measured only from the working channel.
- **History Equation:** Used to save previously-stored formulas.
- **Store Equation:** Store the current input formula to facilitate subsequent use.
- ←: Move the cursor to the left without clearing the characters.
- →: Move the cursor to the right without clearing the character.
- **Backspace:** Clear the character while moving the marker to the left.
- **Clear:** Clear the currently entered formula.
- **Numbers, operators, and constants:** Numbers, common operators, and constants.

Description of functions and constants in formula editor:

Common functions	Description
Abs (complex a)	Returns the $\sqrt{a.re*a.re+a.im*a.im}$
Acos (scalar a)	Returns the arc cosine of a in radians
Asin (scalar a)	Returns the arc sine of a in radians
Atan (scalar a)	Returns the arc tangent of a in radians
atan2 (complex a)	Returns the phase of a = (re, im) in radians
atan2 (scalar a, scalar b)	Returns the phase of (a, b) in radians
Conj (complex a)	Returns the conjugate of a
Cos (complex a)	Takes a in radians and returns the cosine
Cpx (scalar a, scalar b)	Returns a complex value (a+ib) from two scalar values
Exp (complex a)	Returns the exponential of a
Im (complex a)	Returns the imaginary part of a as the scalar part of the result (zeroes the imaginary part)
Ln (complex a)	Returns the natural logarithm of a
log10 (complex a)	Returns the base 10 logarithm of a
Mag (complex a)	Returns $\sqrt{a.re*a.re+a.im*a.im}$
Phase (complex a)	Returns atan2(a) in degrees
Pow (complex a, complex b)	Returns a to the power b
Re (complex a)	Returns the scalar part of a (zeroes the imaginary part)
Sin (complex a)	Takes a in radians and returns the sine

Sqrt (complex a)	Returns the square root of a, with phase angle in the half-open interval $(-\pi/2, \pi/2]$
Tan (complex a)	Takes a in radians and returns the tangent

Constant	
e	2.71828182845904523536
PI	3.14159265358979323846

Advanced function	Description
A (complex a, complex b, complex c, complex d)	F11 conversion = $((1+a)^*(1-d) + b*c)/(2*b)$
A (scalar i, scalar j)	returns A(Sii, Sji, Sij, Sjj)
B (complex a, complex b, complex c, complex d)	F12 conversion = $Z0*((1+a)^*(1+d) - b*c)/(2*b)$
B (scalar i, scalar j)	returns B(Sii, Sji, Sij, Sjj)
C (complex a, complex b, complex c, complex d)	F21 conversion = $(1/Z0)*((1-a)^*(1-d)-b*c)/(2*b)$
C (scalar i, scalar j)	returns C(Sii, Sji, Sij, Sjj)
D (complex a, complex b, complex c, complex d)	F22 conversion = $((1-a)^*(1+d) + b*c)/(2*b)$
D (scalar i, scalar j)	returns D(Sii, Sji, Sij, Sjj)
H11 (complex a, complex b, complex c, complex d)	H11 conversion = $Z0*((1+a)^*(1+d) - b*c)/((1-a)^*(1+d) + b*c)$
H11 (scalar i, scalar j)	returns H11(Sii, Sji, Sij, Sjj)
H12 (complex a, complex b, complex c, complex d)	H12 conversion = $2*c/((1-a)^*(1+d) + b*c)$
H12 (scalar i, scalar j)	returns H12(Sii, Sji, Sij, Sjj)
H21 (complex a, complex b, complex c, complex d)	H21 conversion = $-2*b/((1-a)^*(1+d) + b*c)$
H21 (scalar i, scalar j)	returns H21(Sii, Sji, Sij, Sjj)
H22 (complex a, complex b, complex c, complex d)	H22 conversion = $(1/Z0)*((1-a)^*(1-d) - b*c)/((1-a)^*(1+d) + b*c)$
H22 (scalar i, scalar j)	returns H22(Sii, Sji, Sij, Sjj)
Kfac (complex a, complex b, complex c, complex d)	k-factor = $(1 - \text{abs}(a)^2 - \text{abs}(d)^2 + (\text{abs}(a*d - b*c)^2))/(2*\text{abs}(b*c))$
Kfac (scalar i, scalar j)	returns kfac(Sii, Sji, Sij, Sjj)

MAPG (complex a, complex b, complex c, complex d)	maximum available power gain = $\text{abs}(b/c) * (\text{kfac}(a,b,c,d) - \sqrt{(\text{kfac}(a,b,c,d))^2 - 1})$
MAPG (scalar i, scalar j)	Returns MAPG(Sii, Sji, Sij, Sjj)
MSG (complex a, complex b, complex c, complex d)	maximum stable power gain = $\text{abs}(b)/\text{abs}(c)$
MSG (scalar i, scalar j)	Returns MSG(Sii, Sji, Sij, Sjj)
mu1 (complex a, complex b, complex c, complex d)	$\mu\text{-factor} = (1 - \text{abs}(a)^2) / (\text{abs}(d - \text{conj}(a) * (a*d - b*c)) + \text{abs}(b*c))$
mu1 (scalar i, scalar j)	Returns mu1(Sii, Sji, Sij, Sjj)
mu2 (complex a, complex b, complex c, complex d)	$\mu\text{-factor} = (1 - \text{abs}(d)^2) / (\text{abs}(a - \text{conj}(d) * (a*d - b*c)) + \text{abs}(b*c))$
mu2 (scalar i, scalar j)	Returns mu2(Sii, Sji, Sij, Sjj)
T11 (complex a, complex b, complex c, complex d)	T11 conversion = $-(a*d - b*c)/b$
T11 (scalar i, scalar j)	Returns T11(Sii, Sji, Sij, Sjj)
T12 (complex a, complex b, complex c, complex d)	T12 conversion = a/b
T12 (scalar i, scalar j)	Returns T12(Sii, Sji, Sij, Sjj)
T21 (complex a, complex b, complex c, complex d)	T21 conversion = $-d/b$
T21 (scalar i, scalar j)	Returns T21(Sii, Sji, Sij, Sjj)
T22 (complex a, complex b, complex c, complex d)	T22 conversion = $1/b$
T22 (scalar i, scalar j)	Returns T22(Sii, Sji, Sij, Sjj)
Y11 (complex a, complex b, complex c, complex d)	Y11 conversion = $(1/Z0) * ((1-a) * (1+d) + b*c) / ((1+a) * (1+d) - b*c)$
Y11 (scalar i, scalar j)	Returns Y11(Sii, Sji, Sij, Sjj)
Y12 (complex a, complex b, complex c, complex d)	Y12 conversion = $(1/Z0) * (-2*c) / ((1+a) * (1+d) - b*c)$
Y12 (scalar i, scalar j)	Returns Y12(Sii, Sji, Sij, Sjj)
Y21 (complex a, complex b, complex c, complex d)	Y21 conversion = $(1/Z0) * (-2*b) / ((1+a) * (1+d) - b*c)$
Y21 (scalar i, scalar j)	Returns Y21(Sii, Sji, Sij, Sjj)
Y22 (complex a, complex b, complex c, complex d)	Y22 conversion = $(1/Z0) * ((1+a) * (1-d) + b*c) / ((1+a) * (1+d) - b*c)$

Y22 (scalar i, scalar j)	Returns Y22(Sii, Sji, Sij, Sjj)
Z11 (complex a, complex b, complex c, complex d)	Z11 conversion = $Z0*((1+a)*(1-d) + b*c)/((1-a)*(1-d) - b*c)$
Z11 (scalar i, scalar j)	Returns Z11(Sii, Sji, Sij, Sjj)
Z12 (complex a, complex b, complex c, complex d)	Z12 conversion = $Z0*(2*c)/((1-a)*(1-d) - b*c)$
Z12 (scalar i, scalar j)	Returns Z12(Sii, Sji, Sij, Sjj)
Z21 (complex a, complex b, complex c, complex d)	Z21 conversion = $Z0*(2*b)/((1-a)*(1-d) - b*c)$
Z21 (scalar i, scalar j)	Returns Z21(Sii, Sji, Sij, Sjj)
Z22 (complex a, complex b, complex c, complex d)	Z22 conversion = $Z0*((1-a)*(1+d) + b*c)/((1-a)*(1-d) - b*c)$
Z22 (scalar i, scalar j)	Returns Z22(Sii, Sji, Sij, Sjj)

Channel parameter data	
data	Corrected data
data(scalar i)	Corrected data of trace i (trace number)
mem	Memory data
mem(scalar i)	Memory data of trace i (trace number)
xAxis	X-axis data
xAxis(scalar i)	X-axis data of trace i (trace number)
S11 - S44	S-parameter data

Common H parameter, Y parameter, Z parameter, F parameter, and T parameter definition (2-port network):

- 1) Mixing Parameter(H)

$$\begin{pmatrix} V_1 \\ I_2 \end{pmatrix} = (H) \begin{pmatrix} I_1 \\ V_2 \end{pmatrix} \quad (H) = \begin{pmatrix} H_{11} & H_{12} \\ H_{21} & H_{22} \end{pmatrix}$$

- 2) Admittance parameter(Y)

$$\begin{pmatrix} I_1 \\ I_2 \end{pmatrix} = (Y) \begin{pmatrix} V_1 \\ V_2 \end{pmatrix} \quad (Y) = \begin{pmatrix} Y_{11} & Y_{12} \\ Y_{21} & Y_{22} \end{pmatrix}$$

3) Impedance parameter(Z)

$$\begin{pmatrix} V_1 \\ V_2 \end{pmatrix} = (Z) \begin{pmatrix} I_1 \\ I_2 \end{pmatrix} \quad (Z) = \begin{pmatrix} Z_{11} & Z_{12} \\ Z_{21} & Z_{22} \end{pmatrix}$$

4) Basic parameter(F)

$$\begin{pmatrix} V_1 \\ I_2 \end{pmatrix} = (F) \begin{pmatrix} V_2 \\ -I_1 \end{pmatrix} \quad (F) = \begin{pmatrix} A & B \\ C & D \end{pmatrix}$$

5) Scattering transmission parameter(T)

$$\begin{pmatrix} a_1 \\ b_1 \end{pmatrix} = (T) \begin{pmatrix} b_2 \\ a_2 \end{pmatrix} \quad (T) = \begin{pmatrix} T_{11} & T_{12} \\ T_{21} & T_{22} \end{pmatrix}$$

$$a_1 = \frac{V_1 + I_1 Z_0}{2 \cdot \sqrt{Z_0}} \quad a_2 = \frac{V_2 + I_2 Z_0}{2 \cdot \sqrt{Z_0}}$$

$$b_1 = \frac{V_1 - I_1 Z_0}{2 \cdot \sqrt{Z_0}} \quad b_2 = \frac{V_2 - I_2 Z_0}{2 \cdot \sqrt{Z_0}}$$

S parameter convert to H parameter, Y parameter, Z parameter, F parameter and T parameter (2-port network):

1) S parameter convert to H parameter

$$H_{11} = Z_0 \cdot \frac{(1 + S_{11})(1 + S_{22}) - S_{12}S_{21}}{(1 - S_{11})(1 + S_{22}) + S_{12}S_{21}}$$

$$H_{12} = \frac{2 \cdot S_{12}}{(1 - S_{11})(1 + S_{22}) + S_{12}S_{21}}$$

$$H_{21} = \frac{-2 \cdot S_{21}}{(1 - S_{11})(1 + S_{22}) + S_{12}S_{21}}$$

$$H_{22} = \frac{1}{Z_0} \cdot \frac{(1 - S_{11})(1 - S_{22}) - S_{12}S_{21}}{(1 - S_{11})(1 + S_{22}) + S_{12}S_{21}}$$

2) S parameter convert to Y parameter

$$Y_{11} = \frac{1}{Z_0} \cdot \frac{(1 - S_{11})(1 + S_{22}) + S_{12}S_{21}}{(1 + S_{11})(1 + S_{22}) - S_{12}S_{21}}$$

$$Y_{12} = \frac{1}{Z_0} \cdot \frac{-2 \cdot S_{12}}{(1 + S_{11})(1 + S_{22}) - S_{12}S_{21}}$$

$$Y_{21} = \frac{1}{Z_0} \cdot \frac{-2 \cdot S_{21}}{(1 + S_{11})(1 + S_{22}) - S_{12}S_{21}}$$

$$Y_{22} = \frac{1}{Z_0} \cdot \frac{(1 + S_{11})(1 - S_{22}) + S_{12}S_{21}}{(1 + S_{11})(1 + S_{22}) - S_{12}S_{21}}$$

3) S parameter convert to Z parameter

$$Z_{11} = Z_0 \cdot \frac{(1 + S_{11})(1 - S_{22}) + S_{12}S_{21}}{(1 - S_{11})(1 - S_{22}) - S_{12}S_{21}}$$

$$Z_{12} = Z_0 \cdot \frac{2 \cdot S_{12}}{(1 - S_{11})(1 - S_{22}) - S_{12}S_{21}}$$

$$Z_{21} = Z_0 \cdot \frac{2 \cdot S_{21}}{(1 - S_{11})(1 - S_{22}) - S_{12}S_{21}}$$

$$Z_{22} = Z_0 \cdot \frac{(1 - S_{11})(1 + S_{22}) + S_{12}S_{21}}{(1 - S_{11})(1 - S_{22}) - S_{12}S_{21}}$$

4) S parameter convert to basic parameter

$$A = \frac{(1 + S_{11})(1 - S_{22}) + S_{12}S_{21}}{2 \cdot S_{21}}$$

$$B = Z_0 \cdot \frac{(1 + S_{11})(1 + S_{22}) - S_{12}S_{21}}{2 \cdot S_{21}}$$

$$C = \frac{1}{Z_0} \cdot \frac{(1 - S_{11})(1 - S_{22}) - S_{12}S_{21}}{2 \cdot S_{21}}$$

$$D = \frac{(1 - S_{11})(1 + S_{22}) + S_{12}S_{21}}{2 \cdot S_{21}}$$

5) S parameter convert to T parameter

$$D_s = S_{11}S_{22} - S_{12}S_{21}$$

$$T_{11} = \frac{-D_s}{S_{21}}$$

$$T_{12} = \frac{S_{11}}{S_{21}}$$

$$T_{21} = \frac{-S_{22}}{S_{21}}$$

$$T_{22} = \frac{1}{S_{21}}$$

Description of formula editor's operator:

Operator	Description	Operator	Description
+	plus	(opening parenthesis
-	minus)	closing parenthesis
*	multiply	,	comma, parameter separator
/	divide	=	equal
^	power	E	exponent

Note: operator priority:

1. ^
2. *, /
3. +, -

8.6 Trace statistics

Click **Math** → **Analysis** → **Statistics**, set the status to On to open the statistics function. The upper right corner of the interface will display the mean value, standard deviation, and peak to peak value of the current working trace.

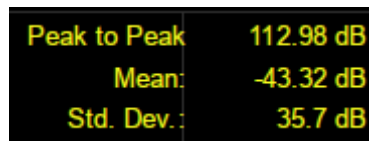

Peak to Peak	112.98 dB
Mean:	-43.32 dB
Std. Dev.:	35.7 dB

Figure 8-5 Statistical data interface

8.7 Limit test

Limit Line is a test form that can visualize test data and results. The limit test compares the measured data with the defined limit and provides the qualified or unqualified judgment information of each measured data point. Limit line and limit test are not suitable for smith chart and polar coordinate display formats, and limit line and limit test functions are automatically disabled for these display types.

Limit table setting

Click **Math** → **Analysis** → **Limit** and the pop-up dialog box is shown in the figure below. Limit test, sound type, limit table, global pass/fail can be set in this interface.

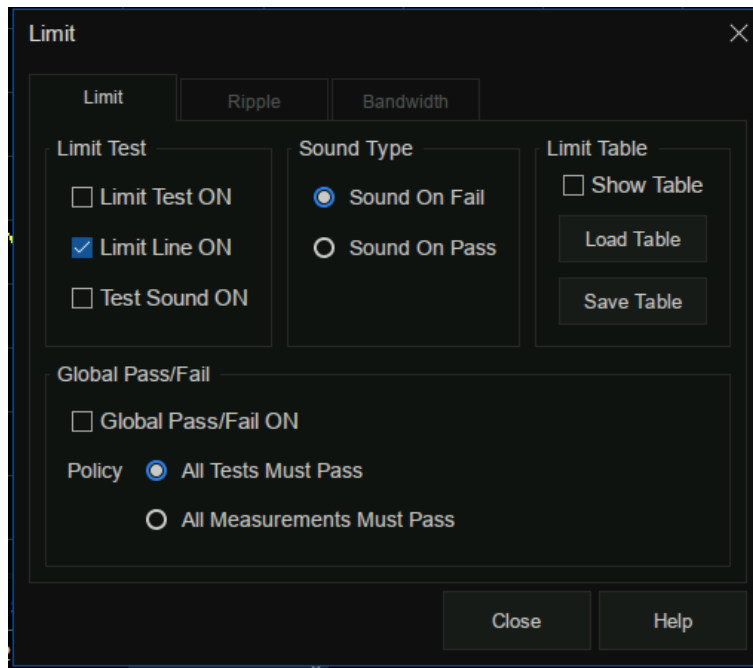

Figure 8-6 Limit test interface

Limit test:

- Limit test on: Check this box to compare the data with the limit and display “pass” or “Fail” judgment result.
- Limit line on: Check this box to display the limit on the screen.
- Sound on fail: When this box is selected, when the point on the trace fails in the limit test, a beep will sound.

Sound type:

- Sound on fail: When this box is checked, the equipment will beep when the test fails.
- Sound on pass: When this box is checked, the equipment will beep when the test passes.

Limit table:

- Show table: Check this box to open a table at the bottom of the screen to create and edit limits.
- Load table: Call the saved limit table, the saved format of the limit table is CSV by default.

Global pass / fail:

Pass / fail indicator is a convenient way to monitor all measurement status.

Global pass / fail on - Check this box to display the global pass / fail status.

Policy - Select which of the following requirements must be met for the global pass/fail status to display “pass”:

- **All tests must pass** - This setting will read the results from the limit test. If all tests (limit test is on) pass, the global pass/fail status will be “pass”.
- **All measurements must pass** - Unless all measured data points are within the established test limits and the limit test is “on”, the global pass/fail status will be “fail”.

Note: In this mode, if there is a test that does not set the limit test to the on state, the global pass / fail will display “fail”.

Limit line setting

Click **Math** → **Analysis** → **Limit Table** → **Limit** to open the limit line setting interface, we can also click **Math** → **Analysis** → **Limit** → **Show Table** to open the limit line setting interface, as shown in the figure below.

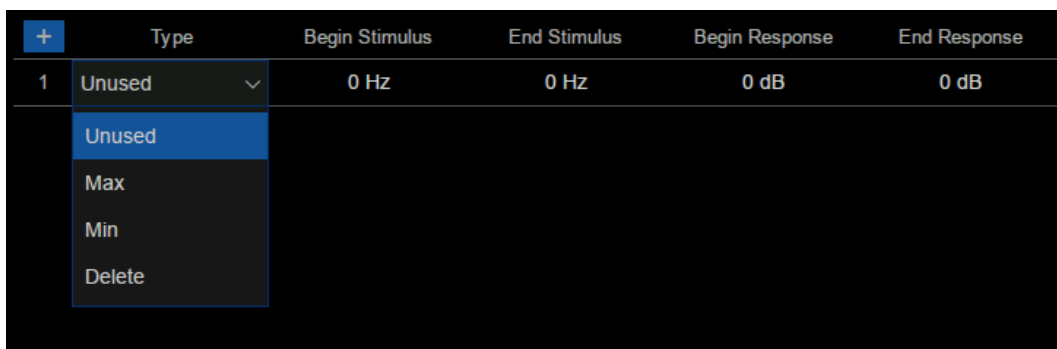

	Type	Begin Stimulus	End Stimulus	Begin Response	End Response
1	Unused	0 Hz	0 Hz	0 dB	0 dB

Figure 8-7 Limit line setting interface

Limit line type:

- Unused: Invalid limit line.
- Max: Above this limit line, the measurement fails.
- Min: Below this limit line, the measurement fails.
- Delete: Delete limit line.

Begin stimulus: Frequency of the limit line’s starting point.

End stimulus: Frequency of the limit line’s ending point.

Begin response: Response of the limit line’s starting point.

End response: Response of the limit line's ending point.

8.8 Point Limit test

Overview

Point Limit is a test form that can visualize test data and results. The limit test compares the measured data with the defined limit and provides the **qualified** or **unqualified** judgment information of the measured data point. Point Limit and limit test are not suitable for **smith** chart and **polar** display formats, and point limit and limit test functions are automatically disabled for these display types.

Point Limit table setting

Click **Math** → **Analysis** → **Point Limit** and the pop-up dialog box is shown in the figure below. Point Limit Test, Sound Type, Point Limit Table can be set in this interface.

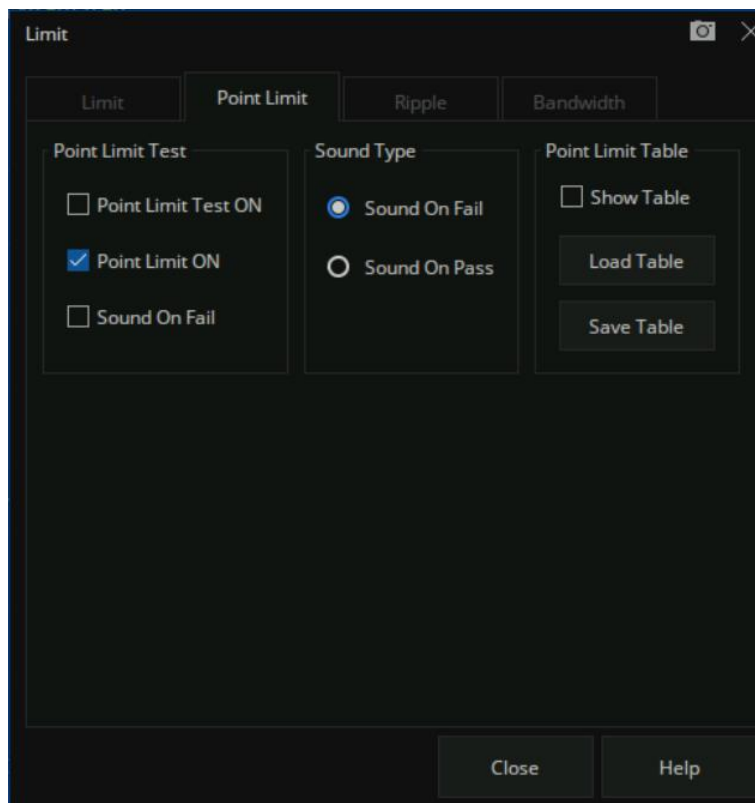

Figure 8-8 Point Limit test interface

Point Limit test:

- Point Limit test on: Check this box to compare the data with the limit and display “pass” or “Fail” judgment result.
- Point Limit on: Check this box to display the limit on the screen.
- Sound on fail: When this box is selected, when the measurement point fails in the limit test, a beep will sound.

Sound type:

- Sound on fail: When this box is checked, the equipment will beep when the test fails.
- Sound on pass: When this box is checked, the equipment will beep when the test passes.

Point Limit table:

- Show table: Check this box to open a table at the bottom of the screen to create and edit point limits.
- Load table: Call the saved limit table, The saved format of the limit table is CSV by default.

Point Limit setting

Click **Math** → **Analysis** → **Limit Table** → **Point Limit** to open the point limit setting interface, we can also click **Math** → **Analysis** → **Limit** → **Point Limit** → **Show Table** to open the point limit setting interface, as shown in the figure below.

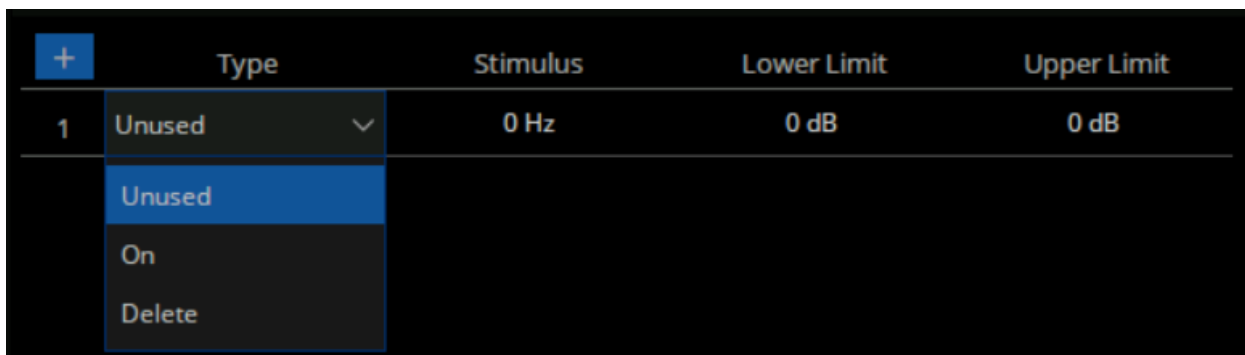

	Type	Stimulus	Lower Limit	Upper Limit
1	Unused	0 Hz	0 dB	0 dB

Figure 8-9 Point Limit setting interface

Point Limit type:

- Unused: Invalid point limit.
- On: Open point test limit.

- Delete: Delete point limit.

Stimulus: Frequency of the point limit.

Lower Limit: Lower limit of response value for point limit.

Upper Limit: Upper limit of response value for point limit.

8.9 Ripple limit test

The ripple limit test function can be performed independently of the limit test function, and the ripple limit can be set to evaluate whether the measurement result is qualified or unqualified. Ripple is defined as the difference between the maximum value and the minimum value within the specified excitation range. The ripple limit function is only applicable to the measured point value, not to the interpolation.

Ripple table setting

Click **Math** → **Analysis** → **Limit** → **Ripple** to open the ripple test setting interface, we can set ripple test, sound type, and ripple table in this interface.

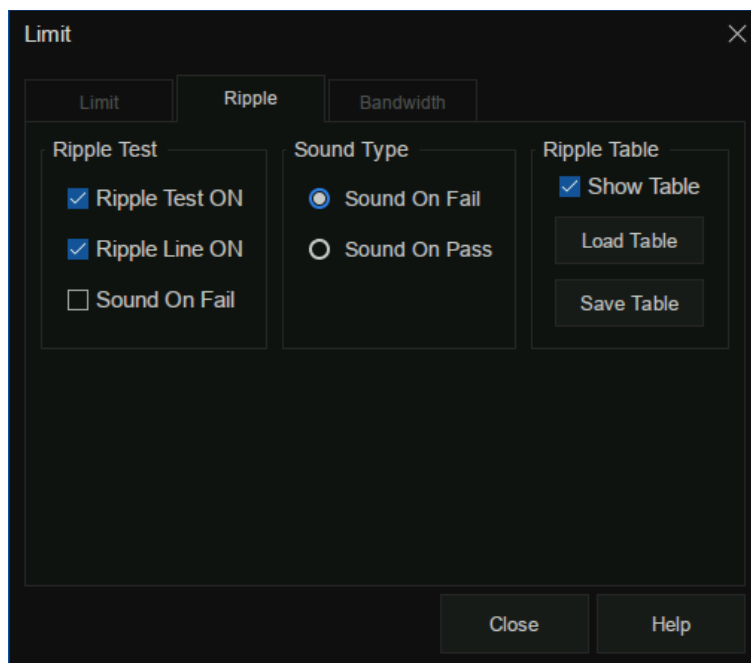

Figure 8-10 Ripple test setting interface

Ripple test:

- **Ripple test on:** Check this box to set the ripple test to “on” state and display “pass” or “Fail”.

- **Ripple line on:** Check this box to display the ripple limit line on the screen.
- **Sound on fail:** When this box is checked, the VNA will beep when the test fails.

Sound type:

- **Sound on fail:** When this box is checked, the equipment will beep when the test fails.
- **Sound on pass:** When this box is checked, the equipment will beep when the test passes.

Ripple table:

- **Show table:** Check this box to display a table at the bottom of the screen for creating and editing limits.
- **Load table:** Call the saved ripple limit table.
- **Save table:** Save the ripple limit table, the saved format of the ripple table is CSV by default.

Ripple limit line setting

Click **Math** → **Analysis** → **Limit Table** → **Ripple** to open the ripple limit setting interface, we can also click **Math** → **Analysis** → **Limit** → **Ripple** → **Show Table** to open the ripple limit setting interface, as shown in the figure below.

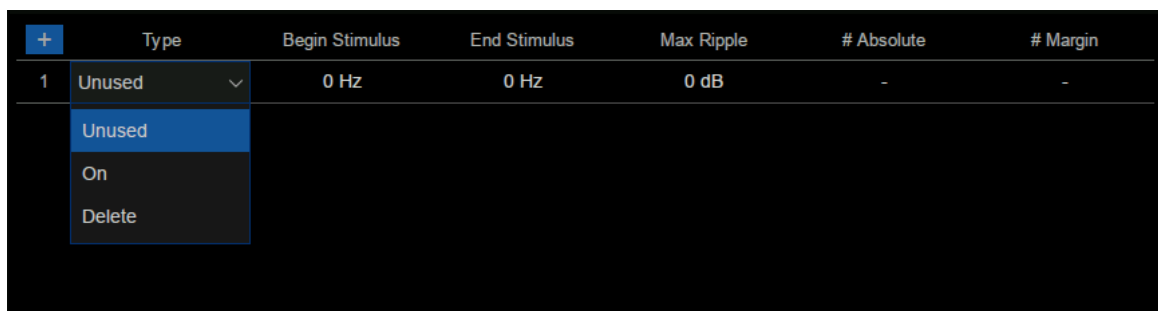

	Type	Begin Stimulus	End Stimulus	Max Ripple	# Absolute	# Margin
1	Unused	0 Hz	0 Hz	0 dB	-	-

Figure 8-11 Ripple limit setting interface

Type:

- **Unused:** Invalid ripple test line.
- **On:** Open ripple test limit line.
- **Delete:** Delete ripple test limit line.

Begin stimulus: Frequency of ripple limit line's starting point.

End stimulus: Frequency of ripple limit line's ending point.

Max ripple: Maximum value of ripple test.

Absolute: The difference between the maximum and minimum in the frequency band.

Margin: The difference between the absolute value of ripple and the limit value.

8.10 Bandwidth limit test

The bandwidth limit test function can be used to test the bandwidth of a bandpass filter. The bandwidth limit test can find the peak value in the bandwidth, and find the frequency points lower than the specified value of the peak value on the left and right sides of the peak point, and the frequency between these two points is the filter bandwidth, and then compare the obtained bandwidth with the minimum and maximum allowable bandwidth specified in advance.

Bandwidth test setting

Click Math → **Analysis** → **Limit** → **Bandwidth** to open the broadband test setting interface, we can set bandwidth test, sound type, and target bandwidth in this interface.

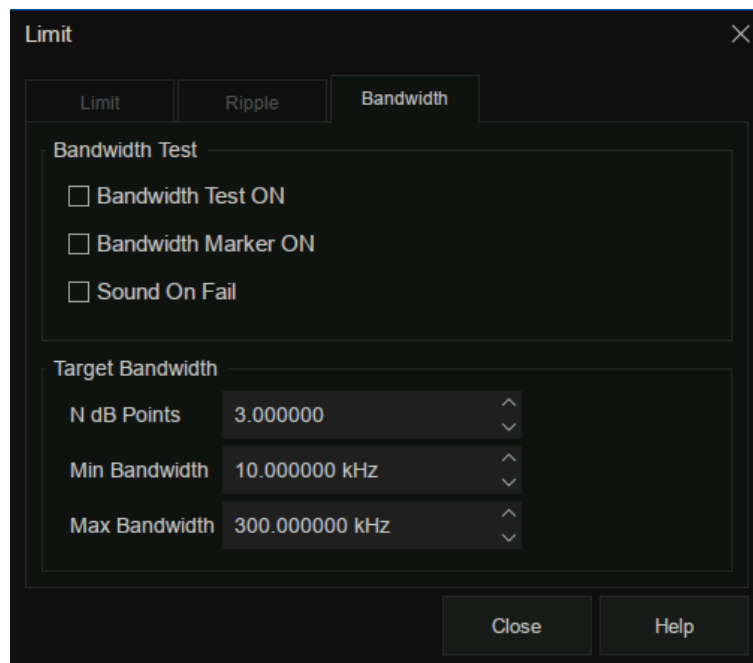

Figure 8-12 Bandwidth test setting interface

Bandwidth test:

- **Bandwidth test on:** Check this box to set the bandwidth limit test state to on.
- **Bandwidth marker on:** Check this box to display the bandwidth on the screen.
- **Sound on fail:** When this box is selected, an alarm will sound when the bandwidth limit test fails.

Target bandwidth:

- **N dB points:** Specifies the bandwidth threshold in dB.
- **Min bandwidth:** Enter the lower limit of bandwidth in Hz.
- **Max bandwidth:** Enter the upper limit of bandwidth in Hz.

Note: If the data format is Smith chart or polar coordinate format, the bandwidth test is skipped.

8.11 Time domain

A vector network analyzer is usually used to measure the frequency domain characteristics of the DUT. For the time domain characteristics of the DUT, the frequency domain parameters can be obtained by inverse Fourier transform. The time-domain characteristics use time as the horizontal axis to display the measurement results. Then the characteristics of the DUT can be observed from two different visual angles of frequency domain and time domain by the vector network analyzer.

8.11.1 Transform

Click **Math** → **Time Domain** → **Time Domain Setup** → **Transform** to open the time domain transform setting interface, we can set the start time, stop time, center time, span, transform mode in this interface.

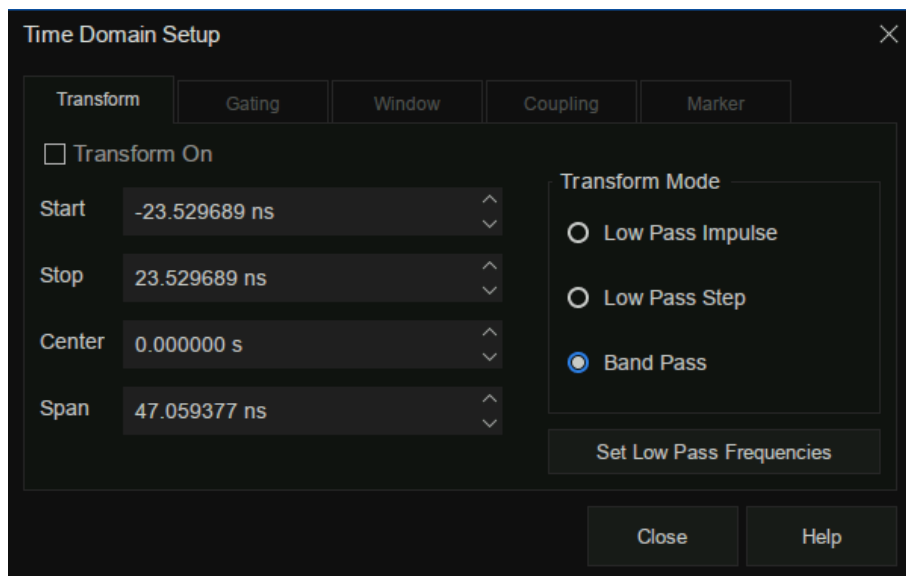

Figure 8-13 Time domain setting interface

Transform switch: Check the transform switch to switch to time-domain mode.

Start time: Set the start time of transformation displayed.

Stop time: Set the stop time of transformation displayed.

Center time: Set the center time of transformation displayed.

Time span: Set the time span of the transformation displayed on the screen of VNA.

Transform mode:

- **Low pass impulse:**

High resolution, suitable for viewing the small response of the device propagating low-frequency signal. In this low pass impulse mode, the frequency expands to DC and negative frequency. Therefore, when we click **Set Low Pass Frequencies**, the starting frequency will be automatically adjusted, which will affect the calibration accuracy. Therefore, it is necessary to calibrate after setting the time domain measurement parameters.

- **Low pass step:**

The simplest way to determine the discontinuities caused by inductors and capacitors in equipment that propagate low frequency signals.

- **Bandpass:**

The simplest method, which can be used with any frequency sweep, it is most useful when measuring devices with limited bandwidth. Capacitance and inductance reactance will not be

shown. For the same frequency range and number of points, the bandwidth of bandpass mode is twice that of impulse mode, which will hide the closely spaced response and reduce the response resolution. The measurement range is inversely proportional to the frequency step.

Set low pass frequencies:

It can only be used in low pass mode. After clicking **Set Low Pass Frequencies**, the measurement range is inversely proportional to the starting frequency. Recalculate the start frequency and step frequency as the harmonics of the starting frequency. Calculate the starting frequency according to the formula of low pass start frequency = stop frequency/points. The calculated value must not be less than the minimum frequency of the vector network analyzer. The number of points or stop frequency may change.

8.11.2 Gating

The gating function of a vector network analyzer is the most useful feature in time domain transform. When the time domain characteristics of the equipment need to be viewed, the gating function can only choose the required time-domain response, eliminate unnecessary time domain response, and then view the frequency domain characteristic curve of the required response through Fourier transform. The gating function enables the DUT to be characterized without connectors or adapters.

Click **Math** → **Time Gating** → **Gating Setup** → **Gating** to open the gating setting interface, then we could set the start time, stop time, center time, span, gate type, and gate shape in this interface.

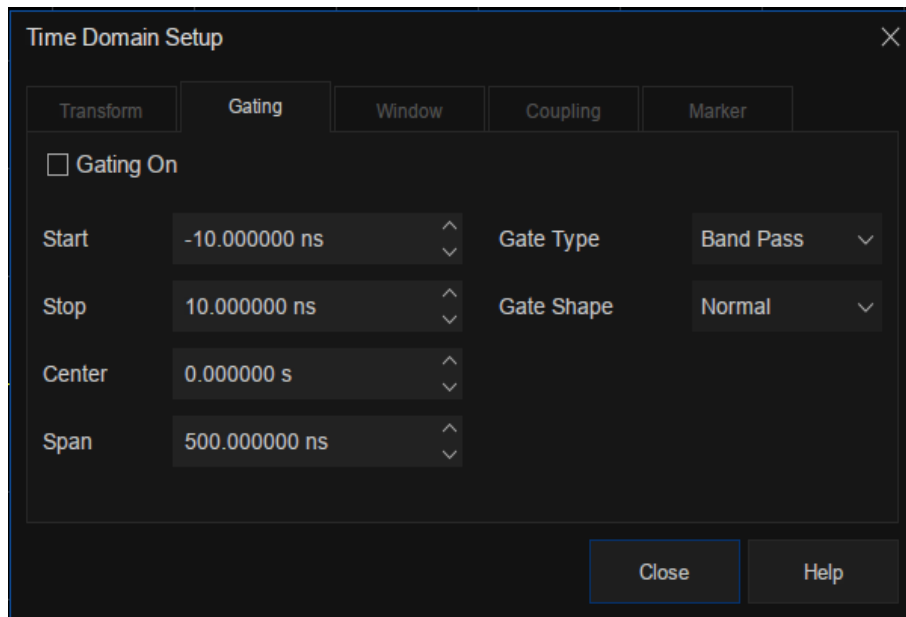

Figure 8-14 Gating setting interface

Gating on: Open or close the gating function.

Start time: Set the start time of gating.

Stop time: Set the stop time of the gate.

Center time: Set the center time of the gate.

Time span: Set the time span of the gate.

Gate type: Sets the type of filtering performed by the gating function.

- **Bandpass:** Keep the response in the gating span.
- **Notch:** Remove response using the gating span.

Gate shape: Set the filter characteristics of the gating function. There are four options: minimum, normal, wide, and maximum.

The parameter definition of the gating function is shown in the figure below:

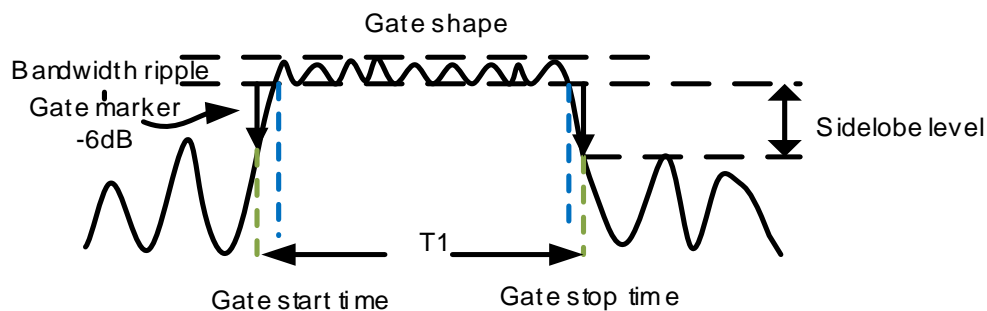

Figure 8-15 Diagram of gating

Parameter description of gating function:

Gate shape	Bandwidth ripple	Sidelobe level
Minimum	± 0.1 dB	-25dB
Normal	± 0.1 dB	-45dB
Wide	± 0.1 dB	-52dB
Maximum	± 0.01 dB	-80dB

8.11.3 Window

There will be sudden changes in the start and stop of frequency domain parameter measurement, which will lead to overshoot and ringing in the time domain. The window function is helpful to reduce the overshoot and ringing in the process of frequency domain and time domain conversion.

Click **Math** → **Time Gating** → **Gating Setup** → **Window** to open the window setting interface, we can set the window size, The size of the window should be balanced between response resolution and dynamic range. Setting the minimum window can get the best response resolution, and setting the maximum window can get the maximum dynamic range.

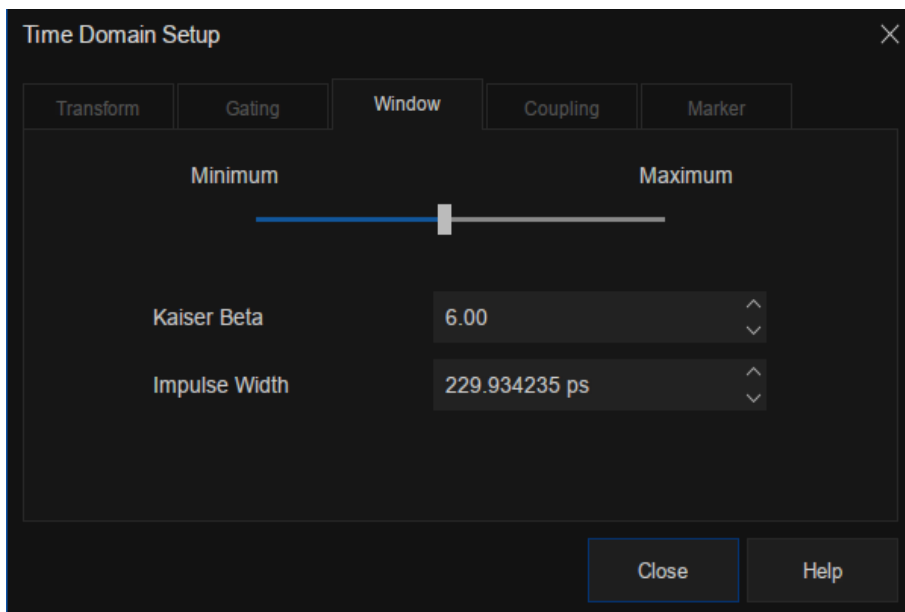

Figure 8-16 Window setting interface

Three methods of setting window size:

- **Minimum-maximum:** Use the mouse or touch screen to move the slider to change the window size.
- **Kaiser Beta:** Use the value of Kaiser Beta to change the window size.
- **Impulse width:** Use the value of impulse width to change the window size.

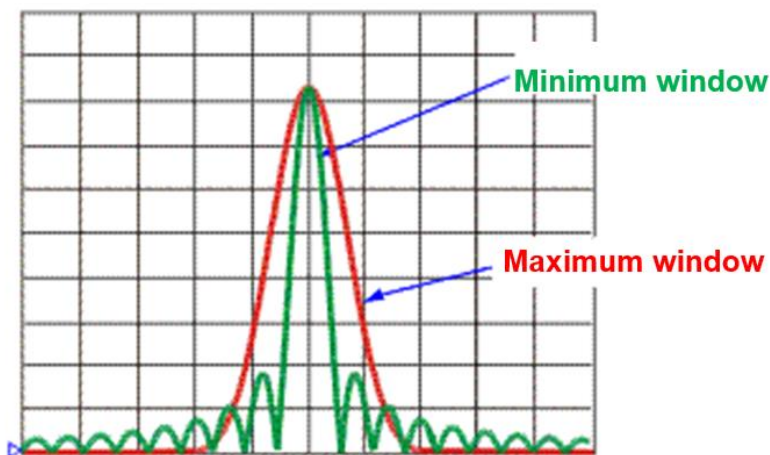

Figure 8-17 Diagram of maximum and minimum window

8.11.4 Coupling

Trace coupling allows to change the measured time-domain parameters and make all other measured parameters in the channel change the same. For example, to view the frequency-domain and time-domain measurement parameters at the same time, first turn on the coupling switch and select all the gating parameters in the coupling setting interface, at the same time, the parameters of gate span are changed in time domain measurement, the frequency-domain measurement parameters will be changed automatically to reflect the effect the time domain gate span parameters are modified. The trace coupling is only applicable to Y-axis scale / reference settings. The results of trace coupling do not change the measured data.

Click **Math** → **Time Gating** → **Gating Setup** → **Coupling** to open the coupling setting interface, we can set transmission parameters and gating parameters in this interface.

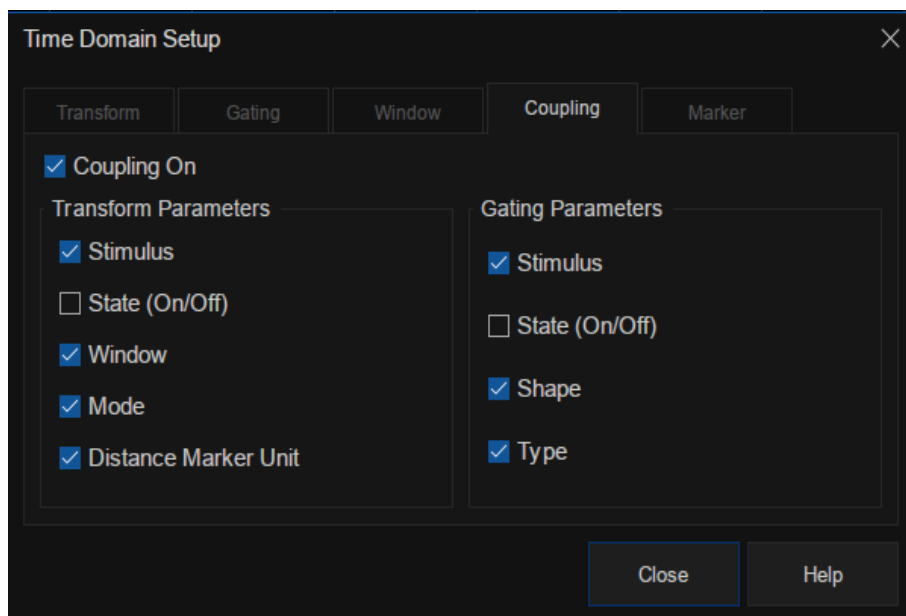

Figure 8-18 Coupling setting interface

Coupling on: Click to enable coupling. At this time, all measurements in the channel are coupled. The following conversion parameters and gating parameters can be used for coupling.

Transform parameters:

- **Stimulus:** Setting of the start time, stop time, center time, and span.
- **State(On/Off):** State of the transform.

- **Window:** Kaiser Beta and pulse width parameter.
- **Mode:** Low pass pulse, low pass step, bandpass.
- **Distance marker unit:** When selected, all measured distance marker units are coupled.

Gating parameters:

- **Stimulus:** Setting of the start time, stop time, center time, and span.
- **State (On/Off):** Switch of gating function.
- **Shape:** “Minimum”, “normal”, “wide” and “maximum”.
- **Type:** Bandpass and notch filtering.

8.11.5 Marker

When a marker is added to a time-domain parameter, the distance parameter is automatically displayed in the marker reading. These settings only affect the display of all markers of the active measurement (Unless the distance marker unit is coupled in the trace coupling box).

Click **Math** → **Time Gating** → **Gating Setup** → **Marker** to open marker setting interface. Set the marker mode, units, and velocity factor in this interface.

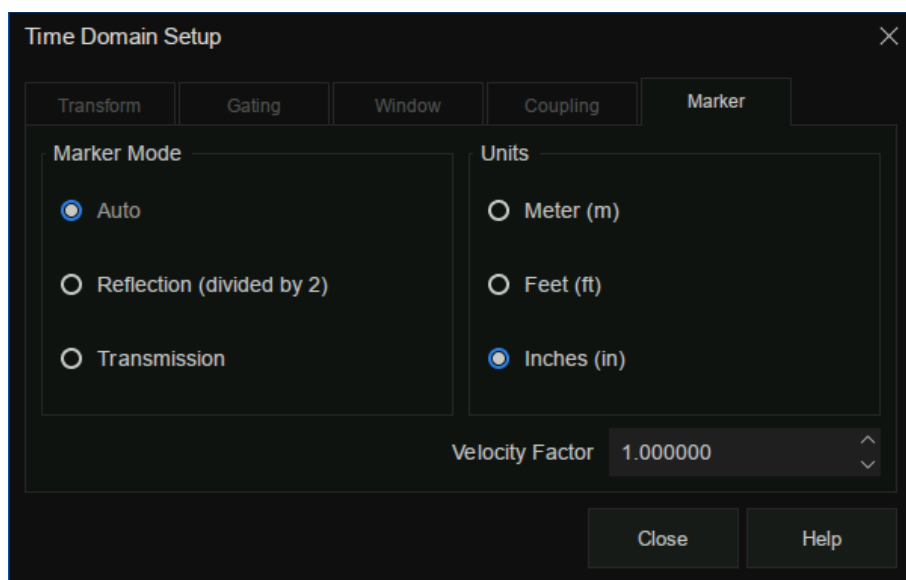

Figure 8-19 Marker setting interface

Marker mode: Specify the marker mode to determine the correct marking distance displayed.

Generally, **Auto** can be selected when measuring S parameter, and **Reflection** or **Transmission** can be selected when measuring any ratio parameter.

- **Auto:** If the measurement parameter is S parameter, **Reflection** or **Transmission** will be selected automatically. If the measurement parameter is a non-S parameter, **Reflection** will be selected automatically.
- **Reflection:** Displays the distance from the source to the receiver and the return path, then divides by 2 (compensated return path).
- **Transmission:** Displays the distance from the source to the receiver.

Units: Specifies the unit for the displayed marker distance value, there are three options: meter, feet, and inches.

Velocity factor: Set the velocity factor of the transmission line, where the value of PE is 0.66, PTFE is 0.7 and the corresponding value of vacuum is 1.

8.11.6 Advance

Description

In time-domain low-pass pulse and step transformation modes, users can choose to use the automatic extrapolation function provided by the instrument to determine the DC component value, or customize the extrapolation value.

DC Value

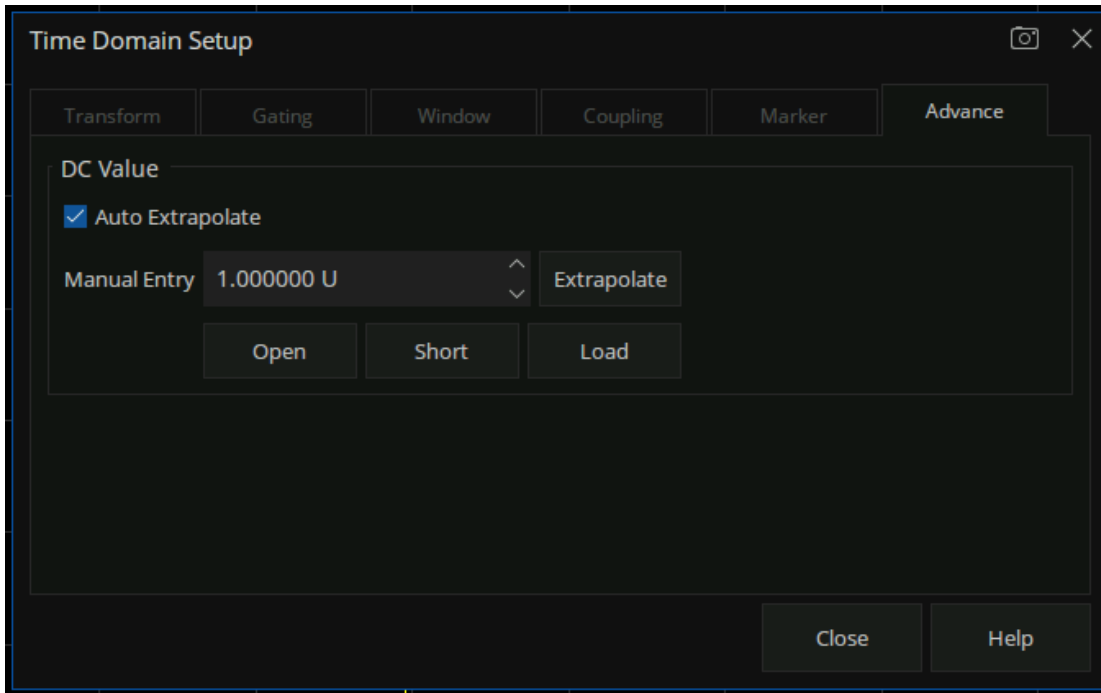

DC Value Setting

Entry: Math → Time Domain → Time Domain Setup → Advance → DC Value

Auto Extrapolate Switch: (Auto Extrapolate) Used to turn on or off the automatic extrapolation processing of the instrument.

User Manual Entry: Users can manually enter custom DC values or click on the Extrapolate button to obtain the values extrapolated by the instrument based on the latest data. In addition, the UI also provides convenient input of Open, Short, and Load configuration values, allowing users to freely choose appropriate extrapolation values based on the DUT type.

9 Save and Recall

The vector network analyzer supports save and recall functions for files of various formats. Press the **Save/Recall** button on the front panel and select file, data, calibration data, and images to save or recall, in the menu bar on the right side of the screen.

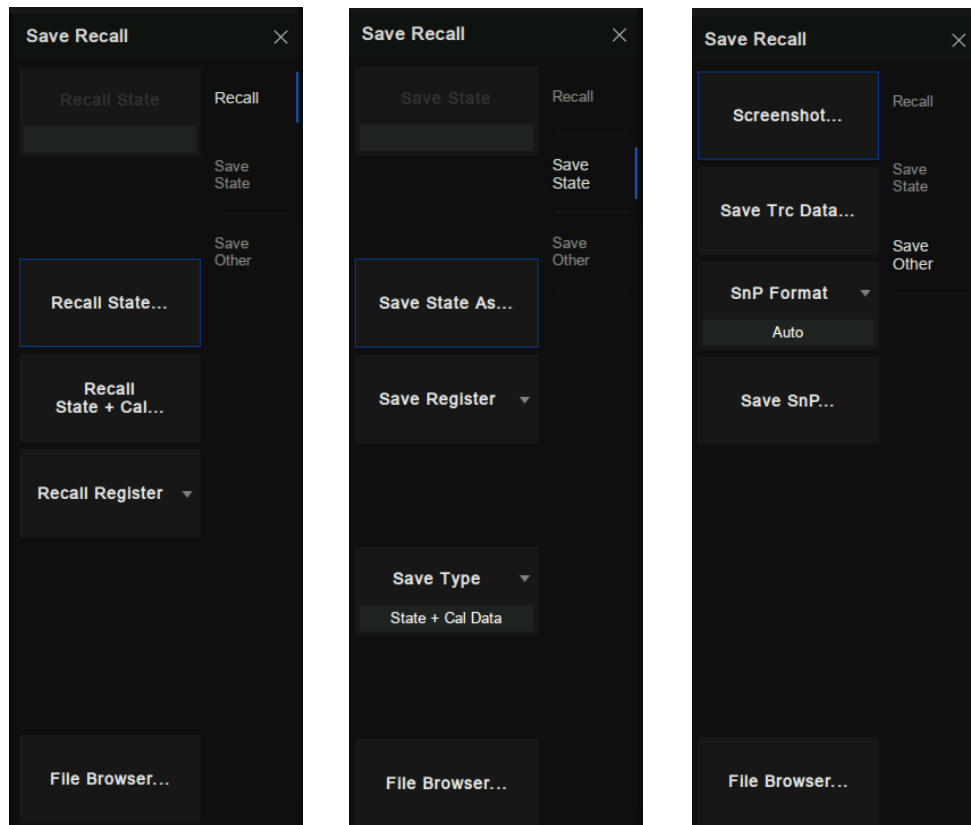

Figure 9-9-1 Operating interface

Description of supported file formats:

- STA file: The state file contains the configuration parameters (setup) of the instrument.
- CSA file: The calibration data and state file.
- CSV file: Trace data.
- SnP file: Also known as a Touchstone file. It contains the S parameter information.
- PNG /JPG /BMP file: Screenshot/exact copy of the display.

Save file:

- **Save the status of equipment:**

Use the Save State As command in the Save State submenu to save the equipment state.

- **Save the status and calibration data of equipment:**

Select State + Cal Data command in the Save Type submenu to save the equipment state and calibration data at the same time.

- **Save trace data:**

Use the Save Trc Data command in the Save Other submenu to save the trace data in CSV format; or use the Save SnP command to save the trace data in SnP format. When saving the trace data in SnP format, you can select the following formats: LinMag / Angle, LogMag / Angle and Real/ Imaginary in the SnP Format drop-down item.

- **Save screenshot:**

Use the Screenshot command in the Save Other submenu to save the screenshot. We can set the default path in the pop-up dialog box. The screenshot file type can be saved as PNG/ JPG/ BMP file formats.

- **Save register data:**

Use the Save Register command in the Save State submenu to save the data in the register.

Recall file:

- **Recall status of equipment:**

Use the Recall State command in the Recall submenu to select the required equipment state in the .sta file format.

- **Recall the status and calibration data of equipment:**

Use the Recall State + Cal command in the Recall submenu to select the required equipment state and calibration data in .csa file format.

- **Recall register data:**

Use the Recall Register command in Recall submenu to select the register data to be recalled.

File management:

Click **File Browser** command to open the file browser, File management can be carried out in the file browser.

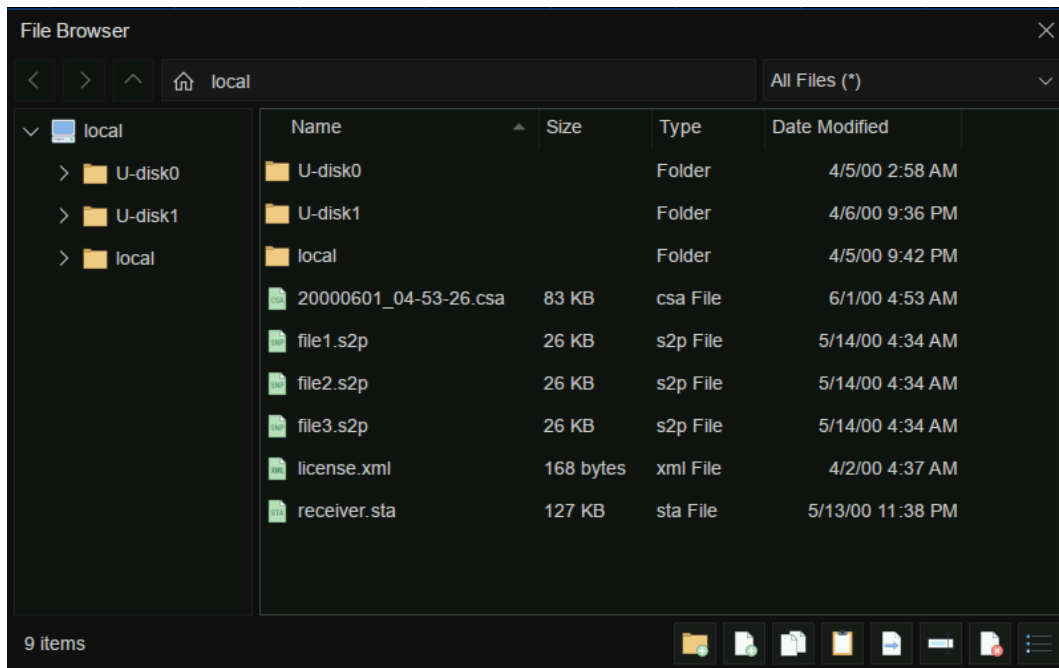

Figure 9-9-2 File management interface

10 Guide For the TDR Option

10.1 Overview

Measured frequency responses can be transformed to the time domain to analyze the time-domain characteristics of the DUT. The TDR option provides the time domain reflection/transmission analysis functions and eye diagram simulation function, which can help users save time and money by minimizing the need for other test equipment. Time domain analysis also has some irreplaceable advantages:

1. Time-domain analysis shows the positions and properties of the impedance discontinuities on DUT. It can be easy to acquire the impedance value at any point on the transmission line by analyzing the time domain reflection characteristics. It's helpful to locate the faults on transmission lines.
2. Using the time domain gating function to remove the influences of the impedance discontinuities, it becomes possible to simulate the frequency domain characteristics of DUT after the faults are removed.
3. The eye diagram simulation function doesn't need any external waveform generators. The VNA uses a built-in virtual bit pattern generator to provide the input signal. It's a very important tool for signal integrality analysis.
4. If you want to design a compensation network for high-speed digital signal transmission by emphasis/ de-emphasis or equalization, the advanced waveform function in TDR waveform will be of vital use for you. You don't need to change the DUT connection or any extra devices, it's easy to simulate the eye diagrams with the different compensation methods.
5. You can directly inject jitter into the input signal for eye diagram simulations. A statistical eye diagram is introduced to simulate the probability density of the output signals.

When using the TDR option, there are some notes:

1. When opening the TDR option or switching the DUT topology, calibration and deskew data will be cleared. Please finish the calibration wizard before measuring to get the correct results. Save the calibration data and recall it when required, which can avoid unnecessary calibration operations.
2. Please operate in the bottom toolbar of the TDR menu as far as possible. The function in the TDR option depends on the time domain transform, so changing settings in the right toolbars can lead to incorrect transform results.
3. Don't close the eye diagram module while the eye diagram is drawing, or an unexpected error

might occur. Unless necessary, don't switch between the TDR/TDT module and the eye diagram module, for the last eye diagram will be drawn when it's switched to the eye diagram module, which might take a long time.

4. It's NOT recommended to add too many traces, or the trace data update will be slow.
5. If there are too many windows or too much information in a window to observe the information or traces, it will be useful to maximize the window or trace.

10.2 Open/Close/Preset TDR Option

To switch on the TDR option, use the order **Math->TDR->TDR**, then the button "On" will be selected. The TDR toolbar will appear at the bottom of the screen, and the TDR option function will be open to the user. If you have the trial license for the TDR option, an information dialog will appear to notify you that the trial times will decrease. If the trial times expire, a permanent license is needed to switch on the TDR option.



Figure 10-10-1 TDR Option interface

To close the TDR option, use the order **Math->TDR->TDR** again, then the button "Off" will be selected,

VNA will restore the state before the option opened. Click the  button at the top right corner of the TDR toolbar will close the TDR option too.

Click the **Preset** button in the **Basic** bar of the **Setup** tab in the TDR toolbar and the VNA will preset the TDR option: Clear the calibration data, allocate the traces and windows automatically, and reset the settings in the option. After the TDR option is started, the calibration wizard will need to be run again.

10.3 TDR Setup Wizard

The TDR setup wizard pops up when the TDR option is switched on for the first time. Click the checkbox “**Show this wizard next start-up**” to decide whether the wizard pops up when opening the option or not. The wizard can be opened by clicking the **Setup Wizard** button in the **Basic** bar of the **Setup** tab in the TDR toolbar.

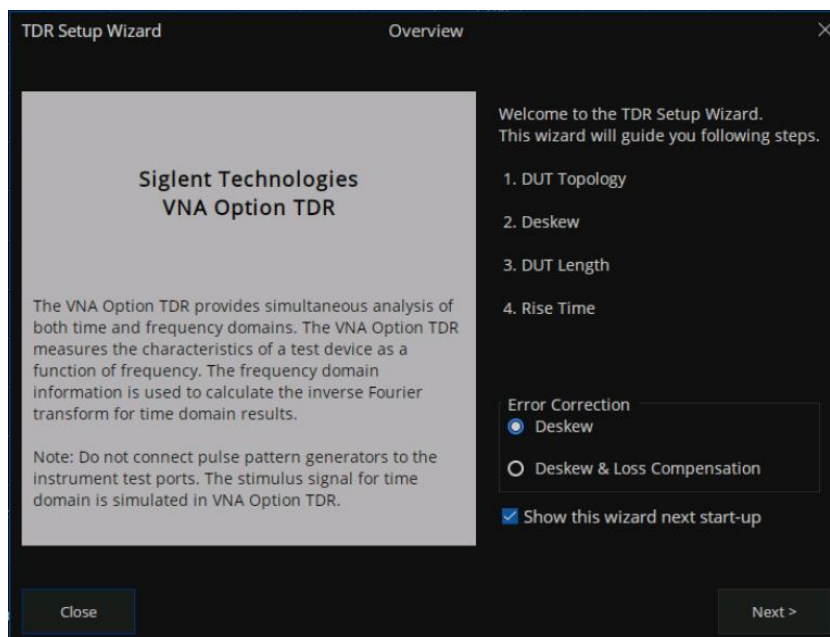

Figure 10-10-2 TDR Setup Wizard

The wizard will guide you to finish the DUT topology selection, port extension setup, DUT length measurement, and stimulus rise time setting. The calibration type can be selected in the **Error Correct** bar on the first page of the wizard, and the wizard will also guide you to finish the calibration you select. The calibration operation will be illustrated in detail in the section “**TDR calibration**”.

If you don't need to finish the setup in the wizard immediately, you can close the wizard. But the

calibration is necessary before accurate measurement or analysis.

10.4 Calibration for TDR Option

There are two calibration types in the TDR option: **Deskew** or **Deskew & Loss Compensation**. The former only moves the reference plane to the end of the cables connected to the ports of VNA, ignoring the signal loss in the cables. And the latter tries to compensate the loss in the cables.

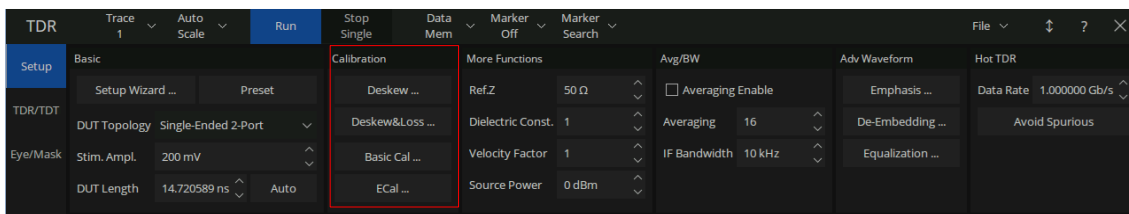



Figure 10-10-3 TDR Calibration Tab

10.4.1 Deskew

Click the **Deskew** button in the **Basic** bar of the **Setup** tab in the TDR toolbar to open the **Deskew** dialog. Connect all cables and fixtures to the VNA, and connect the other ends of the fixtures to nothing or the OPEN calibration kit. Then click the **Deskew** button in the dialog, and click the **Finish** button after a  mark appears at the **Deskew** button to finish the Deskew calibration.

Click the **Option** button to open the **Deskew Option** dialog, in which you can select the calibration type or operate the calibration one-by-one for each port. The calibration type can be selected by the **Standard Type** pull-down menu. It's set to **Open** by default. If you choose the **Short** option, you should connect the SHORT calibration kit to the port to finish the calibration. You can calibrate only one port at a click on the corresponding **Port** button, but you should finish the calibration of all ports to finish the task in the dialog.

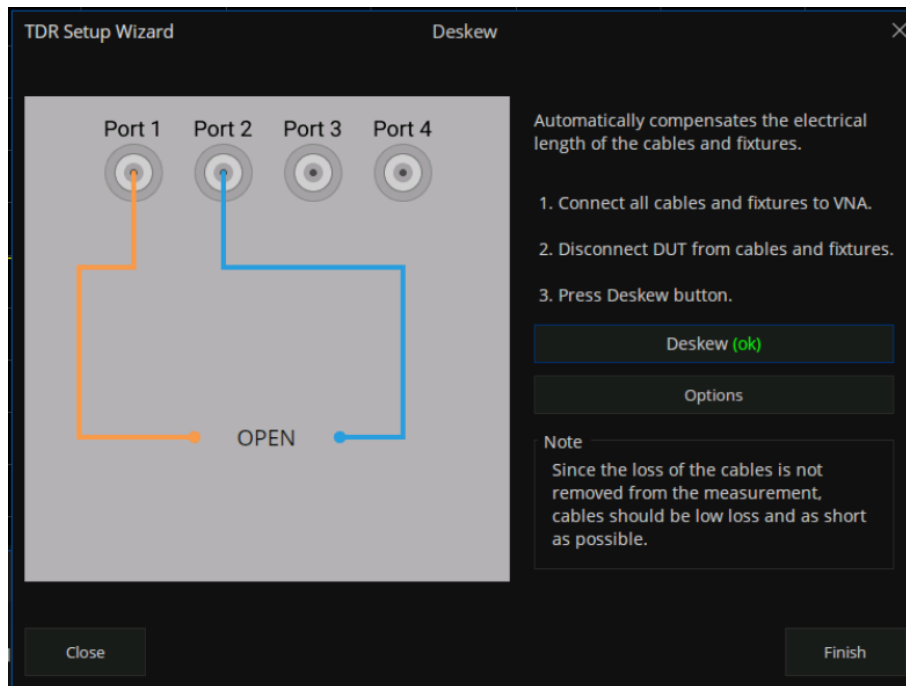



Figure 10-10-4 TDR Deskew Wizard

10.4.2 Deskew & Loss Compensation

Click the **Deskew&Loss** button in the **Basic** bar of the **Setup** tab in the TDR toolbar to open the **Deskew & Loss Compensation** wizard. The wizard can be divided into 3 steps, which guide you to finish the Deskew and Loss Compensation calibration.

At the first step, a Deskew calibration is required. The method is the same as the operation introduced in the section “Deskew”.

At the second step, the calibration operation depends on the correct DUT topology. Under the topology Single-Ended 1 Port, you need to connect the cables and fixtures to the VNA, connect the other ends of the fixtures to nothing or an OPEN calibration element. Click the **Measure** button in the wizard, wait for the  mark to appear at the **Measure** button to finish the second step of calibration. Under other DUT topologies, you need to connect two cables and fixtures, which are connected to the ports as the wizard instructs, to both ends of a THRU calibration kit. Click the **Measure** button in the wizard, wait for the  mark to appear at the **Measure** button, then execute the next operation. If under Single-Ended 4-Port or Differential 2-Port, you will need to execute the operation as stated above once for each page of the wizard respectively to finish the second step.

At the third step, you can connect the LOAD calibration element to every port, and click the corresponding **Port** button to execute the calibration step. The step is optional, so it's not necessary to finish the calibration wizard.

If you finish all necessary calibration operations, click the **Apply** button to save and apply new calibration data, and click the **Finish** button to close the wizard.

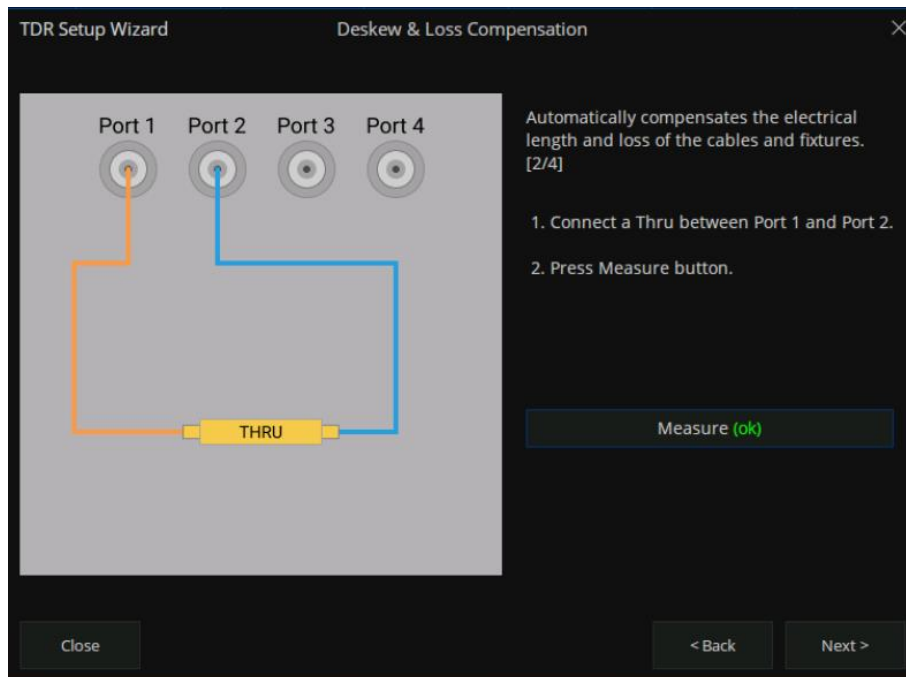

Figure 10-10-5 TDR Deskew & Loss Wizard

At any step of the wizard, it's allowed to execute a calibration operation repeatedly, new measured data will replace original data. You can click the **Close** button to close the wizard, which will give up all data measured in the wizard unless you have clicked **Apply** button to save them.

10.5 TDR Channel Setup

When the TDR function is activated, the current state is saved, and all existing traces and channels are deleted, and a new channel is added for the option. When the option is closed, all traces and the channel being used are deleted, and the instrument is returned to the state before TDR was opened.

The current channel settings can be changed in the TDR toolbar at the bottom of the screen, usually in the **Setup** tab.

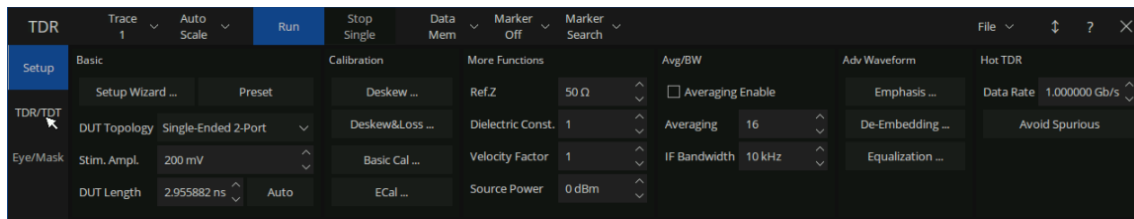

Figure 10-10-6 TDR Setup Tab

10.5.1 DUT Topology

In addition to the Setup wizard, the DUT topology can be changed in the **DUT topology** pull-down menu in the **Basic** bar of the **Setup** tab. The traces and windows are allocated automatically according to the DUT topology.

If the DUT topology is changed, the calibration and deskew data will be cleared. Recalibration becomes necessary before an accurate measurement or analysis. If the calibration data is hoped to be held, save the state in time and recall it when required.

10.5.2 DUT Length

The DUT length means the time that the signal takes to transmit through the DUT or reflect the incident plane and is required to show the time-domain responses of DUT in full. The sweep frequency span and points of the channel are set according to the DUT length, and the span of the transformation is automatically calculated by the DUT length when the time domain traces are set in the time axes. It's not recommended to change the sweep settings by other methods.

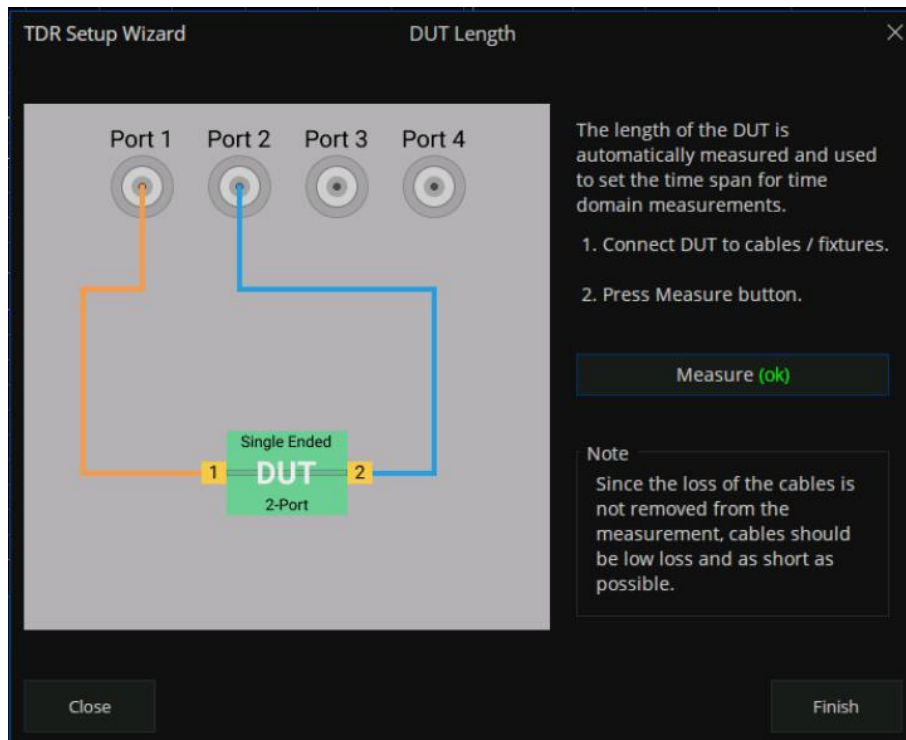



Figure 10-10-7 DUT Length measure wizard

In addition to the Setup wizard, the DUT length can be set in the **DUT Length** textbox in the **Basic** bar of the **Setup** tab. It's a convenient way to set the suitable value by measuring the DUT length in the **DUT Length** dialog. Click the **Auto** button on the left of the textbox to open the dialog, connect the DUT according to the picture and instructions in the dialog, click the **Measure** button and wait for the  mark to appear, click the **Finish** button to close the dialog, and finish the DUT length setting. If the measurement result is out of the default range, an information dialog will pop up to notify the users that the DUT length will be set to the maximum or minimum.

10.5.3 Stimulus Magnitude in Time Domain

The stimulus magnitude in the time domain can be set in the **Stim. Ampl.** textbox in the **Basic** bar of the **Setup** tab, which defines the magnitude of the impulse or step stimulus signal for the time-domain responses of the traces under the format **Volt**.

10.5.4 Port Impedance

The port impedance can be set in the **Ref. Z** textbox in the **More Function** bar of the **Setup** tab, which defines the reference impedance to calculate the impedance values of the traces under the

format **Impedance**.

10.5.5 Velocity Factor & Dielectric Constant

The velocity factor is the ratio of the velocity of the electric signal in the DUT to that in the vacuum. VNAs calculate the distances by the transmission or reflection time based on this factor, which provides the accurate positions of the impedance discontinuities. There is a functional relationship between the velocity factor and the dielectric constant of the materials. When either is changed, the other will be calculated by the equation below:

$$\text{Velocity Factor} = \frac{1}{\sqrt{\text{Dielectric Constant}}}$$

The velocity factor and dielectric constant can be set in the **Velocity Factor** and **Dielectric Const.** textboxes in the **More Function** bar of the **Setup** tab.

10.5.6 Power Level

The power level is the power of the test signal transmitted to the DUT, which can be set in the **Source Power** spinbox in the **More Function** bar of the **Setup** tab.

10.5.7 Average

The average function means that the final measure results are equal to the average of the measure results in the several sweeps in the same setting, and the number of sweeps needed depends on the averaging factor. The average function can decrease the random errors to some degree, but slow down the update of trace data. It's necessary to keep the characteristics and connection of the DUT unchanged during an average sweep.

To enable or disable the average function, click the **Averaging** checkbox in the **Average** tar of the **Setup** tab. The average factor can be set in the textbox to the right of the checkbox.

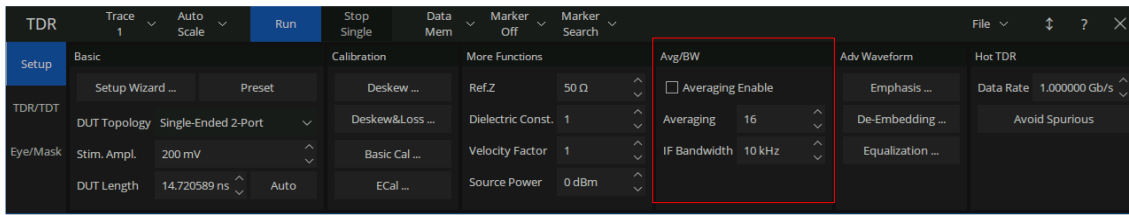

Figure 10-10-8 Avg/BW setting

10.5.8 IF Bandwidth

The IF bandwidth is the bandwidth of the intermediate-frequency filters in the receivers. A narrow IF bandwidth leads to lower trace noise levels and longer sweep times.

The IF bandwidth can be set in the **IF Bandwidth** textbox in the **Average** tar of the **Setup** tab.

10.5.9 Trigger Mode

The trigger mode gates the channel sweep state change when the trigger signal is detected. The trigger mode **Hold/Stop** means that sweep can't be started even if the trigger signal is detected. **Single** means that only one sweep is triggered by the trigger signal. Upon sweep completion, the trigger mode is set to **Hold/Stop**. **Continuous/Run** means that the trigger signal starts and continuously sweeps.

To switch the trigger mode to **Continuous/Run**, click the **Run** button at the top of the TDR toolbar. To switch the trigger mode to **Single**, click the **Stop/Single** button at the top of the TDR toolbar.

10.6 TDR Trace Setup

Without taking the set coupling into account, the settings as follows are applied to a single trace. Usually, the traces in the TDR option are in a time-domain coupling and marker coupling, meaning that the correlated settings are applied to all the traces. In addition, there is a set of default trace configurations for every DUT topology.

10.6.1 Select a Trace

In addition to clicking the trace or trace information bar on the screen, the **Trace** pull-down menu at

the top of the TDR toolbar has the same function.

10.6.2 Scale Management

In the TDR option, there are several automatic scale settings to use, and it is allowed to change the scale or reference value manually.

10.6.2.1 Auto Scale

To apply the automatic scale settings, click the **Auto Scale** button at the top of the TDR option and click the suitable option in the pull-down menu. Every option in the menu represents a set of automatic scale settings.

Option **X** means that the horizontal axis of the current trace is set automatically. For the traces in the time domain, the scale and reference value are calculated by the DUT length. For the traces in the frequency domain, the horizontal axis is set to the frequency sweep setting of the channel.

Option **Y** means that the vertical axis of the current trace is set automatically. The scale and reference value are calculated by the maximum and minimum of the trace data.

Option **X&Y** means that the horizontal and vertical axes of the current traces are set automatically. The method is the same as introduced above.

All Trace means that the horizontal and vertical axes of all the traces are set automatically. The method is the same as introduced above.

10.6.2.2 Manual Scale Setup

Manual calibration Settings are implemented through the Scale setting option in the TDR menu.

Horizontal is used to set the Horizontal coordinate and the reference point position, **Vertical** is used to set the Vertical coordinate and the reference value. Users click the corresponding edit box to enter the value through the number button on the front panel.

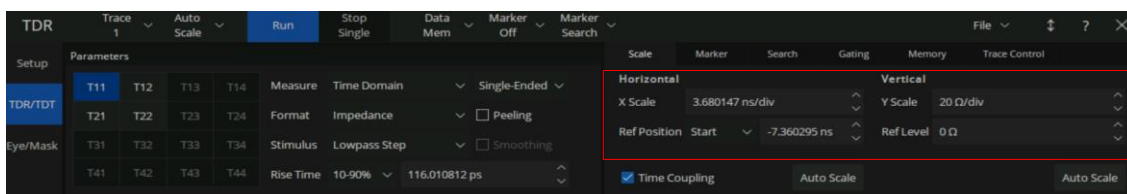

Figure 10-10-9 Scale Setup by manual

The vertical axis of the traces in the frequency domain has no concern with the sweep setting of the channel, only to set the displayed span of the trace data.

10.6.3 Memory Trace Management

Memory trace management is in the **Data/Mem** pull-down menu at the top of the TDR toolbar. Click the **Data->Mem** order in the menu, and the current trace data is saved to the memory trace. Other orders in the menu are display modes of the data trace and the memory trace for the current trace: The option **Off** means the data trace and the memory trace are invisible. The option **Memory** means only the memory trace shows in the window. The option **Data** means only the data trace shows. The option **Data&Mem** means both of them are visible.

10.6.4 Measure Parameter & Format

The measurement parameters and formats of the traces can be set in the **Parameter** tab of the **TDR/TDT** tab.

The physical significance of measurement parameters and formats in the frequency domain is the same as the general parameters of the VNA. In the time domain, T parameters are used as measurement parameters, meaning that the ratio of the magnitudes of the response signals received to the stimulus signals when a unit step / impulse stimulus signal is transmitted to DUT at time zero, in a span. For a specified DUT, S parameters are functions of the signal frequency, while T parameters are functions of the time under a specified stimulus type. T parameters show the unit step / impulse response of the DUT, which is of vital importance in the time domain system analysis.

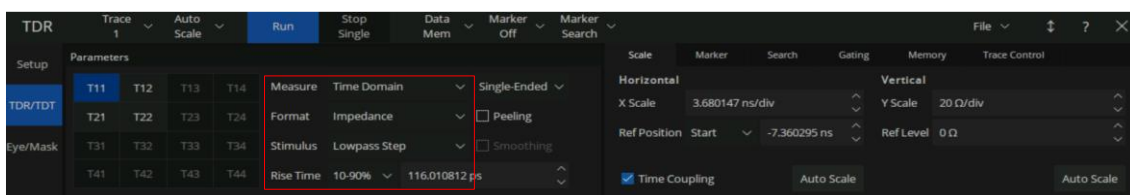

Figure 10-10-10 measure parameter setting

The formats of T parameters include **Log Mag**, **Lin Mag**, and **Real**, which are the same as S parameters; moreover, **Impedance** and **Volt** are added. T parameters show the time domain responses, so the values are always real numbers. In the other words, the imaginary parts are always zero. Therefore, Imaginary or phase formats aren't provided for T parameters in the TDR

option. The magnitude of **Log Mag** and **Lin Mag** formats is intrinsically the absolute values of the real parts of T parameters.

Impedance format is usually used for the reflection T parameters under a unit step stimulus. It calculates the impedance value of each point in the signal transmitting path by the reflection T parameters (reflection coefficients) under the unit step stimulus, which is on the base of the port impedance. The distances are calculated by the delay of transmission and the velocity factor. In the **Impedance** format, the positions and properties of impedance discontinuities in the DUT are shown on the traces visually, which provides a piece of important information for fault detection and removal. In the **Impedance** format, the TDR option regards the T parameters as the reflection coefficients ρ , and calculates the impedance by the equation as follow:

$$Z = Z_0 \cdot \frac{1 + \rho}{1 - \rho}$$

Volt format means the trace shows the time domain waveform of the response signal received under the specified stimulus. The magnitude of the stimulus signal is defined by the value in the **Stim.**

Ampl. textbox in the **Basic** bar of the **Setup** tab. Intrinsically, the **Volt** format means the trace data is a product of the T parameters and the magnitude of the stimulus signal.

Click the measure parameter button in the grids on the left of the **Parameter** bar, the measurement parameter of the current trace switches to the corresponding parameter. To switch on or off the time domain transform of the current trace, click the pull-down menu in the left of the **Measure** line. To switch to balance or unbalance parameters, click the pull-down menu in the right of the **Measure** line. To change the format, click the **Format** pull-down menu.

10.6.5 Stimulus in Time Domain

The stimulus type can be set in the **Stimulus** pull-down menu in the **Parameter** bar of the **TDR/TDT** tab. There are two stimulus types to choose: The option **Lowpass Step** means T parameters show the unit step responses and the option **Lowpass Impulse** means T parameters show the unit impulse responses.

The rise time or impulse width of the stimulus signal can be set in the Rise Time or Impulse Width textbox. Intrinsically, it controls the beta value of the Kaiser window function applied in the time domain transformation to weaken the sidelobes. Because the transformation is based on the finite frequency domain data, the data truncation at the end of frequency domain data leads to some problems, such as the extension of the rise time or impulse width of the responses signal and the appearance of sidelobes, which is called "truncation effect". Applying the Kaiser window lowers the

sidelobe levels, but aggravates the extension of the rise time or impulse width and brings down the resolution ratio of transformation. The longer the rise time or impulse width of the stimulus signal, the larger the beta value of the Kaiser window function, the stronger effects explained above are introduced into the transformation.

10.6.6 Smoothing

The smoothing function makes the trace data smooth by replacing the original trace data with the average of the data nearby. If the local change ratios of trace data are relatively large, the smoothing leads to large data errors. Therefore, the smoothing function is available for the traces whose measure parameters are reflection S parameters.

To switch on or off the smoothing function, click the **Smoothing** checkbox in the **Parameter** bar of the **TDR/TDT** tab.

10.6.7 Trace Allocation

The TDR option will delete all existing traces and windows, allocate all the traces and windows automatically for the DUT topology, and set the traces to default settings if the trace allocation function is activated. The operation deletes all original traces and their settings, but the channel settings remain. There are three allocation methods to choose from: The option **Mixed** means that the traces in the time and frequency domain are allocated. The option **All T** means that only traces in the time domain are allocated. The option **All S** means only traces in the frequency domain. Note that in Single-ended 1 Port topology, only the option **Mixed** is available.

To use the trace allocation function, click the button of the corresponding method in the **Allocation** box in the **Trace Control** bar of the **TDR/TDT** tab.

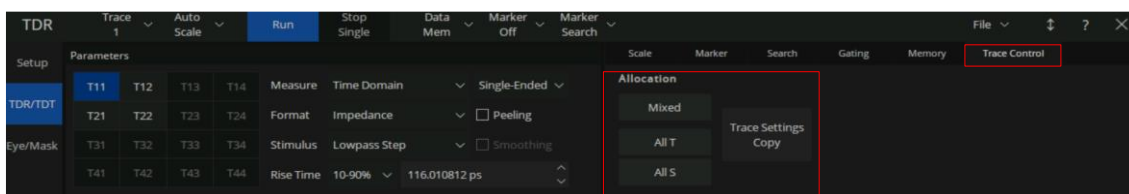

Figure 10-10-11 Trace Control Tab

10.6.8 Trace Setup Coupling

In the TDR/TDT Tab of TDR, users can select the Coupling box of the Scale, Marker, or Gating menu option to enable Time domain setting coupling, Marker coupling, or Gate coupling for traces.

10.6.9 Time Domain Gating

The time-domain gating function transforms the time domain response into the frequency domain after removing a part of the response. Usually, the function is used to simulate the expected frequency domain response after removing some faults by removing the abnormal responses resulting from the impedance discontinuities. The operation procedure includes enabling the time domain transformation, setting the parameter to remove partial time-domain responses, observing the other traces in the frequency domain whose gating settings are coupled with the trace, or close the time domain transformation to observe the frequency responses.

The time-domain gating settings in the TDR option can be changed in the **Gating** bar of the **TDR/TDT** tab.

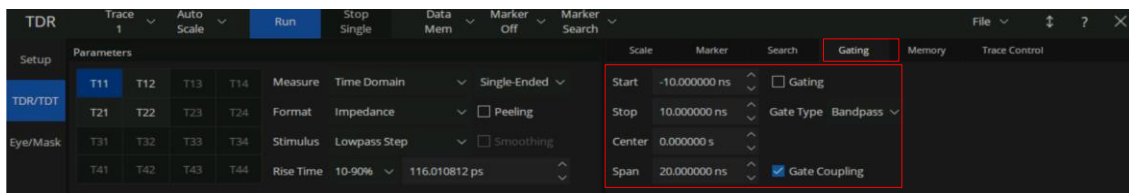

Figure 10-10-12 TDR Gating Tab

To switch on or off the time domain gating function, click the **Gating** checkbox.

To change the function type of the gating range, click the ratio button in the **Type** box. The option **Notch** means that the responses in the gating range will be ignored, while the option **Bandpass** means that the responses beyond the gating range will be ignored.

The scroll-wheel and textbox can be used to change the start and stop position of the time domain gating range.

10.6.10 DC Value

Description

In time-domain low-pass pulse and step transformation modes, users can choose to use the automatic extrapolation function provided by the instrument to determine the DC component value, or customize the extrapolation value.

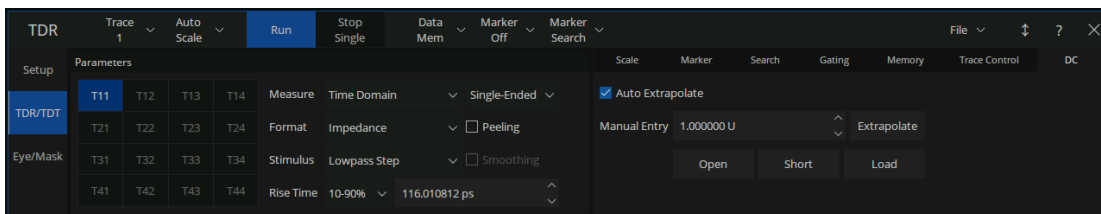

DC Value Setting:

Entry: TDR → TDR/TDT → DC

Auto Extrapolate Switch: (Auto Extrapolate) Used to turn on or off the automatic extrapolation processing of the instrument.

User Manual Entry: Users can manually enter custom DC values or click on the Extrapolate button to obtain the values extrapolated by the instrument based on the latest data. In addition, the UI also provides convenient input of Open, Short, and Load configuration values, allowing users to freely choose appropriate extrapolation values based on the DUT type.

10.7 TDR Data Analysis & Output

The general marker search function is available in the TDR option for data analysis, and there are some shortcuts provided at the top of TDR toolbar for marker management and search for maximum/minimum with tracking. In addition, the functions of the rise time search and delta time search are introduced as the time domain trace data analysis tools in the TDR option.

To correct the errors of impedance calculation resulting from the complicated distribution of mismatches in the DUT, a peeling algorithm is introduced to reveal the actual impedance value of every point on the passive DUTs.

The shortcuts to save/recall the state files, output the trace data to the files, and save the screenshot are provided in the **File** pull-down menu at the top of the TDR toolbar.

10.7.1 Marker Setup

In addition to the general ways to manage the markers in the VNA, the **Marker** pull-down menu at the top of the TDR toolbar is a way to add or delete markers.

The order in the first group of the **Marker Search** pull-down menu is shortcuts to manage the common marker tracking marker. The option **Off** closes the search function of the current marker, while the **Max** or **Min** starts the tracking search for maximum or minimum.

10.7.2 Rise Time Search

Rise time search is only available for the trace in the time domain, which searches for the rising or falling edge, sets a label to the start and stop, and displays the transition type and time at the top left corner of the window if successful. It's a tracking search, the results update if the trace data changes.

To switch on or off the rise time search, click the **Rise Time (10-90%)** or **Rise Time (20-80%)** option in the **Marker Search** pull-down menu. Selecting the suitable search type depends on the requirements.

10.7.3 Delta Time Search

Delta time search is only available for the trace in the time domain, which searches for the difference between the time where two traces rise or fall to a specified relative level in respective transition edge. If successful, a label will be set to the relative level on both traces, and the results will be displayed at the top left corner of the window that contains the start trace of the search. It's a tracking search, the results update if the trace data changes.

Click the **ΔTime...** order in the **Marker Search** pull-down menu to open the **ΔTime** dialog, and the settings of delta time search can be changed here.

Click the **Trace (Start)** pull-out menu to change the start trace of the search, click the **Trace (Stop)** pull-out menu to change the stop trace. A trace in the time domain can start one search at most as a start trace, while it's allowed that more than one searches set the same trace as the stop trace.

The target relative level of the search can be set in the **Position (%)** textbox in the dialog.

To switch on or off the search, click the **ΔTime Enable** checkbox.

10.7.4 Peeling

If there are two or more impedance mismatches on the DUT, a part of the incident wave is reflected at the first mismatch, the incident energy arriving at the next mismatch reduces, so the reflection at the next mismatch might seem weaker than that in reality. Calculating impedance using reflection coefficients might lead to obvious errors after the first mismatch. To avoid the effect of the masking phenomena explained above, a new approach to calculate impedance, called the peeling algorithm, is introduced in the TDR option. The algorithm divides the DUT into many sections, calculates the impedance of the next section by the impedance of the last section as the reference value, and the incident and reflected energy in reality.

The algorithm presupposes that the energy sum of input equals that of output at any points on the path the signal transmits through, which means that the signal transmits through the DUT without loss. This is an imperfection of the algorithm, and transmission loss always decreases the accuracy. Because of the recurrence method in the algorithm, the accuracy also decreases with the distance increases.

If the peeling function is enabled, the TDR option calculates impedance in the way explained above, instead of the traditional way. The function is available only if the format of the trace is **Impedance** of the reflection T parameters. To switch on or off the function, click the **Peeling** checkbox in the **Parameter** bar of the **TDR/TDT** tab.

10.7.5 File & Data Output

In the **File** pull-down menu at the top of the TDR toolbar, there are some shortcuts for file operation and data output.

The order **Save State...** is used to save the current state and calibration data as a **.CSA** file, and **Recall State...** is used to restore them from the files.

The order **Save Trc Data...** is used to save the current trace data to **.CSV** file, and **Save SnP...** saves all available S parameters data as an **.SNP** file whose format depends on the DUT topology.

Screenshot... is used to save the screenshot as a **.PNG** file.

10.8 Eye Diagram Simulation

10.8.1 Overview

Eye diagrams are used to analyze the influence of the intersymbol interference and noise on transmission performance, which is an important tool for signal integrity analysis. The eye diagram simulation function, included with the TDR option, is built on a virtual digital signal generator and the frequency characteristics of the DUT. It simulates that a virtual input digital signal transmits through the DUT, and analyzes the output signal to get an eye diagram. This is different from the traditional way of using an oscilloscope to draw eye diagrams. There is no need to provide an external digital signal to the input port of the DUT. To simulate different input signals, change the stimulus settings in the eye diagram module.

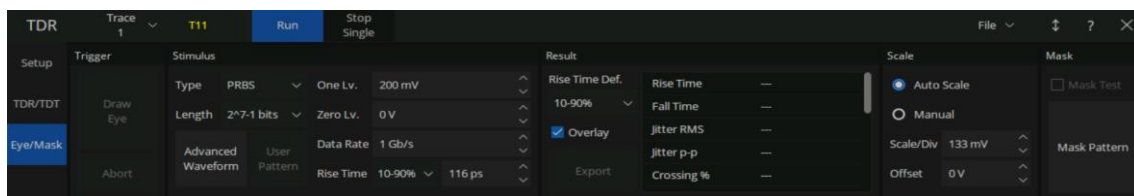

Figure 10-10-13 Eye/Mask Tab

The data analysis of eye diagrams in the option will try to get the numerical characteristics of the diagram and mark them on the diagram if required, which is designed to help the users obtain the key information quickly.

The jitter injection and statistical eye diagram function are provided to analyze the influence of the jitter in the input signal on the transmission performance.

The mask test on the eye diagram and preinstalled mask patterns are a convenient method of estimating whether the eye diagram meets the design requirements.

To start an eye diagram simulation after completing the simulation settings, click the **Draw Eye** button in the **Trigger** box of the **Eye/Mask** tab.

10.8.2 Stimulus Bit Pattern

There are 3 bit pattern types to choose in the option: Pseudo-Random Binary Sequence (PRBS), K28.5 comma code, and the user's bit pattern.

For more information about PRBS, refer to the section [Bit Pattern Length](#). K28.5 comma code is defined in an industry-standard developed by IBM which includes comma (control) characters. The user's bit pattern is imported from the user-defined files. The introduces of the bit pattern types in the table as follow:

Type	Bit Pattern Length	Generator
PRBS	Depends on the users, limited in 2^n-1 , $n = 3,5,7,9,11,13,15$	Generated by a virtual PRBS generator
K28.5	20	"00111110101100000101" (20 bits)
User	limited between 2 and 8192	Imported from a user-defined file

10.8.2.1 Bit Pattern Type

To change the input bit pattern types, click the **Type** pull-down menu in the **Stimulus** box of the **Eye/Mask** tab.

The option **Statistical** in the menu is used to switch on the statistical eye diagram mode, which cannot change the bit pattern types for the normal eye diagram simulation.

10.8.2.2 Bit Pattern Length

The bit pattern length of K28.5 code is 20 bits, and that of the user pattern depends on the text in the file. Only the length of PRBS can be changed in the eye diagram simulation module by clicking the **Length** pull-down menu in the **Stimulus** box.

A set of Linear Feedback Shift Register (LFSR) is simulated to generate virtual PRBS, whose maximum period is selected to equal the bit pattern length. The maximum of the period of PRBS, generated in a set of LFSR of n level, is 2^n-1 . In the other words, in ideal conditions, the sequence will iterate all possible binary numbers of n bits. The initial condition of the LFSR is random, PRBS generated becomes random to find the worst bit pattern of n bits for transmission performance. Eye diagram simulation always includes all n -bit input patterns to show the worst transmission performance of DUT, if PRBS is set as the input signals. So it's recommended to use PRBS as a bit pattern to draw eye diagrams.

The bit pattern length of PRBS is limited in 2^n-1 , and $n = 3, 5, 7, 9, 11, 13, 15$. That means the bit pattern will be generated by LFSR of n level, to include the worst condition as far as possible. The larger length is selected, the degree of the simulation perfection for intersymbol interference becomes better, but running time becomes longer.

10.8.2.3 User Pattern

If the eye diagram is required to simulate the specific bit pattern as the input signal, select the option **USER** in the **Type** pull-down menu, and click the **User Pattern** button to open the **Bit pattern Editor** dialog to set the user-defined pattern. In the dialog, you can load .txt files to import the text as the bit pattern and edit the bit pattern in the textbox. Close the dialog after loading or saving the bit pattern file, the pattern will be used for the next eye diagram simulation.

The text file to load must contain 0 and 1, but any other characters; and the length of text must be between 2 and 8192.

10.8.3 Stimulus Signal Setup

10.8.3.1 Logic Level

To change the logic level of the input signal, set the value in the **One Lv.** or **Zero Lv.** textbox in the **Stimulus** box.

10.8.3.2 Data Rate

The data rate of the signal is the number of bits transmitted per second, which reflects the base frequency of the signal. Considering the lowpass characteristics of transmission systems in reality, the transmission becomes bad with a large data rate, and the signal integrity analysis becomes important.

To change the data rate of the input signal, set the value in the **Data Rate** textbox in the **Stimulus** box.

10.8.3.3 Rise Time

The rise time of the signal reflects the steepness of the transition edge. The smaller rise time means the higher degree of steepness, the larger proportion of high-frequency parts, and the more serious high-frequency losses can be during transmission. It's effective to widen the eye by reducing the rise time properly. But too small a rise time leads to ringing phenomena at the logic level of the output signal, resulting in the decrease of the eye height.

To change the rise time type or value of the input signal, operate the **Rise Time** pull-down menu or textbox in the **Stimulus** box.

10.8.4 Eye Diagram Analysis

During the eye diagram simulation, the option analyzes the eye diagram automatically and try to get the numerical characteristics as follow: **Rise Time, Fall Time, Jitter, Crossing Percent, Opening Factor, The Ratio of Signal to Noise, Duty Cycle Distortion, Level One, Level Zero, Level Mean, Amplitude, Height, Width.** And **Rise Time, Fall Time, Jitter (peak-peak value), Amplitude, Height, Width** are allowed to be marked on the eye diagram to conveniently obtain the characteristics of the eye diagram.

10.8.4.1 Analysis Result Overlay

To switch on or off the data analysis markers on the diagram, click the **Overlay** checkbox in the **Result** bar.

10.8.4.2 Rise Time in Data Analysis

To change the rise time type for data analysis of eye diagrams, click the **Rise Time Def.** pull-down menu in the **Result** bar.

10.8.5 Eye Diagram Scale Management

By default, the eye diagram is displayed in the automatic scale settings, which show the details as clearly as possible. They can also be manually changed.

The scale settings in the vertical axis can be changed manually. But those in the horizontal axis depend on the data rate of the input signal, which can't be changed after the simulation starts.

To switch to a scale setting mode, click the **Auto Scale** or **Manual** radio button in the **Scale/Mask** bar.

To change the scale or offset values in **Manual** scale mode, set the value in the **Scale/Div** or **Offset** textbox. The **Offset** value here is the value that the center vertical scale line refers to.

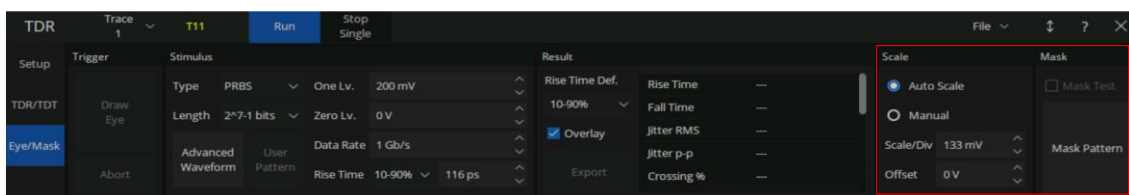

Figure 10-10-14 Eye/Mask setting

10.8.6 Mask Test for Eye Diagram

Mask patterns are some areas where the eye diagram is forbidden to pass, which transfer the design requirements of the transmission systems into the numerical characteristics of eye diagrams. They usually rule the tolerance of logic 0, 1 level and rise or fall time. If the eye diagram passes through the areas, the TDR option judges that the eye diagram can't meet the requirement, leading to the failure of the mask test. According to different communication standards, or at the different nodes in a communication system, different mask patterns should be applied. The first step to mask test is to select or design a suitable mask pattern based on the requirements.

To select or change the mask pattern applied, click the **Mask Pattern** button in the **Scale/Mask** bar to open the **Mask Pattern** dialog.

In the **File** tab of the dialog, preinstalled standard patterns or user-defined mask files (.MSK format) can be loaded. In the **Scale** tab, the **Margin** of the mask, start **Position** of a bit, **Delta** time of a bit, and **Logic Level** can be set in textboxes. In the **Edit** tab, the positions of vertices in the mask pattern can be changed by set values in the textboxes. Dragging the vertices in the left window also makes sense, but it's recommended to drag with a mouse connected to the VNA, because the points may be too close together for easy entry using touch operation.

Close the dialog after saving the modifications to a mask file, the new pattern will be applied to the next mask test.

To switch on or off the mask test, click the **Mask Test** checkbox in the **Scale/Mask** bar.

10.8.7 Jitter & Statistical Eye Diagram

Jitter is the transient deviation from the corresponding ideal position of a signal over successive trigger events. High jitter worsens the transmission performance. It's divided into the Deterministic Jitter (DJ) and the Random Jitter (RJ). RJ is generated by some unpredictable factors and is independent of the input bit patterns. The models for RJ usually have a Gaussian distribution, and the magnitudes are represented in root mean square (RMS) values. DJ is generated by some repeatable and predictable factors and usually has a finite magnitude value. The jitter related to the input bit patterns in DJ is called the Data Dependent Jitter (DDJ), while the other jitter in DJ is called the Periodic Jitter (PJ).

To change the settings of the jitter injection, click the **Advanced Waveform** button in the **Stimulus** box of the **Eye/Mask** tab, or click the buttons in the **Adv Waveform** bar of the **Setup** tab, to open the **Advanced Waveform** dialog. Click the **Jitter** button at the top of the dialog to switch to enter the jitter setting interface.

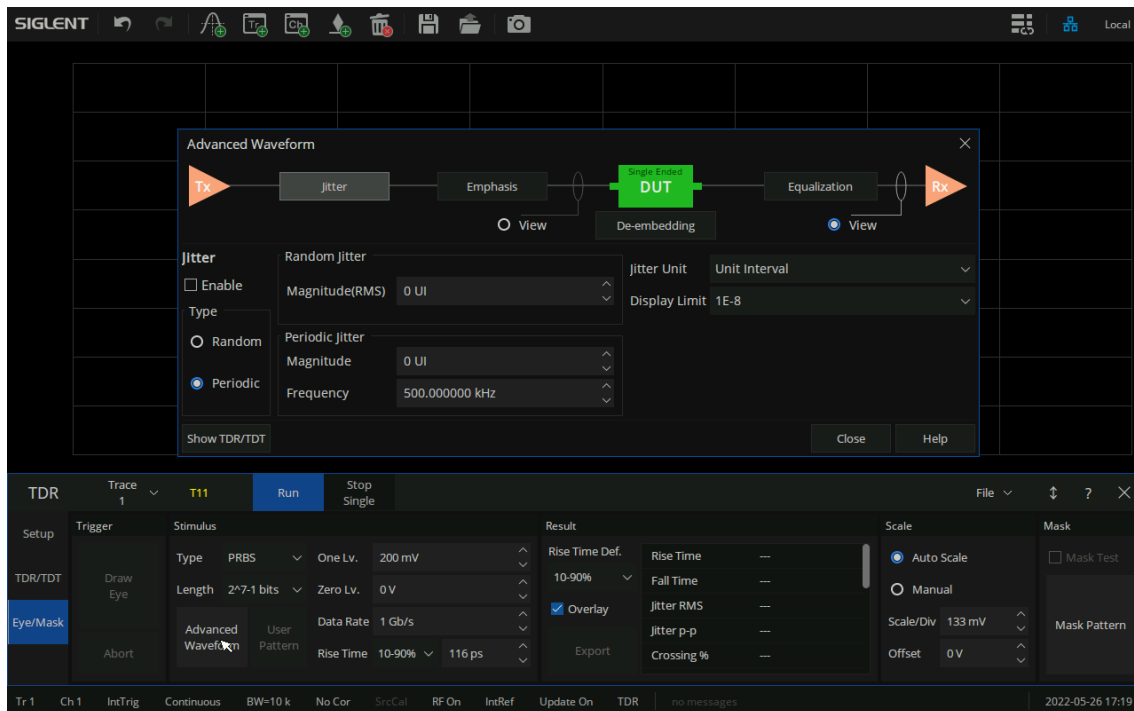

Figure 10-10-15 Eye jitter setting

To change the jitter type injected into the input signal, click the **Random** or **Periodic** ratio button in the **Type** box. To set the jitter parameters, set the values in the corresponding textboxes.

To select the jitter magnitude units, click the **Jitter Unit** pull-down menu. The unit UI means that the time difference value between the zero time of two adjacent transition edges in the signal, which is the default jitter magnitude unit.

To set the probability limit to display in the statistical eye diagram, click the **Display Limit** pull-down menu. If the probability of the signal appearing is lower than the display limit, it will be ignored and set to zero in the statistical eye diagrams.

To switch on the jitter injection for the next simulation after completing the jitter settings, click the **Enable** checkbox in the jitter setting interface. When the jitter injection function is switched on, the statistical eye diagram mode is enabled at the same time, the input bit pattern type is switched to **Statistical**.

To switch to the statistical eye diagram mode in manual, select the option **Statistical** in the **Type** pull-down menu in the **Stimulus** box. In the statistical mode, the input bit pattern is set to PRBS with a fixed length, so the statistical eye diagrams might be slightly different in several simulations of the same settings. The probabilities are represented by colors in the statistical eye diagrams: Warm colors indicate a large probability, red represents the largest ones; cold colors indicate a small probability, with deep blue representing the smallest values.

10.9 TDR Advanced Waveform Function

The Advanced waveform function is applied in both modules of the TDR option, TDR/ TDT analysis, and eye diagram simulation, which includes viewpoint setting, emphasis/ de-emphasis, de-embedding, and Continuous Time Linear Equalization (CTLE).

The corresponding settings in the **Advanced Waveform** dialog, which can be opened by clicking the buttons in the **Adv Waveform** bar of the **Setup** tab or the **Advanced Waveform** button in the **Stimulus** box of the **Eye/Mask** tab.

To switch the dialog to the interface for setting the specified function, click the corresponding button at the top of the dialog.

10.9.1 View point

To switch the viewpoint of the waveform to stimulus or responses, click the corresponding **View** ratio button at the top of the dialog.

Click the ratio button before the DUT icon, switch the viewpoint to stimulus, and the trigger mode is set to **Hold /Stop**, the transmission parameters show the stimulus signal only processed by emphasis /de-emphasis, which is the signal transmitted to the DUT. Setting the trigger mode to **Continuous /Run**, the viewpoint will be set to responses automatically.

Click the ratio button after the DUT icon, switch the viewpoint to responses, and set the trigger mode to **Continuous /Run**. The transmission parameters show the responses processed by emphasis /de-emphasis, DUT, and equalization.

10.9.2 Emphasis/De-emphasis

Because of the lowpass characteristics of transmission systems, the high-frequency components in the signal have higher losses than those at lower frequencies and the phenomenon becomes more serious as the transmission distance increases. The phenomenon is the main contributor to signal distortion during transmission. To control this distortion, the emphasis /de-emphasis technology is introduced to compensate for these additional losses by increasing the relative levels before the transmission. Transition edges in the time domain represent high-frequency components in the frequency domain. Emphasis /De-emphasis technology is designed to increase the level variation of the edges by adjusting the levels of the bits close to the edges. The parameters to adjust the levels of the first bit before or after the edges, and those for the two bits after the edges, are provided in the TDR option and are defined as Pre Cursor, Post 1 Cursor, Post 2 Cursor. By changing these

parameters, it's easy to simulate the influence of the different emphasis/de-emphasis strategies on the transmission performance in eye diagram simulations.

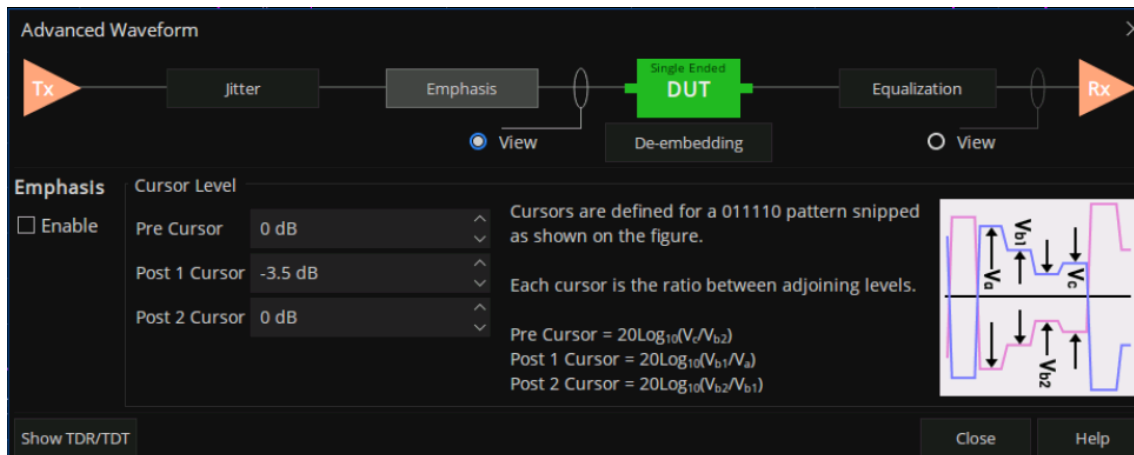

Figure 10-10-16 Emphasis setting

To change the parameters, set the value in the textbox in the **Emphasis** interface, and click the **Enable** checkbox to enable the function. The function is available in transmission parameters measurement and eye diagram simulations.

10.9.3 De-embedding

The TDR option provides a port de embedding function, which is the same as the port de embedding function in the fixture measurement function.

By clicking the Enable button on the left side of the De embedding tab, the TDR option port de embedding function main switch can be turned on/off.

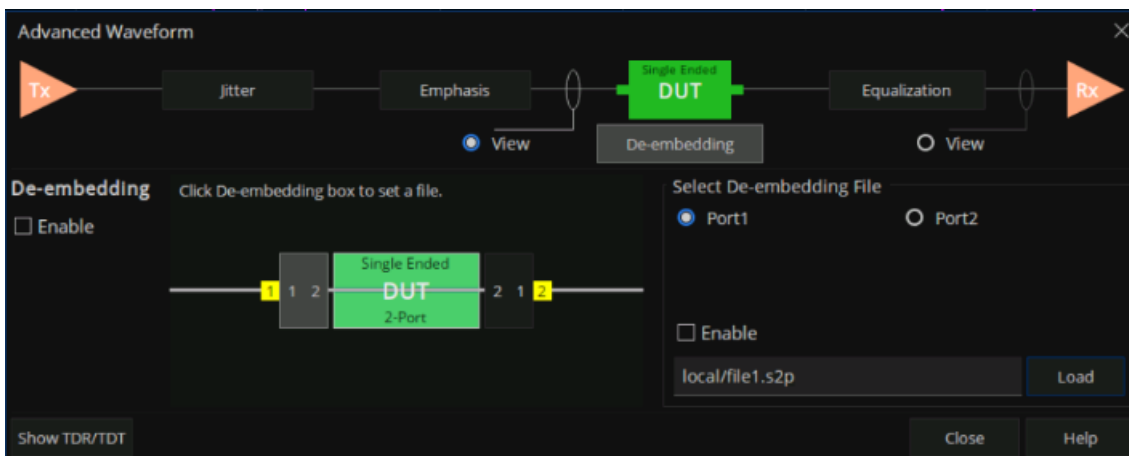

Figure 10-10-17

Then, select the port to be de embedded through the port in the image or the radio box on the right, click the Load button to load the SNP file that records the embedded network characteristics, and click the Enable checkbox on the right to enable the de embedding function on the selected port.

10.9.4 Equalization

To control the signal distortion resulting from the additional loss of high-frequency signal components, equalization technology is introduced to amplify the high-frequency parts properly after receiving the signal to balance the loss over various frequency spans. A high-pass filter and a continuous-time linear equalizer (CTLE) can be implemented. The CTLE simulation function in the TDR option allows the user to adjust the system function of the equalizer, to simulate the effect of the equalization on the transmission performance in eye diagram simulations.

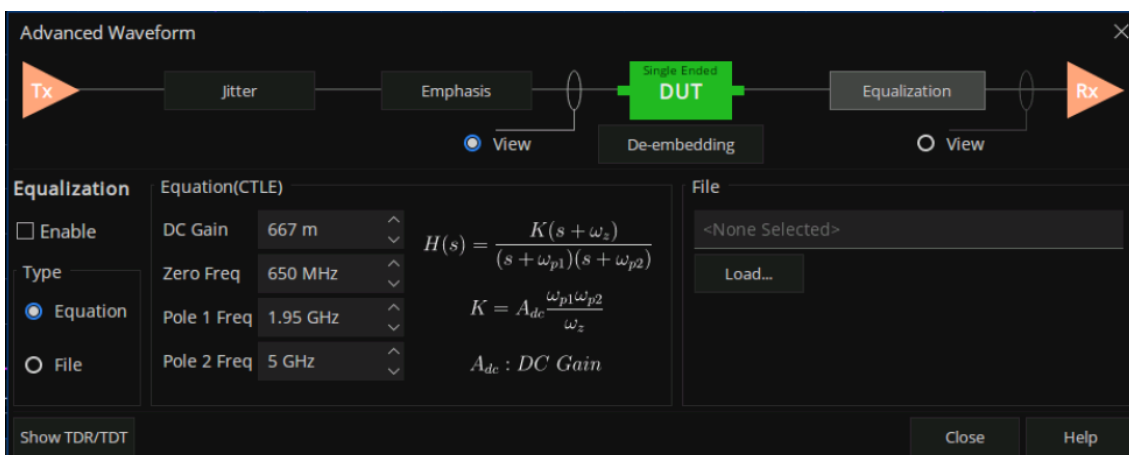

Figure 10-10-18 Equalization setting

The equalizer system function provided by the TDR option is as follows:; By adjusting the DC gain and zero pole position, the system function of the equalizer can be modified to simulate and evaluate different linear equalization strategies.

$$H(s) = \frac{K(s + \omega_z)}{(s + \omega_{p1})(s + \omega_{p2})}$$

The TDR option also provides a solution to describe the characteristics of the equalizer using the frequency response recorded in the CSV file: The TDR option simulates the equalizer using the frequency response recorded in the CSV file, The response value of the equalizer at the scanning frequency is obtained using amplitude phase linear interpolation method (when it exceeds the frequency range recorded in the file, the response value at the minimum frequency is taken when it is less than the minimum frequency, and the response value at two frequencies from low to high is taken when it is greater than the maximum frequency). The file format can refer to the following examples:

```
!SIGLENT Technologies
!VNA TDR-option Equalization File
# Hz dB
1000000000,-1.53E+01,-3.27E-01
2000000000,-1.52E+01,-7.34E+01
3000000000,-1.03E+01,-8.63E+01
4000000000,-9.88E+00,-1.00E+02
```

Notes:

1. The data format is indicated by the line starting with "#" (the data format is not case sensitive), with the first data in each line being the frequency, and the last two data representing the response value (complex) of the equalizer at that frequency. If the second data of the response value is omitted, the default value is zero. Support the following data formats to express frequency response. If the format description is omitted, the default is MA:

DB: The previous data represents the frequency response amplitude in logarithmic form, while the latter data represents the phase of the response in angular format.

MA: The previous data represents the amplitude of the frequency response, while the latter data represents the phase of the response (angle based).

RI: The previous data represents the real part of the response value, while the latter data represents the imaginary part of the response value.

2. The comment should start with '!' and ignore the comment content when reading.
3. The frequency is required to be arranged in ascending order. If the frequency of a row is lower than the previous row, the data in that row will be ignored.
4. The frequency response recorded in the file should include at least 2 frequency points, but not more than 10000 frequency points.

Set the relevant parameters through the fine-tuning box in the Equalization tab, or load a CSV file, select the radio box in the Type box on the left to describe the characteristics of the simulation equalizer, and select whether to enable the equalization function through the Enable check box on the left. This function is only effective for transmission parameter measurement and eye graph simulation.

10.10 Hot TDR

10.10.1 Overview

When conducting measurements, VNA usually assumes that the zero input response of the DUT is zero. That is to say, assuming that all signals received by the port receiver are triggered by test signals sent by the port transmitter to the DUT; The signal received by a receiver at a certain port should be equal to the sum of the signal vectors transmitted and reflected by the test signals sent by the transmitters at each port on the DUT to reach that port. According to the above assumption, VNA obtains the response generated by the test signal excitation at each port through measurement, and calculates the S parameter matrix of the DUT based on this.

If the zero input response of the DUT is not zero, when using VNA measurement, the signal received by the port receiver is equal to the vector sum of the response caused by the test signal sent by VNA and the zero input response of the device. Based on this, calculating the S parameter may result in significant errors. Therefore, such interference may reduce the accuracy of VNA measurement and can be suppressed in some cases.

If the zero input response amplitude of the DUT is small, the VNA power level can be appropriately increased without damaging the equipment and DUT, and the response amplitude caused by the VNA test signal can be increased, which can have a certain inhibitory effect on such interference.

If the zero input response of DUT obeys some statistical law, and the mean value in the time domain is zero (such as obeying Normal distribution); The average function can be enabled and the average frequency can be appropriately increased to suppress the impact of such interference on the measurement by averaging the responses measured multiple times.

If it is necessary to use VNA to measure the device in operation, and the tested device sends a digital signal with a known data rate to the test port during operation; In this case, the zero input signal of the DUT is not zero, and using the above method may not achieve good interference suppression effect. In frequency domain measurement, as interference signals are generally concentrated on a few frequencies, the impact on the entire frequency domain measurement may not be severe; In the TDR option, due to the superposition of interference signals in the time domain and actual input responses, the time-domain measurement results will be severely distorted.

Using the Hot TDR mode in the TDR option to measure such devices can suppress the impact of such interference on time-domain measurements. Due to the fact that VNA always scans several frequency points during frequency domain measurements to estimate the frequency characteristics of DUT within the testing frequency range; When the scanning frequency point coincides with the frequency of the interference signal, the test results at that frequency point will be affected by interference. In Hot TDR mode, VNA will search for scanning frequency settings to avoid interference signals based on their data rate, thereby eliminating the impact of interference signals on frequency domain measurement results.

10.10.2 Usage Guidelines

Before using the Hot TDR mode to measure equipment in operation, it is necessary to ensure that the test signal sent by VNA to the equipment does not cause equipment malfunction. Properly select the VNA power level to prevent excessive testing signal amplitude from damaging the tested equipment; Observe the changes in the reflected signal received by VNA during the process of reducing the power level. If there is a significant change in the reflected signal, the power level should be significantly lowered to prevent equipment failure.

When conducting measurements, if it is found that there are peaks in the frequency domain measurement results with constantly changing amplitudes at some frequencies, the time domain measurement results will fluctuate severely; It can be determined that the device's own signal output causes serious interference to time-domain measurement, and Hot TDR can be used to eliminate it.

On the right side of the Setup tab on the bottom toolbar of TDR, you can set the Hot TDR mode. Enter the data rate of the signal emitted by the device in the Data Rate fine-tuning box; If the data rate of the signal emitted by the device is unknown, an approximate value can be obtained using the cursor on the frequency measurement results. The data rate error should be less than $\pm 0.5\%$ to prevent failure in searching for scan frequencies that avoid interference.

Then, click on the "Avoidance Spurious" button and click "Yes" in the pop-up dialog box; VNA will check whether the current scan is affected by interference and search for scan frequency settings to avoid interference signals after confirming interference. If no interference is detected with the current scanning frequency, it will prompt that the interference signal has not been detected and continue to use the current scanning frequency setting for measurement. If a suitable scanning frequency is not found, it will prompt that a suitable scanning setting has not been found; This may be due to incorrect input data rates or excessive frequency components of interference signals, making it difficult to completely eliminate them. If the search is successful, the TDR option will enable the Hot TDR mode and use the scan frequency found for measurement. When the Hot TDR mode is enabled, the Avoid Spurious button will change to the Close Hot TDR button, which is used to turn off the Hot TDR mode; A mark  will appear on the right side of the button indicating that the Hot TDR mode is enabled.

After enabling the Hot TDR mode, due to changes in the original scanning frequency setting, recalibration may be necessary to obtain more accurate measurement results. In addition, after changing the DUT length or scanning frequency setting in Hot TDR mode, the original Hot TDR setting becomes invalid and may need to be reconfigured to eliminate the influence of interference signals.

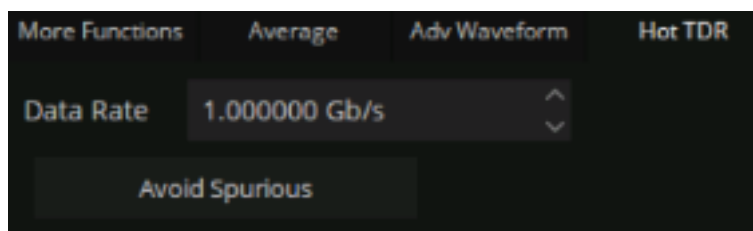

Figure 10-19 Hot TDR setting

11 Guide For the SA Option

11.1 Overview

Spectrum Analysis function is based on the VNA hardware, by adjusting the local oscillator signal and mirror suppression algorithm processing to obtain the signal spectrum, so as to achieve spectrum analysis function.

11.2 User Interface

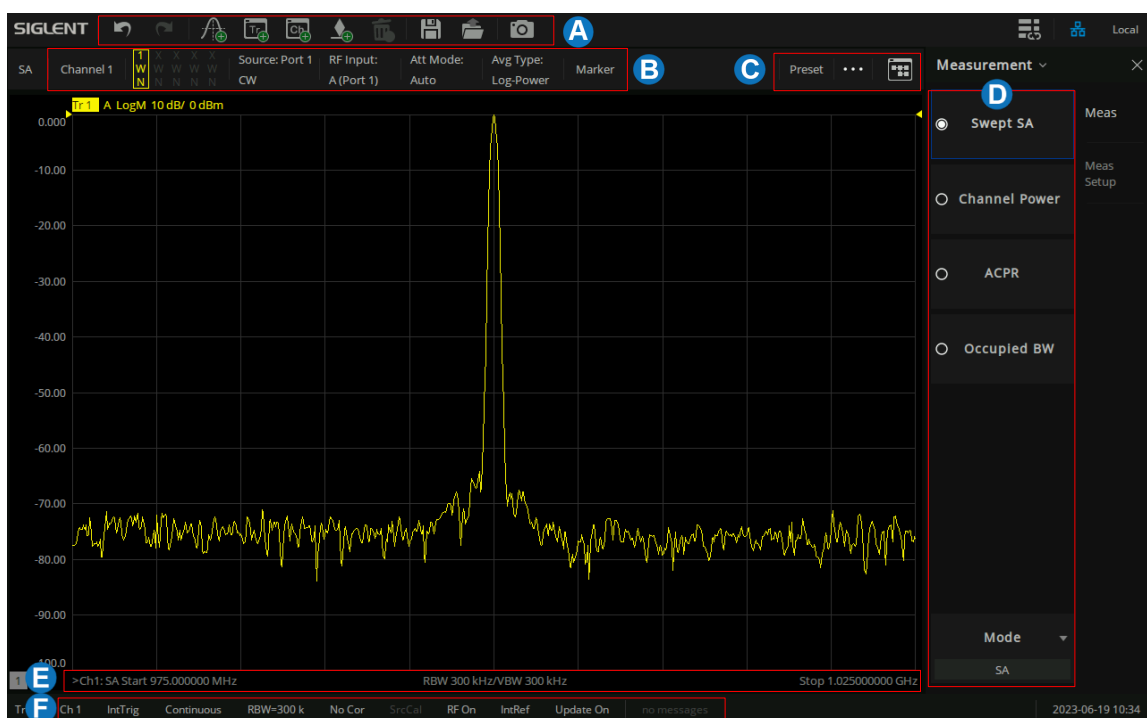

- A. Active Entry
- B. Indicate the main working state of state, the port of RF input, Attenuation mode, Average Type, Current Marker operation.
- C. Display the SA setting dialog box, SA parameter reset, SA processing flow chart
- D. SA Measurement items.
- E. Indicate and control the main sweep parameters, such as frequency, resolution.
- F. Status bar.

11.3 Create a Spectrum Analysis Channel

Press [Meas] > S-Params > Mode > SA, The SA channel selection dialog box will display after the SA measurement mode was selected. Select “Active Channel” (delete the existing measurement) or “New Channel” then click OK. A Spectrum Analysis measurement is displayed on the current channel or on a new channel and New Window.

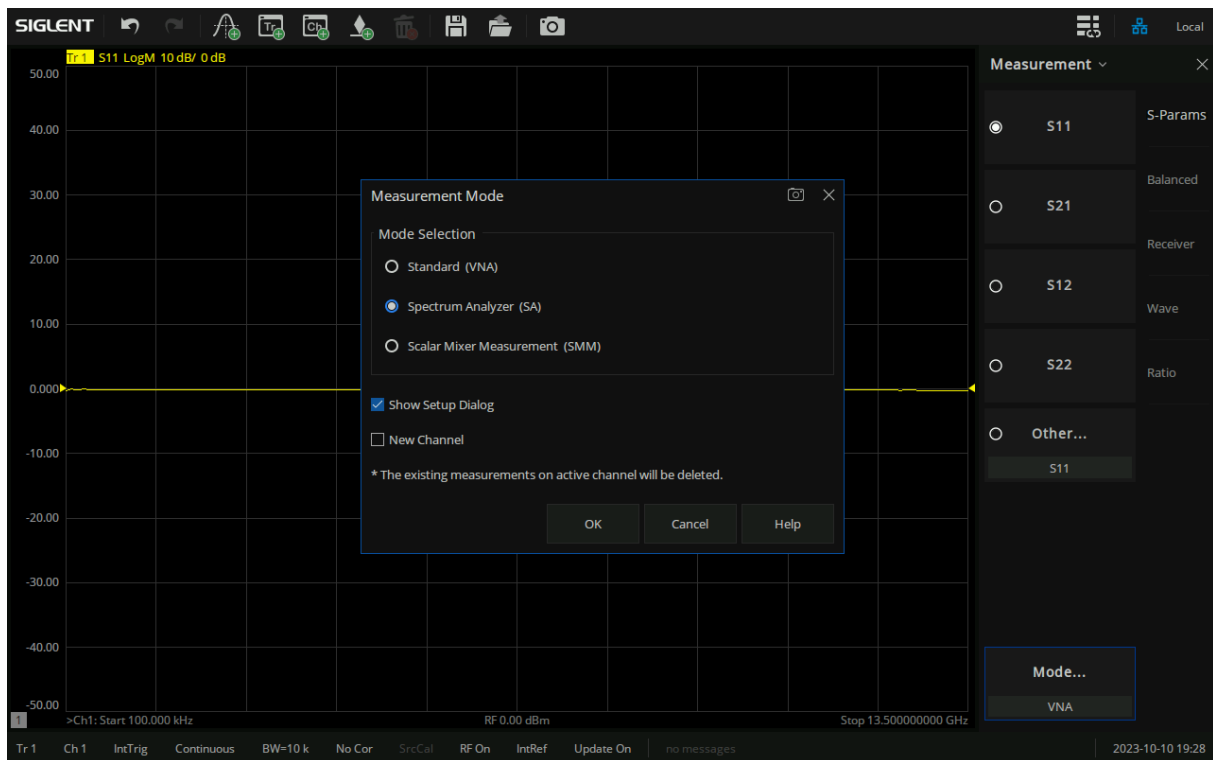

Figure 11-11-1 SA mode channel selection dialog box

In the interface of the SA channel selection dialog box, the “show setup dialog” check box is selected by default. when user clicks “OK”, a SA Setup dialog box will be displayed that can set related parameters. As figure shown below:

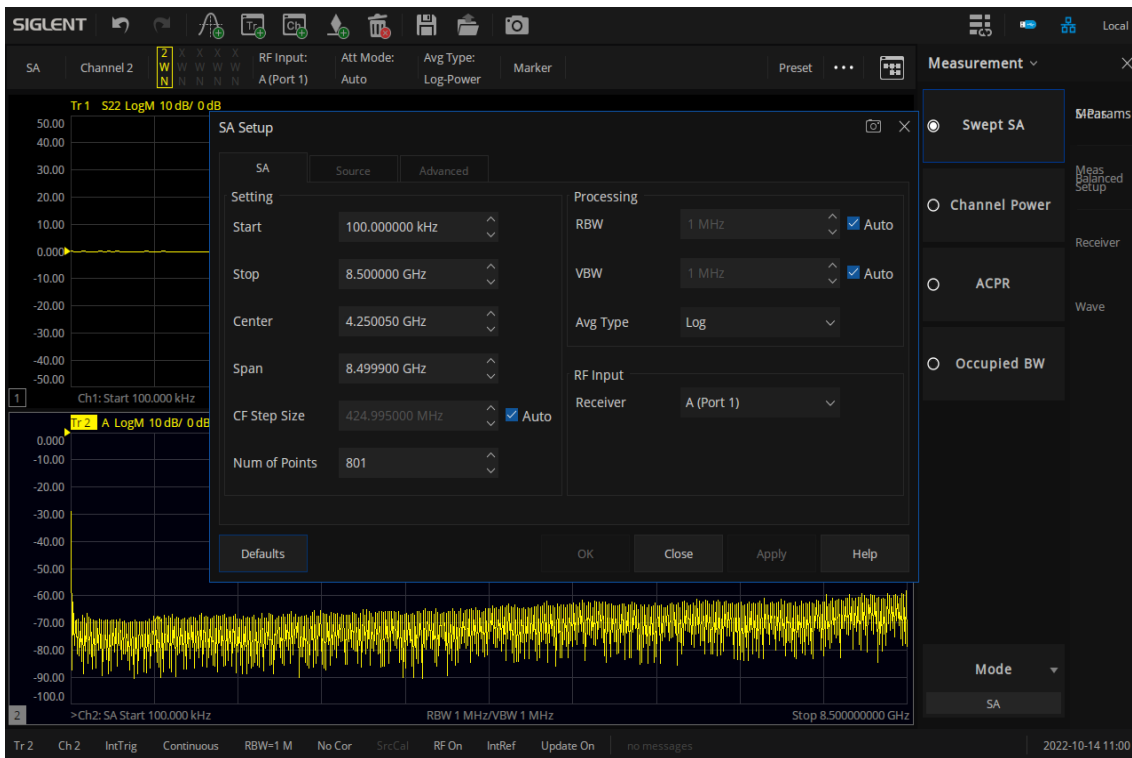

Figure 11-2 SA Setup dialog box

If the show Setup Dialog check box is deselected, the SA Setup dialog box will not be displayed when the SA function is enabled. If the user wants to modify the SA parameters, there are two ways to enter the SA Setup dialog box.

- Press **[Sweep] > Sweep > SA Setup...** to recall the SA Setup dialog box.
- Press **[Power] > Power > SA Setup...** to recall the SA Setup dialog box.

11.4 Spectrum Analyzer Settings

The SA Setup dialog box has three tabs: SA Tab, Source Tab and Advanced Tab.

The SA Tab configures the SA frequency range, CF step, sweep points, RBW, VBW, Average type and RF Input Receiver.

The Source Tab is the configuration of signal parameters when uses the internal source for spectrum analysis.

The Advanced Tab the configuration of relevant parameters related to signal processing.

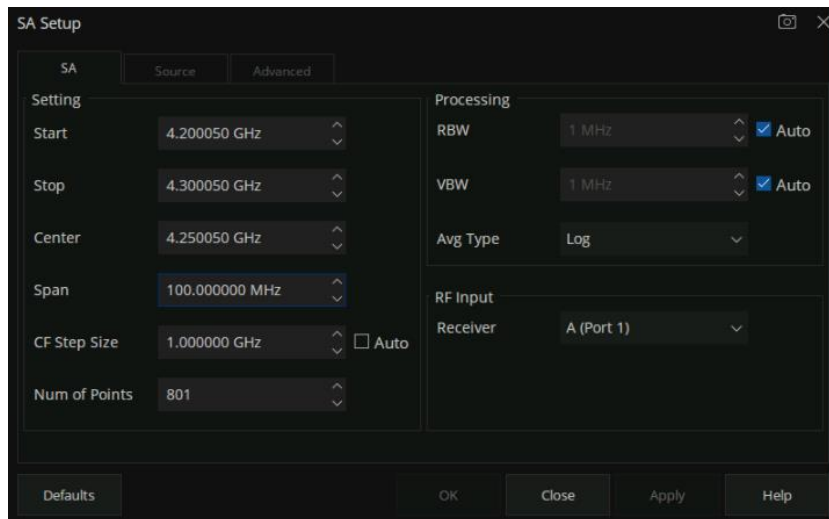

Figure 11-3 The SA Tab setting interface

11.4.1 SA Setting Tab

SA Tab Setting is mainly related to Spectrum analysis frequency setting, which can be set through the SA Setup dialog box or by pressing the [Freq] key on the front panel to enter the frequency setting menu, as the figure shown below. If the frequency is changed, the frequency sweep will restart.

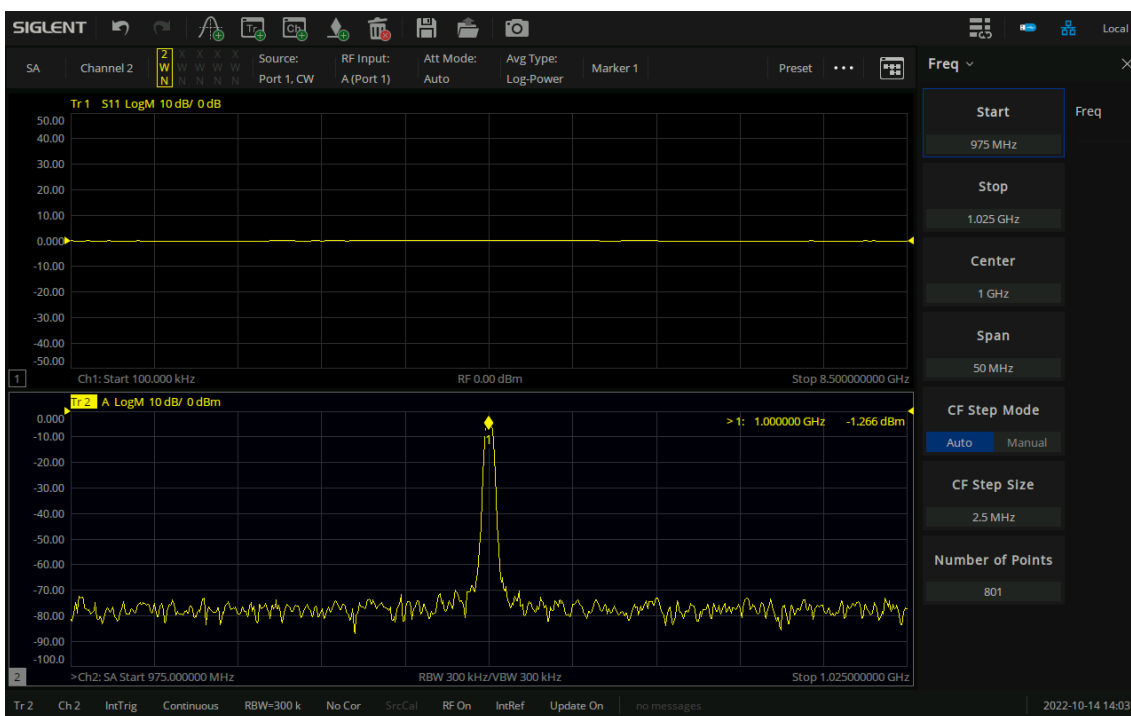

Figure 11-4 [Freq] key to set SA frequency parameters

The frequency range of a channel can be expressed by three parameters: Start Frequency, Center Frequency and Stop Frequency. If any of the parameters change, the others will be adjusted automatically in order to ensure the coupling relationship among them:

$$f_{center} = (f_{start} + f_{stop})/2, f_{span} = f_{stop} - f_{start}$$

11.4.1.1 Start Frequency

Set the start frequency of the Spectrum Analyzer. The start frequency and the stop frequency will display at the bottom of the grid respectively.

- The span and center frequency vary with the start frequency when the Span does not reach the minimum.

11.4.1.2 Stop Frequency

Set the stop frequency of the Spectrum Analyzer, the start frequency and the stop frequency will display at the bottom of the grid respectively.

- The span and center frequency vary with the stop frequency.

11.4.1.3 Center Frequency

Set the center frequency of the Spectrum Analyzer.

- Modifying the center frequency will modify both the start frequency and stop frequency when the span is constant (except when the start frequency or stop frequency reaches the boundary).

11.4.1.4 Span

Set the span of the Spectrum Analyzer. Any changes of the span will restart the sweep.

Pay attention to the following points when set the span:

- The start and stop frequency vary with the span when the center frequency is constant.
- The span can be set down to 100 Hz and up to the maximum bandwidth.
- Modifying the span may cause an automatic change in both CF Step Size and RBW if they are in Auto mode. Besides, the change of RBW may influence VBW (in Auto VBW mode).
- Variation in the Span, RBW or VBW would cause a change in the sweep time.

11.4.1.5 CF Step Size

Setting the value of CF step will change the direction key step of center frequency, start frequency, stop frequency and frequency offset.

When Auto mode is selected, the Center frequency step Size is 5% of the current span. That is, $f_{CF\ Step} = f_{span} * 5\%$. Each press of the ▲|▼ arrows on the front panel or click the up and down sign

of the SA Setup's center box. The center frequency $f_{CF Step}$ increases or decreases by the CF step size.

When Manual mode is selected, Users can customize the size of CF Step. Each press of the ▲|▼ arrows on the front panel or click the up and down sign of the SA Setup's center box. The center frequency $f_{CF Step}$ increases or decreases by the CF step size.

11.4.1.6 Num of Points

The number of sweep points represents the number of sweep and trace displayed points (201~10001)

More sweep points will improve the resolution of waveform, but also affect the minimum sweep time, and increase the time of data processing and remote access to data, and reduce the response rate.

11.4.2 SA Tab Processing setup

The SA processing setup is to config the signal's parameters. User can set the parameters via the SA Setup dialog, or by pressing [AvgBW] > BW to enter the spectrum analysis signal processing parameters setting menu, as the shown figure below.

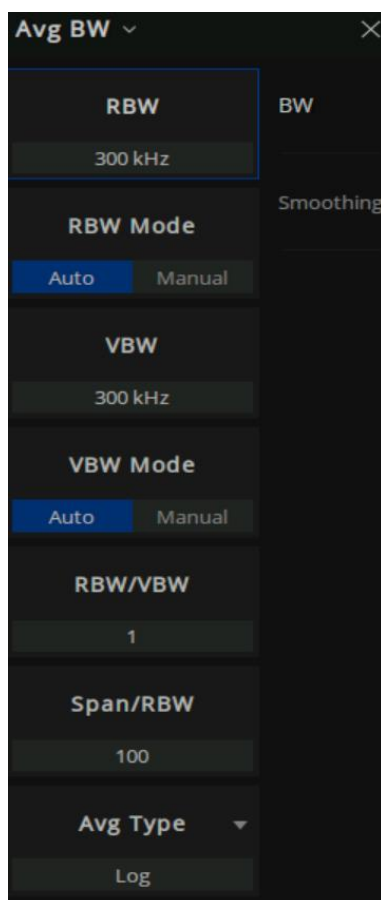

Figure 11-5 Spectrum analysis signal processing setup menu

11.4.2.1 RBW

Set the RBW (resolution bandwidth) in order to distinguish between signals which has frequency components that are near one another.

- Reducing the RBW will increase the frequency resolution. but lead to a longer sweep time (influenced by both RBW and VBW when the sweep time is in automatic mode).
- RBW varies with the Span/RBW setting in Auto RBW mode.

11.4.2.2 VBW

Set the video bandwidth in order to filter out the noise outside the video band.

- Reducing the VBW will smooth the trace and helps to highlight small signals from noise, but it will also increase the sweep time (Sweep Time is affected by a combination of RBW and VBW when it is in Auto mode).
- VBW varies with RBW when it is in Auto mode. While in Manual mode, VBW is not affected by RBW.

11.4.2.3 Averaging Type

Average type refers to the processing mode of intermediate frequency data in data detection and display detection, which affects the effect of trace average and detection average.

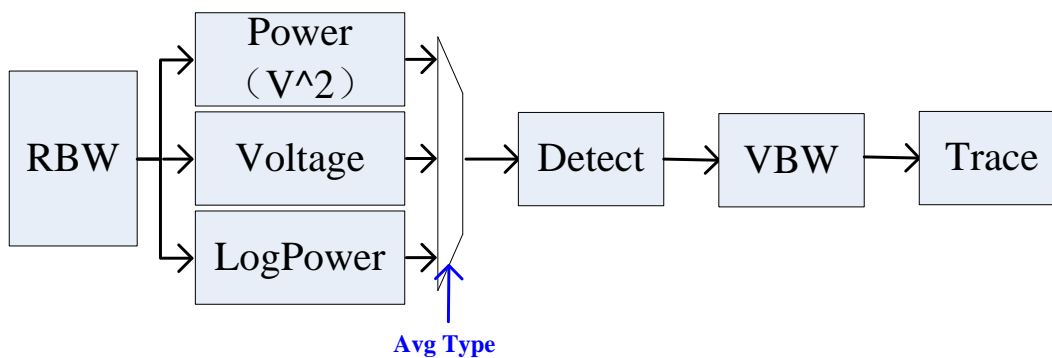

Figure 11-6 Flow chart of Average type

1. Log Power

Select the logarithmic (decibel) scale for all filtering and averaging processes. This scale is “Video” because it is the most common display and analysis scale for the video signal within analyzer. This scale is excellent for finding Sine/CW signals near noise.

2. Power Average

In this average type, all filtering and averaging processes work on the power (the square of the

magnitude) of the signal, instead of its log or envelope voltage. This scale is best for real-time power measurement of complex signals.

3. Voltage Average

In this Average type, all filtering and averaging processes work on the voltage of the envelope of the signal. This scale is suitable for observing rise and fall behavior of AM or pulse-modulated signals such as radar and TDMA transmitters.

11.4.2.4 RF Input Receiver

Select the receiver port for RF signal input.

11.4.3 Source Tab

The Source Tab of SA Setup is the configuration for internal sources as signal sources.

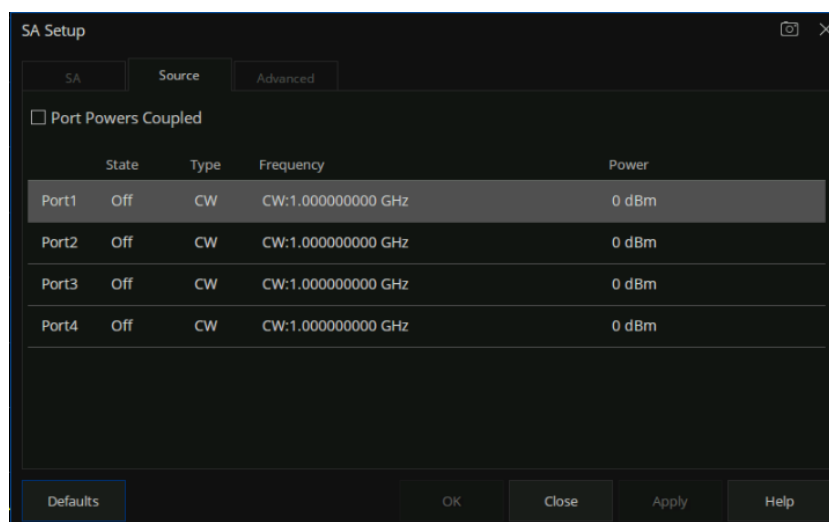

Figure 11-7 Source Tab

Port Powers Coupled (checked) the power levels are the same at each test port. Set power at any test port and all test ports change to the same power level.

SA Source Setup

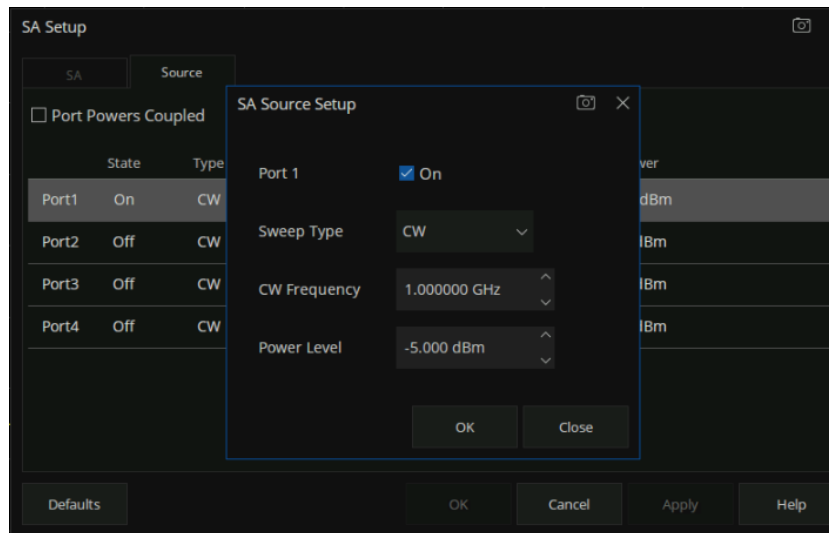

Figure 11-8 SA Source Setup

- State: If the “On” parameter is selected, the port source power is enabled
- Type (Sweep):
 1. CW: The source is set to a CW frequency.
 2. Linear Freq: The source is set to a power sweep.
 3. Power: The source is set to a power sweep.
 4. LinFreq + Power: The source is set to sweep from the Start to Stop frequency and power sweep.
- Frequency: Set the sweep Frequency of the source.
- Power: Set the power level of the source.

When the internal source is used for the Spectrum analysis signal sources, the sweep type, source frequency and the port power level of the source can also be set by pressing the [Power] key on the front panel to enter the port power setting menu. As the figure shown below:

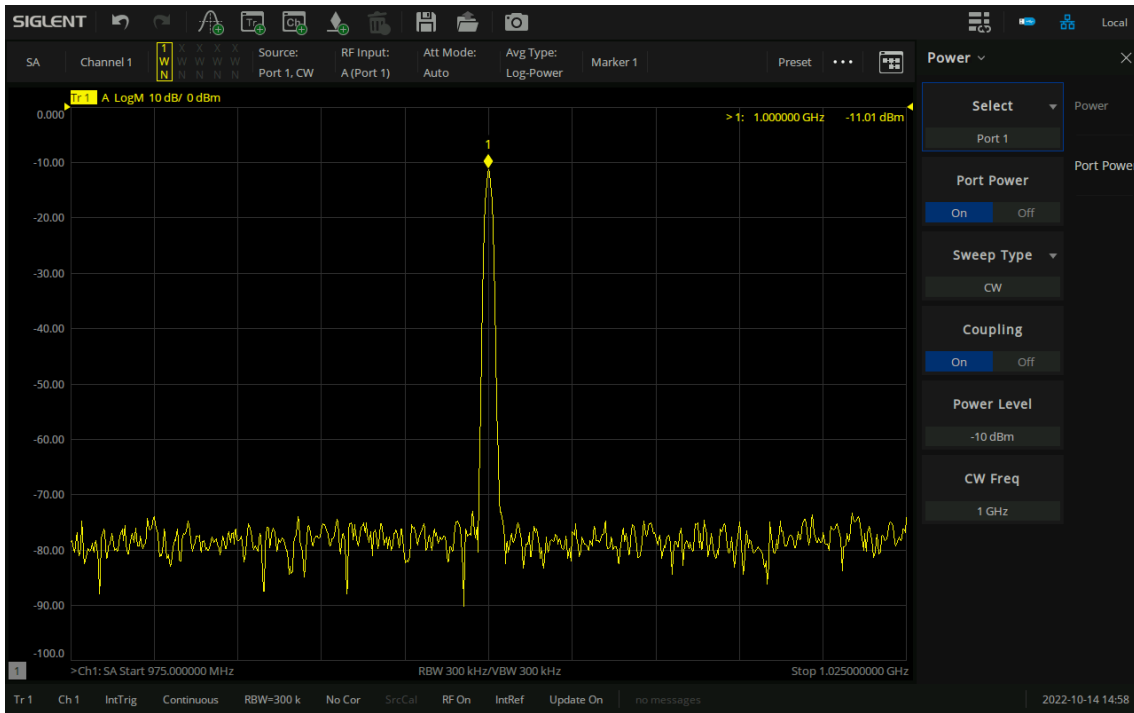

Figure 11-9 Press the [Power] key to enter the source’s setting menu

11.4.4 Advanced Tab

The Advanced Tab is the configuration of parameters related to signal processing for Spectrum analysis. Which can be set through the SA Setup dialog box or by pressing the [AvgBW] > BW on the front panel to enter the setting menu, as the figure shown below.

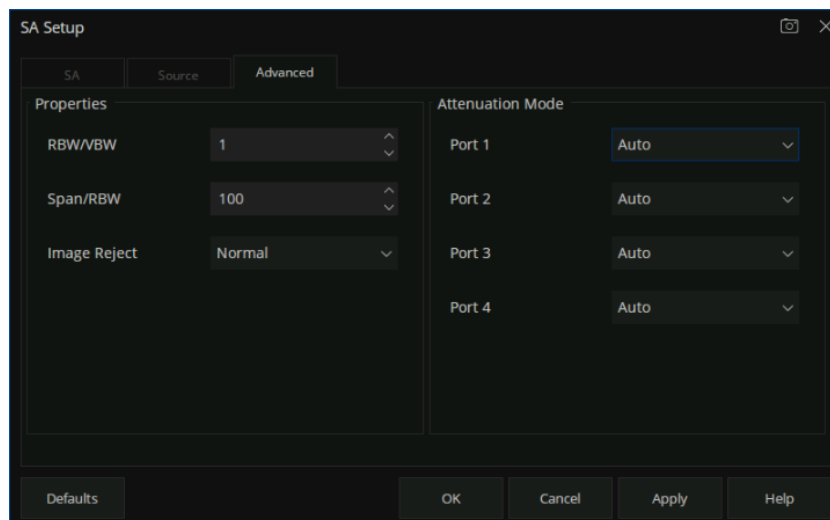

Figure 11-10 Advanced Tab setting menu

11.4.4.1 RBW/VBW

Sets the ratio of Resolution Bandwidth to Video Bandwidth when the Video Bandwidth is in Auto mode.

11.4.4.2 Span/RBW

Sets the ratio of Span to Resolution Bandwidth when the Resolution Bandwidth is in Auto mode.

11.4.4.3 Image Reject Type

The signal is mixed with the local oscillator to get an intermediate frequency signal, and the mixer may produce a mirrored frequency signal. Therefore, it is necessary to change the local oscillator or intermediate frequency to collect multiple groups of spectral data, and filter out the image through the image suppression algorithm.

None: Selects 1 acquisitions, and mirror suppression is not performed.

Min: Selects 3 acquisitions.

Normal: Selects 4 acquisitions.

Better: Selects 5 acquisitions.

Max: Selects 6 acquisitions.

Note: Only 3 sets of data can be acquisitions at most when the frequency point is below 40MHz.

11.4.4.4 Attenuation mode

Set the maximum power or voltage that can be currently displayed in the trace window. The value is displayed at the upper left corner of the screen grid.

The reference level is an important parameter of the spectrum analyzer, which indicates the upper limit of the current dynamic range of the spectrum analyzer. When the energy of the signal to be measured exceeds the reference level, nonlinear distortion or even overload alarm may be generated. The user should understand the nature of the signal to be measured and choose the reference level carefully. The reference level is too large to ensure full utilization of the linear range of the ADC, nor too small to be higher than the noise of the ADC. By setting a suitable reference level, the best measurement results can be obtained while protecting the spectrometer.

According to the amplitude of the input signal, the user can set the RF front-end attenuation mode of the response, which is to avoid the display distortion when the input signal is large and reduce the noise when the input signal is small.

Input attenuation can be set up to Auto, Low Noise and Standard mode.

- **Auto:** The attenuation value is automatically adjusted according to the state of preamplifier and the current reference level.

- **Low noise:** The minimum attenuation mode, the average noise level is lower.
- **Standard:** The maximum attenuation mode, the average noise level is higher.

11.4.5 Trace setup

Click the trace status area on the upper left corner of the interface, and the trace setting drop-down menu will pop up for trace setting operations.

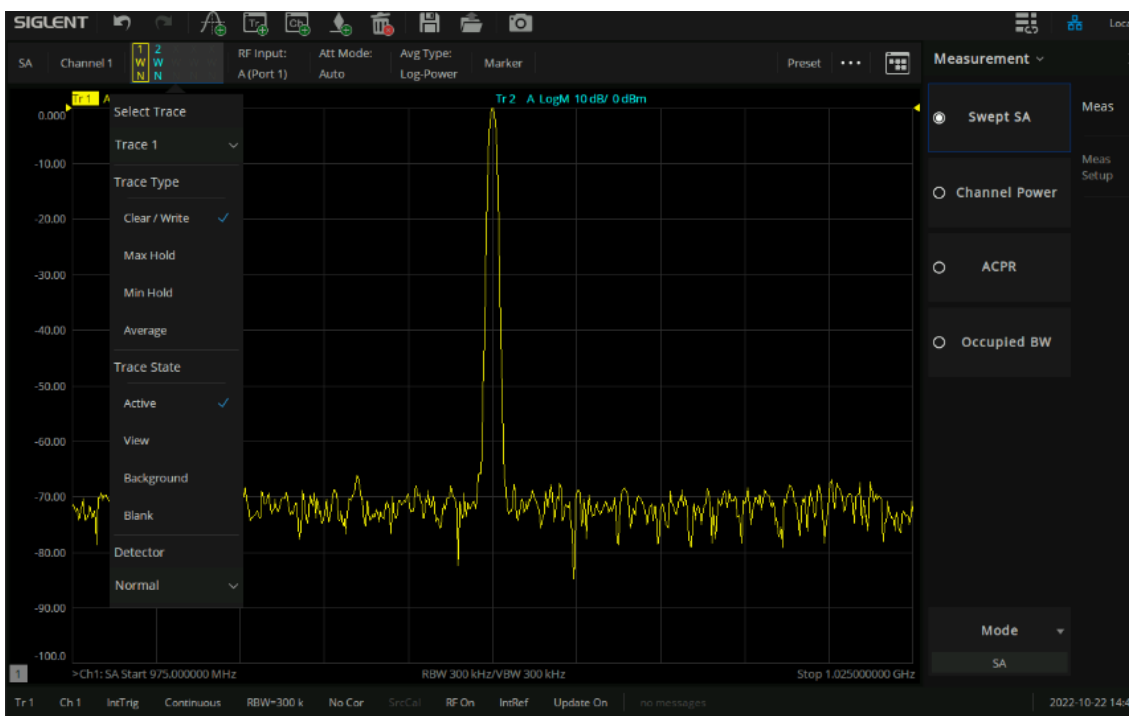

Figure 11-11 The trace Settings drop-down menu

11.4.5.1 Select Trace

Before operating on the Trace, the user needs to specify and only specify one trace at a time. The number of the selected trace will appear as selected in the status bar (with a yellow highlighted border).

11.4.5.2 Trace Type

There are four trace types: Clear/write, Max Hold, Min Hold, Average. Different trace types represent different processing methods of the trace data of a new frame on the historical frame data:

- **Clear/write** Erases any data previously stored in the selected trace, and display the data sampled in real-time of each point on the trace. The type identifier is “W”.
- **Max Hold** Retain the maximum level for each point of the selected trace. Update the data if a new maximum level is detected in successive sweeps. Max Hold is very effective when

measuring events that may take successive scans to measure accurately. Some common applications include FM Deviation, AM NRSC, and frequency hopping or drift. The type identifier is “M”.

- **Min Hold** Display the minimum value from multiple sweeps for each point of the trace and update the data if a new minimum is generated in successive sweeps. The type identifier is “m”.
- **Average** Set the averages times of the selected trace. The type identifier is “A”.

More averages can reduce the noise and the influence of other random signals, thus highlighting the stable signal characteristics. The larger the averages times is, the smoother the trace will be enabling averaging will take more time to collect the full spectral information because the analyzer needs to sweep the set average count. The displayed data is averaged in a first-in-first-out fashion.

11.4.5.3 Trace State

There are four trace states: active, view, blank, and background. Different trace states indicate the refresh and display states of traces:

- **Active:** Refreshed and displayed trace data.
- **View:** The trace data will not be refreshed, and the current latest trace will be displayed in a fixed frame.
- **Background:** Refreshed trace data but no display.
- **Blank:** Trace data is no longer refreshed or displayed

11.4.5.4 Detector

The analyzer displays the sweep signal on the screen in the form of a trace. For each trace point, the analyzer always captures all the data within a specific time interval and processes (Peak, Average, etc.) the data using the detector currently selected, then it displays the processed data (a single data point) on the screen.

Select an appropriate detector type according to the actual application in order to ensure the accuracy of the measurement

The available types are Positive Peak, Negative Peak, Sample, Normal and Average. The default is Normal.

- **Positive Peak:** For each trace point, Positive Peak detector displays the maximum value of data sampled within the corresponding time interval
- **Negative Peak:** For each trace point, Negative Peak detector displays the minimum value of data sampled within the corresponding time interval.
- **Sample:** For each trace point, Sample detector displays the transient level corresponding to the central time point of the corresponding time interval. This detector type is applicable to noise or noise-like signal.
- **Average:** For each trace point, Average detector displays the average value of data sampled within the corresponding time interval.
- **Normal:** Also known as normal detection or rosenfell detection. Using conventional detection traces, the trace data is paired in pairs, with odd points displaying the maximum value at the sampling points and even points displaying the minimum value at the sampling points. This can intuitively reflect the amplitude range of the signal (background noise), but due to implementation reasons, there may also be a certain signal frequency deviation

In practical implementation, conventional detection belongs to secondary detection, which uses two adjacent pairs (a group) of positive and negative peaks for comparison. If the actual signal appears at an even point position, in order to achieve the display effect of "odd point displays the maximum value in the sampling point, and even point displays the minimum value in the sampling point", the order of the data in that group will be reversed, resulting in frequency deviation.

User can manually select an appropriate detection type based on actual requirements and application scenarios to ensure measurement accuracy, or set the detection type to automatic.

11.5 Spectrum Analysis measurement

11.5.1 Marker → SA

During S parameter measurement, if the user wants to have a quick view of the specific frequency point's spectrum, spectrum analysis can be opened by means of Marker → SA. That is to create a new SA channel in full frequency span based on the S parameters, and a marker is created on the trace at the same frequency as the S parameter channel marker.

The same receiver that is used for the S parameter channel is used for the SA channel. For example, if a marker is opened in the S11 channel, a SA measurement is created using the receiver "A" of port1 after "Marker → SA".

How to open Marker → SA:

1. Make an S parameter measurement, such as S44, set the center frequency as 1GHz and Span as 50MHz. and mark the S44 trace by pressing the [Marker] key on the front panel;
2. Press **[Marker] > Marker Function > Marker → SA** to enable the SA function. You can view the frequency spectrum of 1GHz point of the S44, as figure shown below:

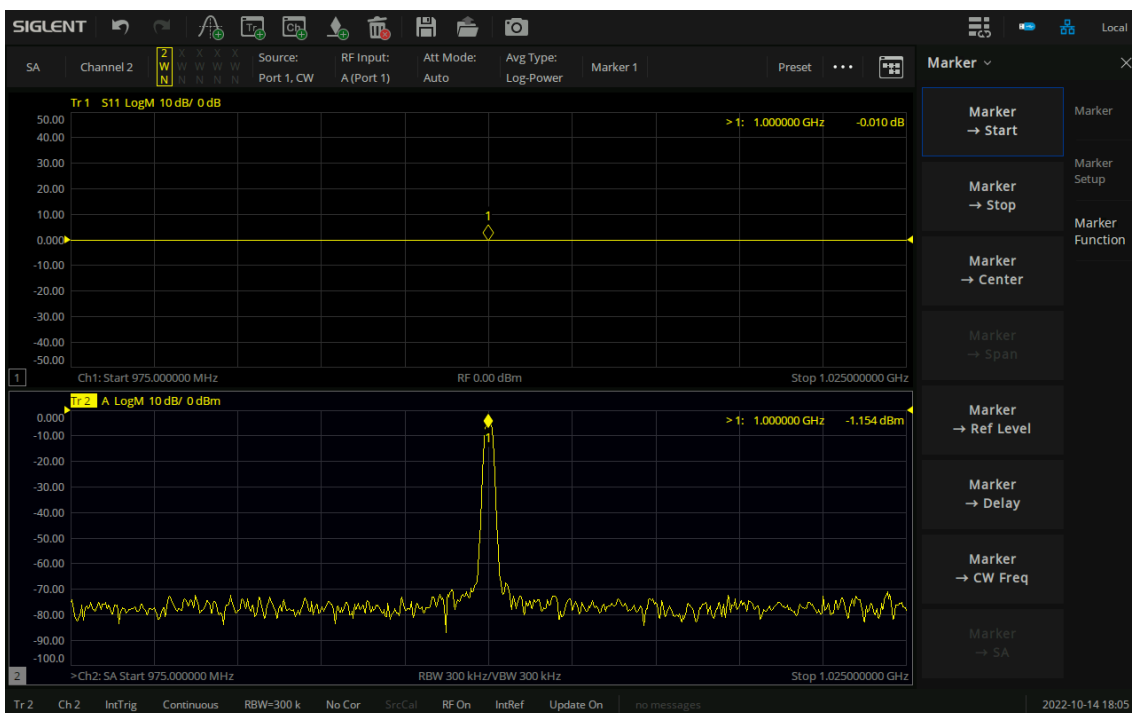

Figure 11-12 Marker → SA

Press **[Sweep] > Sweep > SA Setup...** can recall the SA Setup dialog box. If the user needs to modify the SA parameter settings.

11.5.2 Channel Power

Measure the power and power density within the specified channel bandwidth. When this function is enabled, the span and resolution bandwidth are automatically adjusted to smaller values. Select "Channel Power" and click "Meas Setup" to set the corresponding parameters. The two vertical lines on the trace perpendicular to the X-axis represent the integration bandwidth. The Y-axis value is set to the measured power value, and displays on the upper right corner.

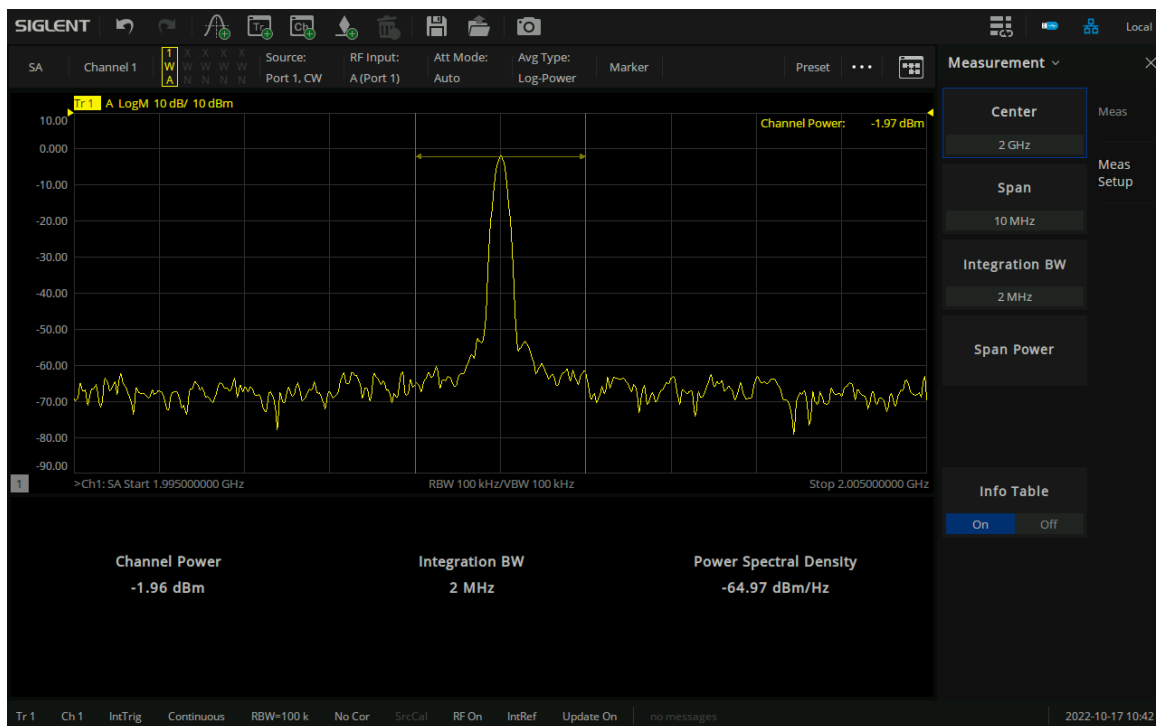

Figure 11-13 Channel Power measure

11.5.2.1 Integration BW

Set the frequency width of the channel to be tested and the power of the channel is the power integral within this bandwidth. You can use the numeric keys, knob or direction keys to modify this parameter.

11.5.2.2 Info Table

When the information table is “On”, click other menu options and the measurement result table will not be closed. When the status of the information table is “Off”, the measurement result information table will be closed

Channel power measurement results include: Channel power and power spectral density.

The measurement of the specified channel power is centered on the central frequency point of the channel, and the frequency Span of the test channel is adjusted. The channel power is the integral of this frequency span, and the bandwidth of the specified channel is called the integral bandwidth. The value of the integral bandwidth is related to Span but \leq Span.

- **Channel Power:** Power within the integration bandwidth.

$$\text{chPow} = \sum_{\text{start}}^{\text{stop}} \left(\frac{\text{watt}}{\text{rbw}} \right) * (\text{itgBW}/(\text{stop} - \text{start}))$$

chPow : Channel power, in watts

start, stop : The start and stop frequency of channel.

watt : Absolute power converted from sweep point data, in watts

rbw : resolution bandwidth

itgBW : integration bandwidth.

- **Power Spectral Density:** Power (in dBm/Hz) normalized to 1Hz within the integration bandwidth

$$\text{nspd} = \text{chPow}/\text{itgBW}$$

nspd : Power Spectral Density

itgBW : Integration bandwidth.

11.5.3 ACPR

Measure the power of the main channel and adjacent channels as well as the power difference between the main channel and each of the adjacent channels. When this function is enabled, the span and resolution bandwidth of the analyzer are adjusted to smaller values automatically. Select ACPR and click “Meas Setup” to set the corresponding parameters.

The main channel and the left and right adjacent channels are specified, the main channel is centered on the central frequency point, and the left and right adjacent channels are symmetric with respect to the main channel. Channel parameters can be changed by setting the bandwidth of the primary channel, the bandwidth of the neighboring channel, and the interval between the neighboring channel and the center point of the primary channel. The power of each channel is calculated by the same method as the channel power algorithm. The ratio of the power of the adjacent channel to the power of the main channel is the ratio of the power of the adjacent channel.

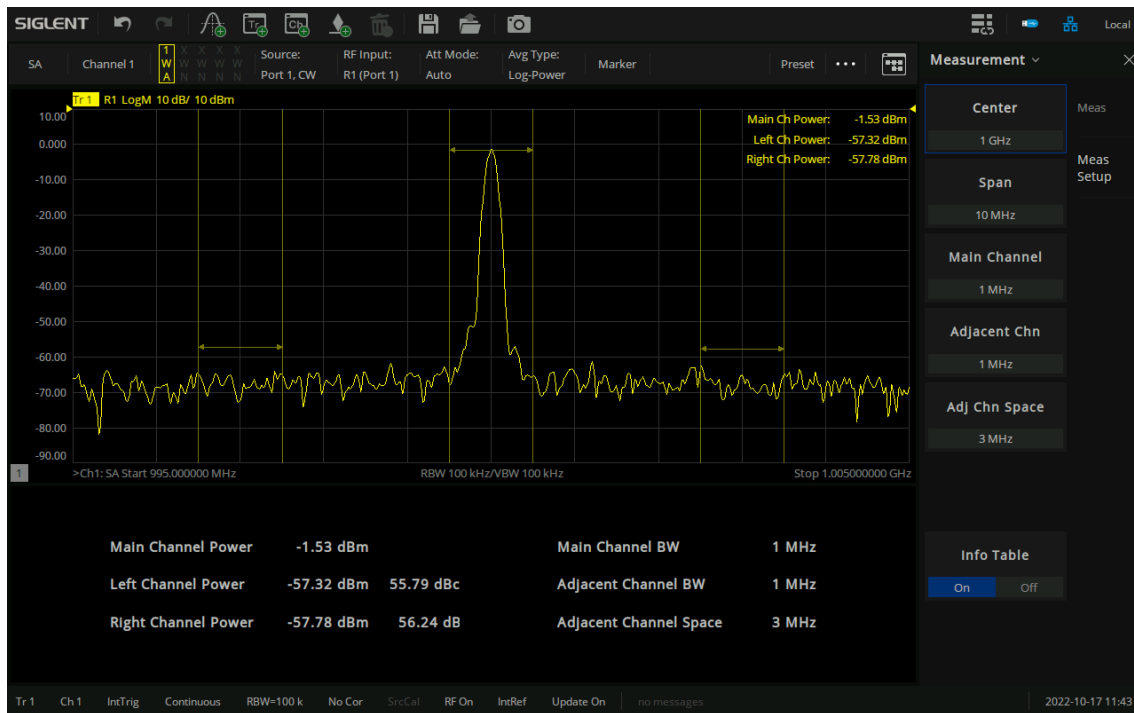

Figure 11-14 ACPR measurement

11.5.3.1 Main Channel

Set the bandwidth of the main channel, and its power is integrated within this bandwidth.

11.5.3.2 Adj Chn

Set the bandwidth of adjacent channels.

11.5.3.3 Adj Chn Space

Center frequency spacing between the main channel and neighboring channels. Adjusting the adjacent channel spacing will adjust the distance between the previous channel and the back channel and the main channel at the same time.

11.5.3.4 Info Table

When the information table is "On", click other menu options and the measurement result table will not be closed. When the status of the information table is "Off", the measurement result information table will be closed.

ACPR measurement results include: Main CH Power, Left channel power and Right channel power.

- Main CH Power: Displays the power within the bandwidth of the main power
- Left channel power : Displays the power of left channel and the power difference between the left channel and the main channel (in dBc)
- Right channel power: Display the power of the right channel and the power difference between the right channel and the main channel(in dBc)

11.5.4 Occupied BW

Integrates the power within the whole span and calculates the bandwidth occupied by this power according to the specified power ratio. The OBW function also indicates the difference (namely “Transmit Freq Error”) between the center frequency of the channel under measurement and the center frequency of the analyzer.

Select “Channel Power” and click “Meas Setup” to set the corresponding parameters. The two vertical lines on the trace perpendicular to the X-axis represent the occupancy span of the power percentage. The value on the Y-axis is the power occupying the bandwidth, and displays on the upper right corner.

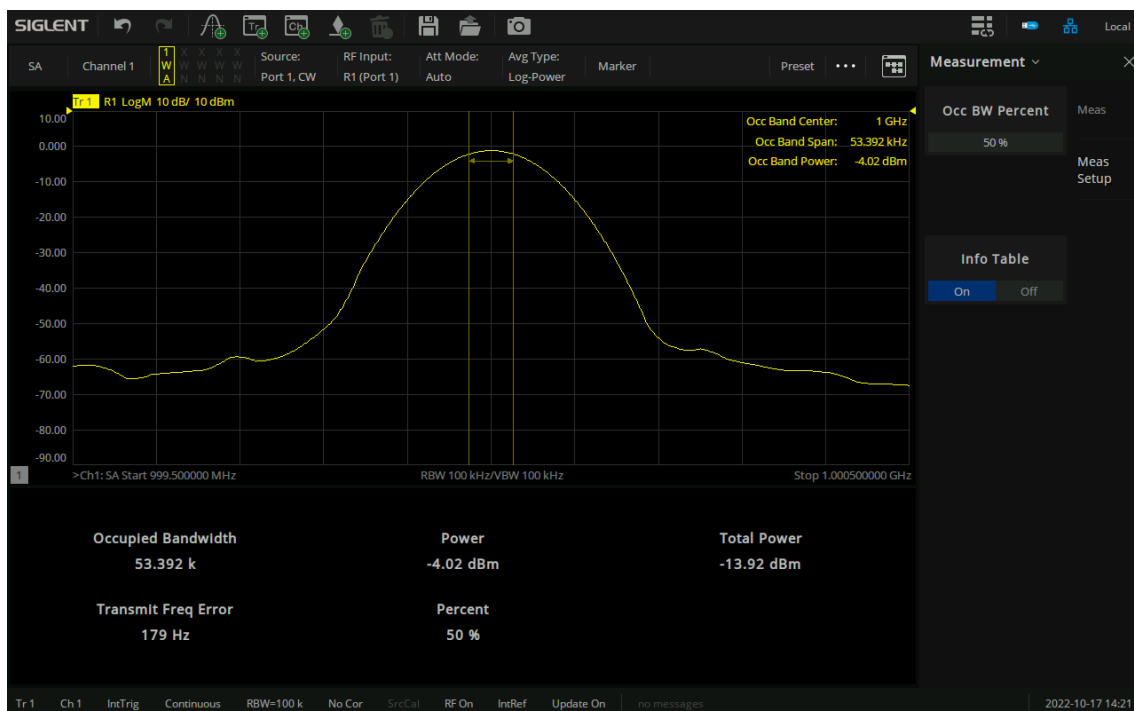

Figure 11-15 Occupied BW measurement

11.5.4.1 Occ BW Percent

Specifies the percentage of total power measured within occupied bandwidth for the current measurement.

11.5.4.2 Info Table

When the information table is “On”, click other menu options and the measurement result table will not be closed. When the status of the information table is “Off”, the measurement result information table will be closed.

- Occupied Bandwidth: Integrates the power within the whole span and then calculates the bandwidth occupied by the power according to the specified power ratio.
- Power: the power according to the specified power ratio.
- Total Power: the whole span power.
- Transmit Freq Error: The difference between the center frequency of the channel and the center frequency of the analyzer.

11.5.5 TOI

11.5.5.1 TOI Overview

TOI is the function that is automatic measurement of IP3 (Third order Intercept Point), including the power of fundamental wave and the Third order in the power, and calculate the adjustable Intercept Point. After entering the SA mode, select the TOI function, then the measurement is automatically performed without setting parameters.

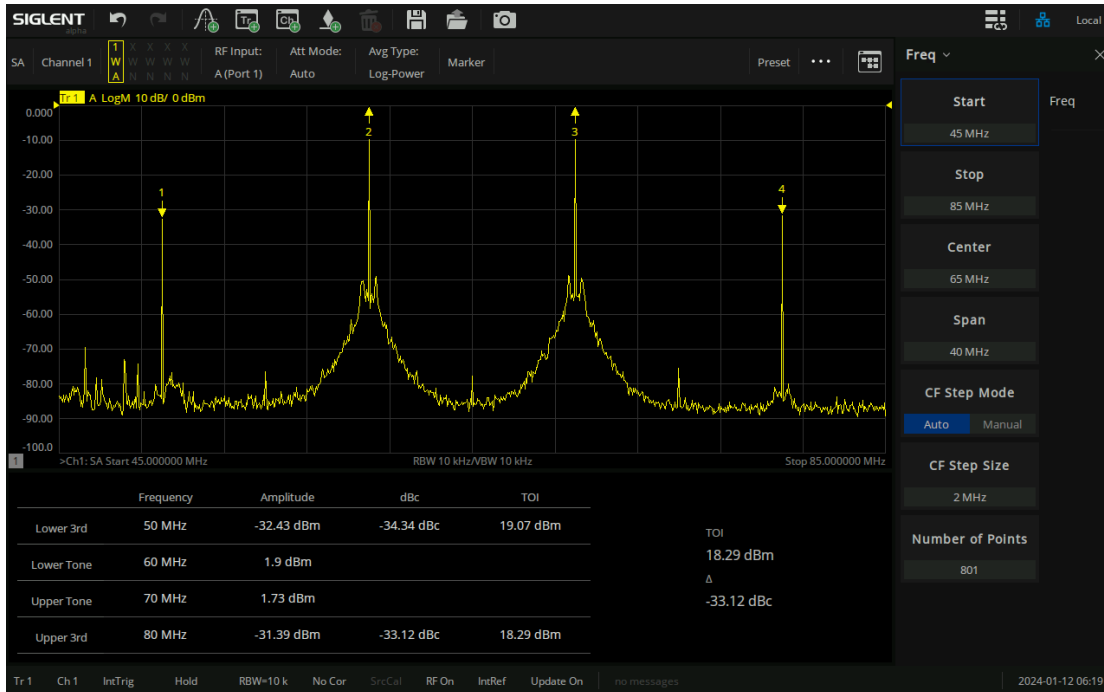

Figure 11-16 TOI measurement

TOI searches for positive peaks within the sweeping range, and takes the first two peaks as the fundamental frequency and marks them as f2 and f3, corresponding to the amplitude p2 and p3. If no peak value meets the conditions, the test is considered to have failed. The message "Two peaks are not found." is displayed, which can be found in the message bar. If two peaks are found, the Frequency point of the intermodulation component $f1 = 2 * f2 - F3$, $f4 = 2 * F3 - F2$. If a point in f1 and f4 exceeds the scanning range, the prompt "Frequency of toi is out of range." will be displayed, and this information can be found in the message bar. If f1 and f4 are in the sweeping range, the corresponding power is denoted as p3 and p4, and the crossover interception point is calculated according to the above information:

$$IP3_Lower = (p2 - p1)/2 + p2$$

$$IP3_Upper = (p3 - p4)/2 + p3$$

11.5.5.2 TOI Info Table

When the information table is "On", click other menu options, the result information table will not close, Otherwise close the result information table. If all the information of the third-order crossover is successfully calculated, the result information table displays the calculation result of the third-order crossover. Otherwise, " – " is displayed. The result information table contains the following contents:

- Lower 3rd: Low frequency component of TOI.

- Lower Tone: The lower frequency fundamental signal of the input signal.
- Upper Tone: The Upper frequency fundamental signal of the input signal.
- Upper 3rd: Upper frequency component of TOI.
- Frequency: The frequency of each item in the TOI calculation.
- Amplitude:
- dBc: Decibels of the ratio of the intermodulation component to the power of the fundamental frequency signal
- TOI: Third-Order Intercept Point

After the information of the TOI is successfully calculated, the smaller of the two TOI points and the corresponding dBc is displayed separately.

11.5.6 CNR

11.5.6.1 CNR Overview

Measure the power of the carrier and noise of the specified bandwidth and their ratio. Select CNR measure and click **Meas Setup** menu to set the corresponding parameters.

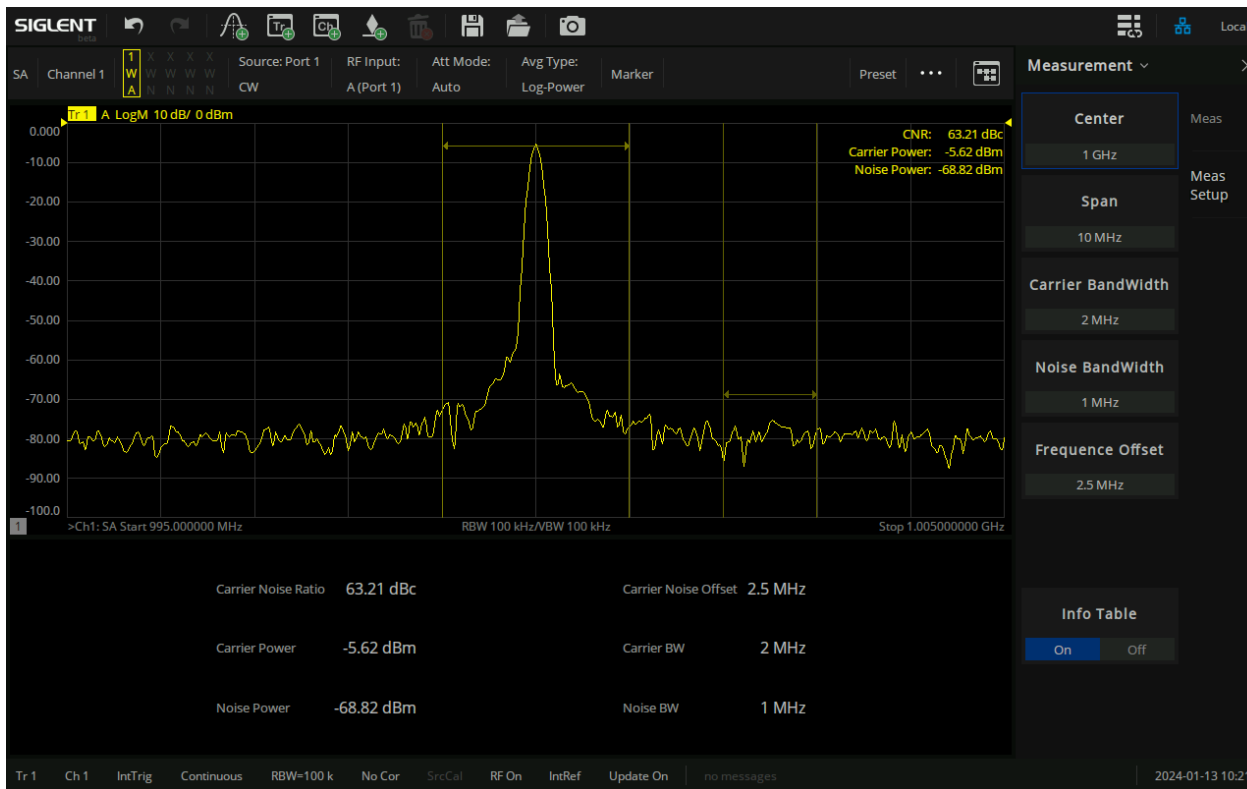

Figure 11-17 CNR measurement

Carrier BandWidth: Set the bandwidth of the carrier to be measured. Carrier bandwidth is correlated with Span, Noise bandwidth and Frequency offset.

Noise BandWidth: Set the bandwidth of the noise to be measured. Noise bandwidth is correlated with Span, Carrier bandwidth and Frequency offset.

Frequency Offset: Set the difference between carrier center frequency and noise center frequency. Frequency offset is correlated with Span, Carrier bandwidth and Noise bandwidth.

11.5.6.2 CNR Info Table

When the information table is "On", click other menu options, the result information table will not close, Otherwise close the result information table.

- Carrier Power: the total power of the carrier bandwidth.
- Noise Power: the total power of the selected noise bandwidth.
- Carrier Noise Ratio: the ratio of Carrier Power to Noise Power.

11.5.7 Spectrum Monitor

11.5.7.1 Spectrum Monitor Overview

Display the power of the swept spectrum as an intensity color map commonly referred to as a waterfall chart. Select Spectrum Monitor measure and click **Meas Setup** menu to set the corresponding parameters.

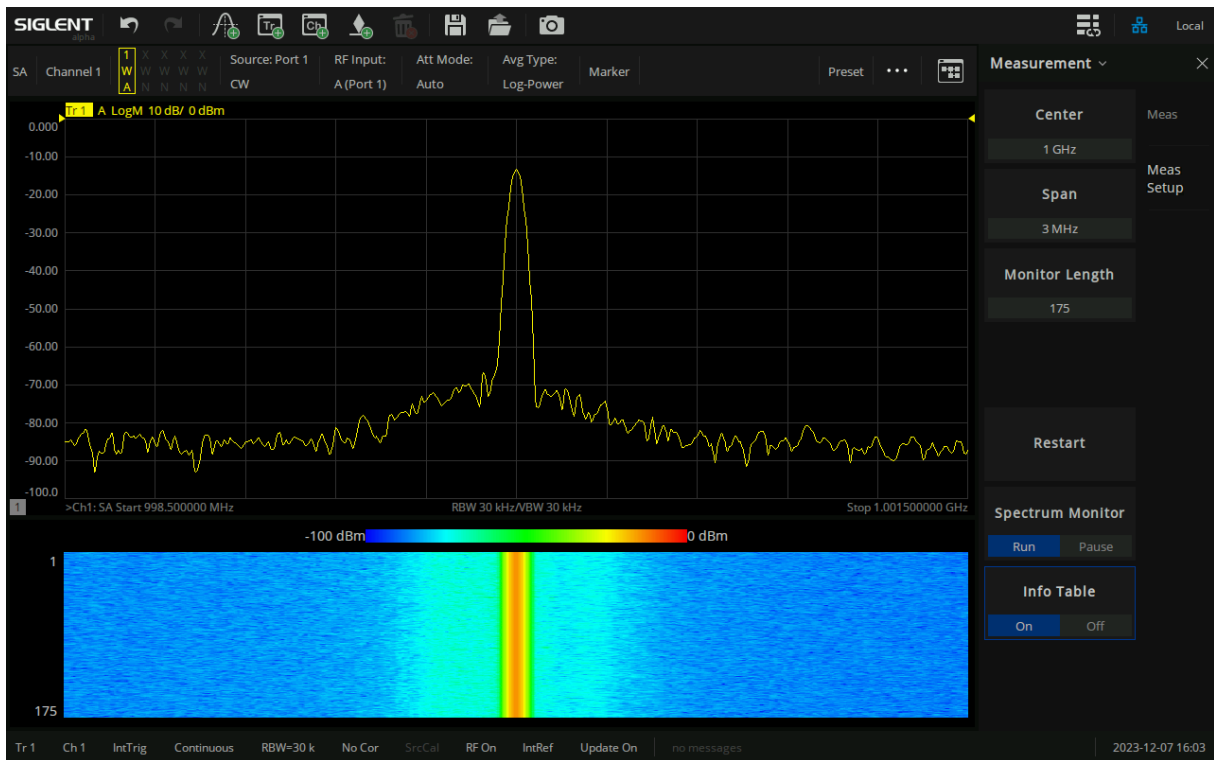

Figure 11-18 Spectrum Monitor

Monitor Length: Set the length of the Monitor. The minimum value is 10 and the maximum value is 800.

Restart: clear the measurement and then restart it.

Spectrum Monitor Run/Pause: User can choose whether to run/pause the spectrum monitoring. If the current state is running, click the "Spectrum monitoring" menu to pause the monitoring, and the spectrum monitoring chart will not be refreshed. If the current state is pause, click the "Spectrum monitoring" button to start the monitoring, and the spectrum monitoring chart will continue to refresh after the previous suspended state.

11.5.7.2 Spectrum Monitor Info Table

When the information table is "On", click other menu options, the result information table will not close, Otherwise close the result information table.

- The horizontal is the frequency axis, the vertical is the time axis, and the color represents the energy magnitude of the spectrum.
- It is used to monitor the frequency spectrum of discontinuity. Through the frequency spectrum monitoring, the change of the signal in a period of time can be observed.
- The spectrum monitoring chart is refreshed from the bottom up, and the number marked on the left indicates the maximum number of monitoring frames that can be displayed in the current spectrum display window. Note that the frame number may be less than the monitoring length set by the user, and the monitoring length does not conflict with the maximum number of monitoring frames that can be displayed. If the length of the spectrum monitoring chart is less than 40, and the left side will not display the numbers.
- The maximum and minimum values of the measurement level in the current trace window are displayed at the left and right ends of the reference color bar, and the reference color bar is aligned with the spectrum monitoring chart in the center. When the spectrum display window is less than a certain value, the measurement level value is not displayed, and only the color bar is displayed.
- The spectrum monitoring chart is aligned with the frequency of the trace window to indicate the one-to-one correspondence between the spectrum monitoring chart and the frequency.

12 The Frequency Offset Mode

12.1 Overview

Generally with network analyzers, the frequency must be the same both at the signal source and at the receiver, so frequency-translating devices such as mixers or converters cannot be measured. To enable the analyzer to measure frequency conversion devices, the receiver frequency must be synchronized with a frequency consisting of the input frequency and a certain added offset, which is called frequency-offset sweep. The frequency offset sweep function of SNA6000A can be used for mixers related measurement.

The SNA6000A provides not only this frequency-offset sweep but state-of-the-art mixer calibration features: scalar-mixer calibration. Scalar-Mixer Calibration performs high-accuracy measurement for the magnitude and reflection parameter of mixer conversion loss.

Moreover, the SNA6000A supports an absolute measurement function. The network analyzers normally measure the ratio of the test signal's magnitude and phase to the reference signal. In contrast, the absolute measurement function performs a measurement of the absolute value of the test signal's magnitude. In combination with the frequency-offset function, the absolute measurement function provides measurements that include measurement of harmonic distortion. It also provides high-accuracy measurement when combined with Power Calibration and Receiver Calibration.

12.2 Frequency Offset Mode

Frequency Offset Mode (FOM) enables the SNA internal RF signal source and SNA port receiver to operate at different frequencies. To realize the measurement of nonlinear characteristics of the device.

12.2.1 Frequency Offset settings

Press **[Freq] > Freq Offset...** to enter the frequency offset function setting dialog box.

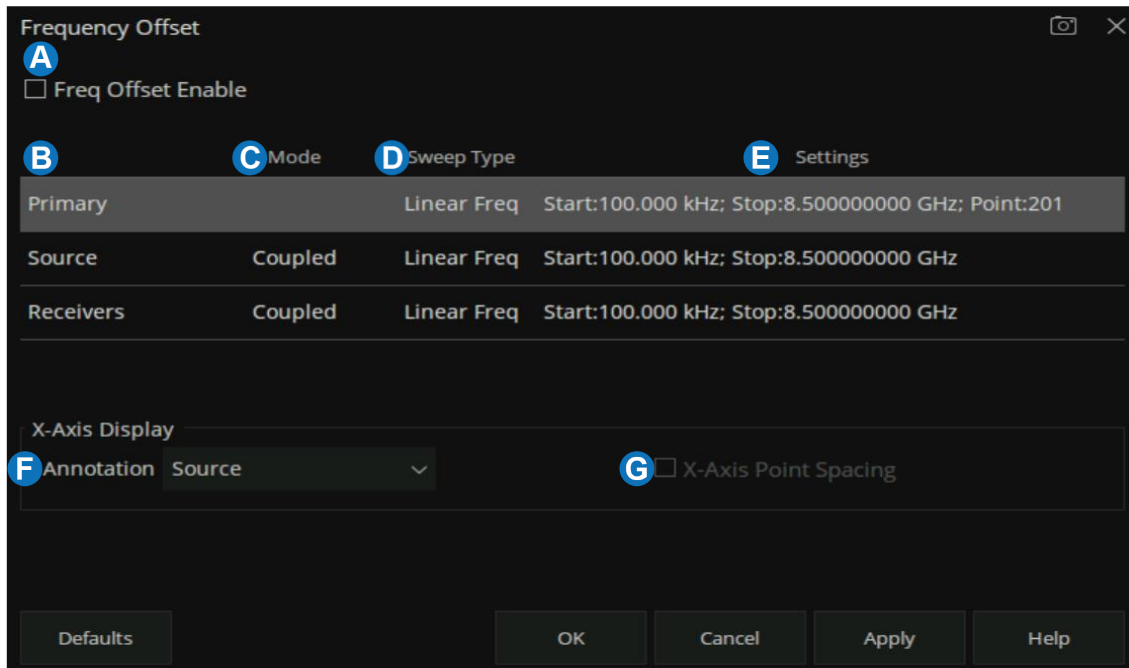

A. Frequency Offset (ON/OFF) Enables Frequency Offset Mode on ALL measurements that are present in the active channel. When frequency offset function is not enabled, all frequencies are the same as the Primary frequency.

B. Sources and Receivers

- Primary the current Active Channel settings. When a Source or Receiver is coupled to the Primary settings, its Sweep Type is the same as that of the Primary. The frequency settings of the coupled range are mathematically derived from the Primary settings using the Multiplier, Divisor and offset values. With this approach, only the Primary settings need to be changed in order to affect change in the coupled Sources and Receivers. Changes to the Primary channel settings occur when Frequency Offset is checked ON.

Primary settings are only used when Sources and Receivers are Coupled. It is often easier to Uncouple, then set Sources and Receivers independently.

- Source the internal source signal of the VNA.
- Receivers All receivers that are used in the channel, including Reference receivers, are tuned to the specified frequency settings.

C. Mode

- Coupled Source and Receiver settings are mathematically derived from the Primary settings using Multiplier, Divisor, and Offset values.
 - Uncoupled Source and Receiver settings are entered independently, without reference to Primary settings. When Uncoupled, Source and Receiver Ranges can use separate sweep types.
- D. Sweep Type** Click to change the type of sweep for each range. Only available for Primary and Uncoupled Sources and Receivers.
- E. Settings** To change settings click IN the appropriate Settings cell, then will pop up the corresponding settings dialog box that can be edited. If coupled, invokes the Coupled dialog. If uncoupled or Primary invokes the Uncoupled settings dialog.
- F. X-Axis Annotation** Select the settings to be displayed on the X-Axis.
- G. X-Axis Point Spacing** Only available when a Segment Sweep Type is selected as the X-Axis display.

Coupled settings dialog box

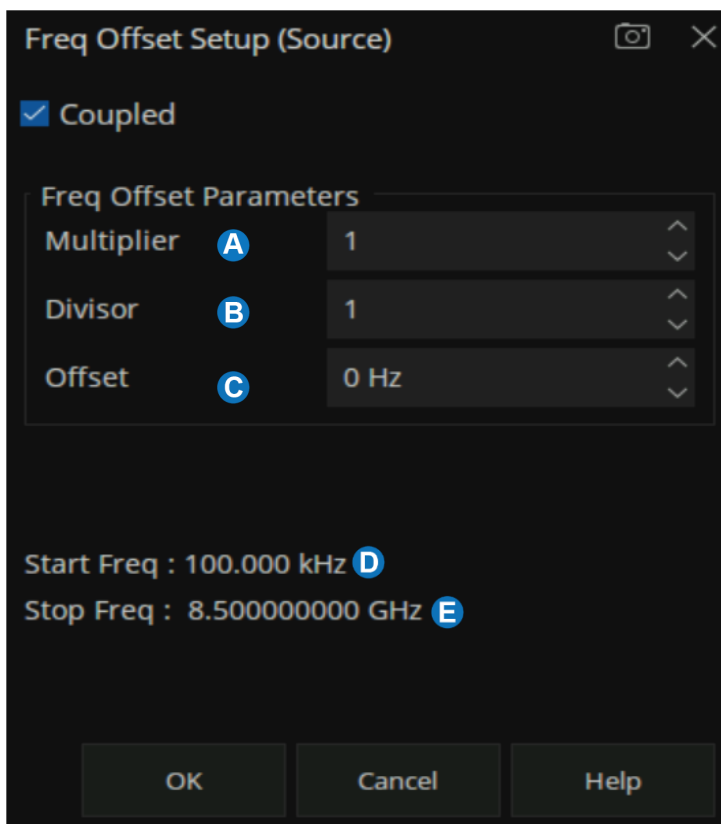

A. **Multiplier** Specifies (along with the divisor) the value to multiply by the stimulus. The value is

an integer from -100 to 100.

- B. **Divisor** Specifies (along with the multiplier) the value to multiply the stimulus. The value is an integer from -100 to 100.
- C. **Offset** Specify the absolute offset frequency (Hz). For the mixer, this will be the LO frequency. The range is [-5000GHz, 5000GHz].
- D. **Start Freq** = [Primary Start x (Multiplier / Divisor)] + Offset
- E. **Stop Freq** = [Primary Stop x (Multiplier / Divisor)] + Offset

Primary and Uncoupled settings dialog box

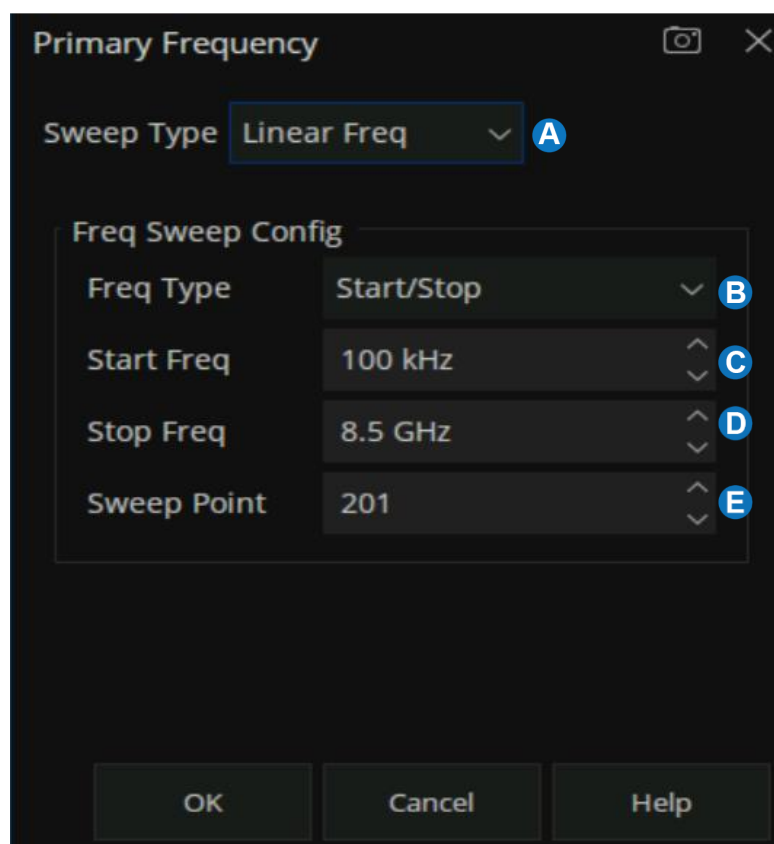

- A. **Sweep Type** The settings dialog box is vary depending on the sweep type.
- B. **Frequency Type** Select Start / Stop or Center / span.
- C. **Start Freq** Enter values.
- D. **Stop Freq** Enter values.
- E. **Sweep Point** (Primary only) Enter number of data points for the sweep.

Tip:

When sweep type is Segment Sweep, the segment table edits are made exactly like the standard segment table. In segment sweep mode:

- The OK button is NOT available until the total number of data points for all segments matches the number of Primary data points.
- Independent IF Bandwidth and Independent Sweep Time are available ONLY on the Primary (channel) and the Uncoupled Receivers - NOT Sources.
- Independent Power is available ONLY on the Primary (channel) and the Uncoupled Sources - NOT Receivers.

13 Scalar Mixer Measurements(SMM Option)

To get more accurate measurement results, connect the DUT to the VNA port as the following figure. Before measuring the scalar mixer, the VNA should be fully preheated and then do the following steps:

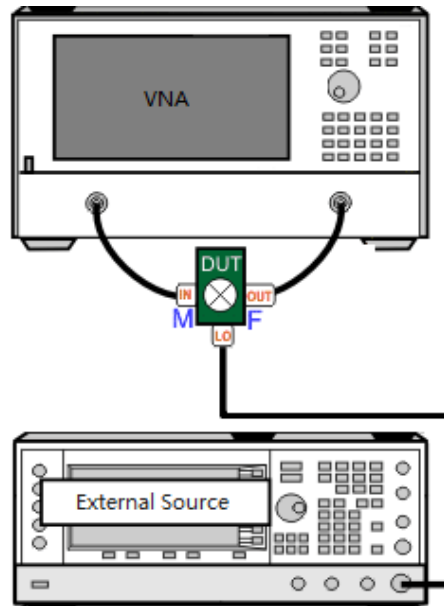

1. Create an SMM measurement
2. Configure the Scalar mixer setup
3. Do the Source Power Calibrate of the SMM mode (optional)
4. Do the Receiver Calibrate of the SMM mode (optional)
5. Do the SMM Calibration
6. Do the scalar mixer measurement

13.1 Create an SMM measurement

Press **[Meas] > S-Params > Mode > SMM**. The SMM channel selection dialog box will displayed after the SMM measurement mode was selected. Select “Active Channel” (delete the existing measurement) or “New Channel” then click OK. A Scalar mixer measurement is displayed on the current channel or on a new channel and New Window.

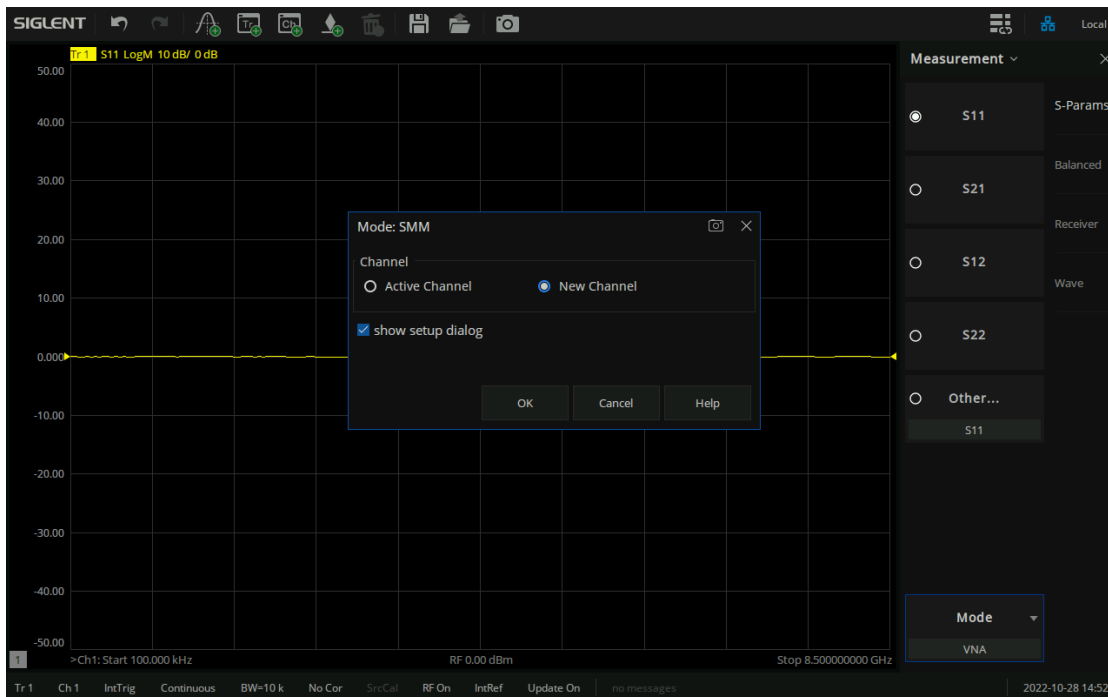

Figure 13-1 SMM mode channel selection dialog box

In the interface of the SMM channel selection dialog box, the “Mixer Measure dialog” check box is selected by default. when user clicks “OK”, a SA Setup dialog box will be displayed that can set related parameters. As figure shown below:

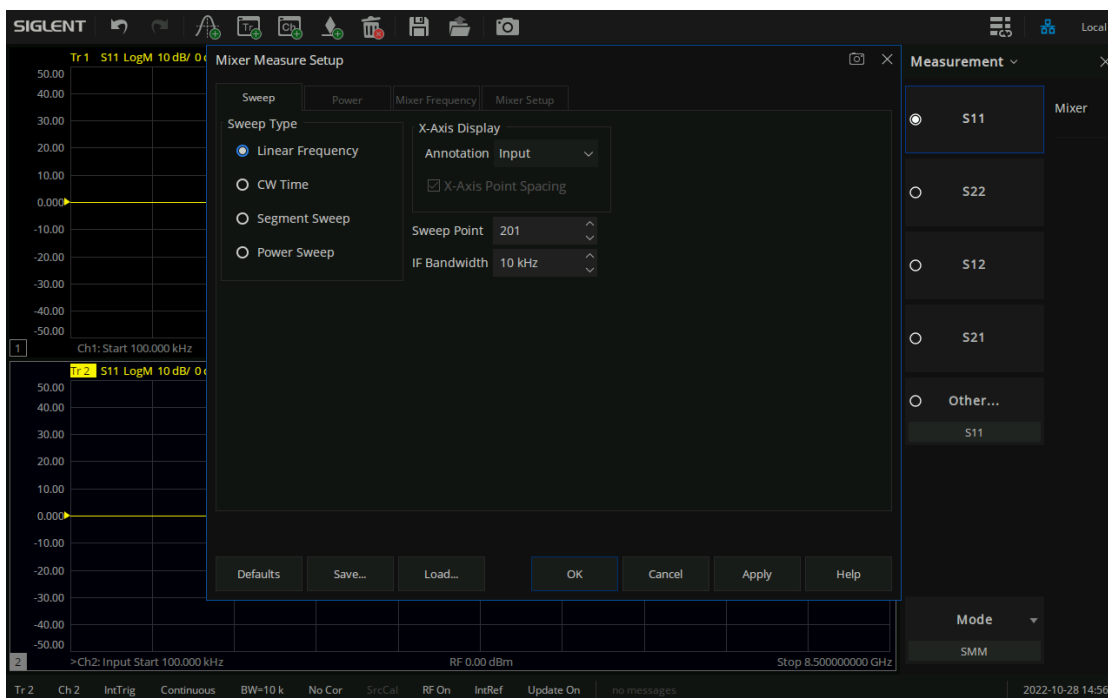
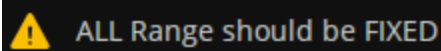

Figure 13-2 Mixer Measure Setup dialog

If the show Setup Dialog check box is deselected, the Mixer Measure Setup dialog box will not be displayed when the SMM function is enabled. If the user needs to modify the SMM parameter settings again, the Mixer Measure Setup dialog box can be called up by pressing the front panel Stimulus key [Start] / [Stop] / [Freq] / [Power] / [Sweep] > Mixer Measure....

13.2 Configure the Scalar mixer setup

Configuring the SMC Setup dialog can be challenging at first. Warning messages like this one appear at the bottom of the Setup dialog to notify you of an invalid setup.



At least one range (Input, LO, or Output) MUST be Fixed. The following are the Valid Mixer Configurations:

Sweep Type	input	Local	Output
Linear Frequency	Sweep	Sweep	Fixed
	Sweep	Fixed	Sweep
	Fixed	Sweep	Sweep
CW Time Power	Fixed	Fixed	Fixed

Although you will soon become comfortable navigating these tabs, at first it may be best to complete the dialog in the following order:

1. Enter the Mixer Measure Setup dialog box
2. Select Sweep tab settings.
3. Select Power tab settings.
4. Select Mixer Frequency tab settings.
5. Select Mixer Setup tab settings.

13.2.1 Sweep Tab-Mixer Measure Setup box

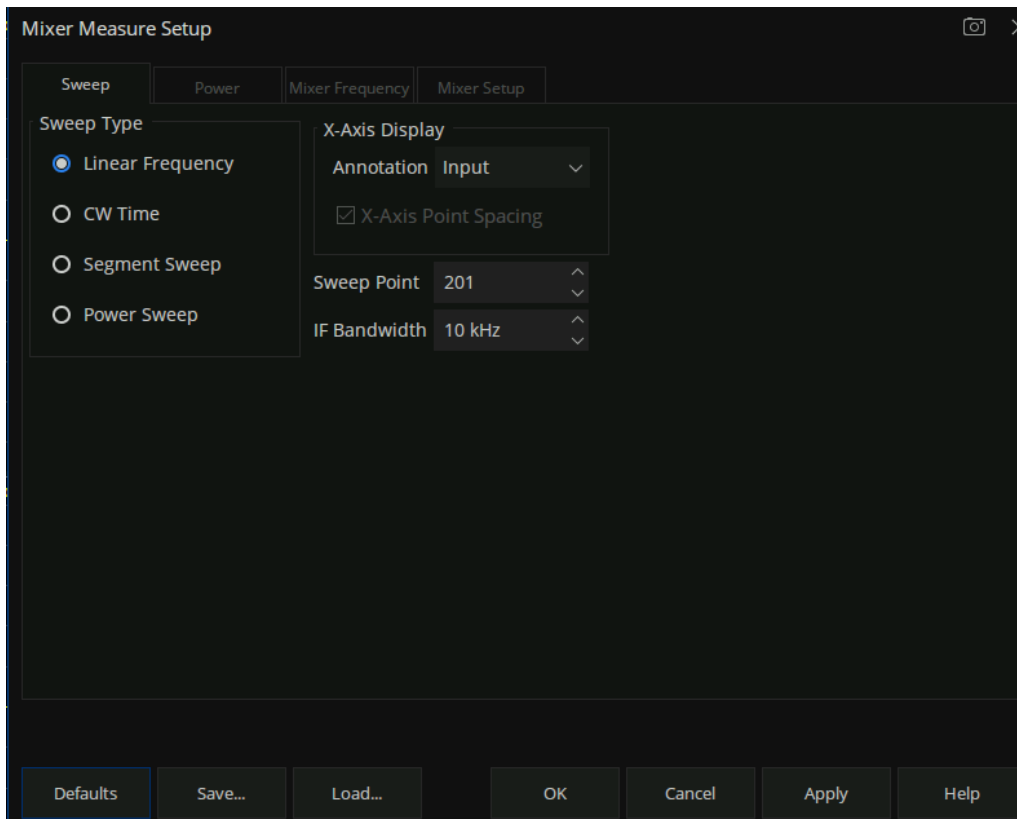

Figure 13-3 Sweep Type Tab

Sweep Type:

- Linear frequency: Measurements are displayed on a standard grid with ten equal horizontal divisions.
- CW Time: All ranges are set to a Fixed (CW) frequency, and the data is displayed versus time.
- Segment Sweep: Sweep user-defined segments.
- Power Sweep: Input or LO power.

X-Axis Display:

Select the frequency range for displaying the sweep parameters (input, output, LO) on the X-axis.

X-Axis Point Spacing Available only with Segment Sweep.

Sweep Point: The number of data points that the analyzer measures across a sweep.

IF Bandwidth: The received signal is converted from its source frequency to a lower intermediate

frequency (IF).

13.2.2 Power Tab-Mixer Measure Setup box

Configures Input and Output power settings for an SMM measurement.

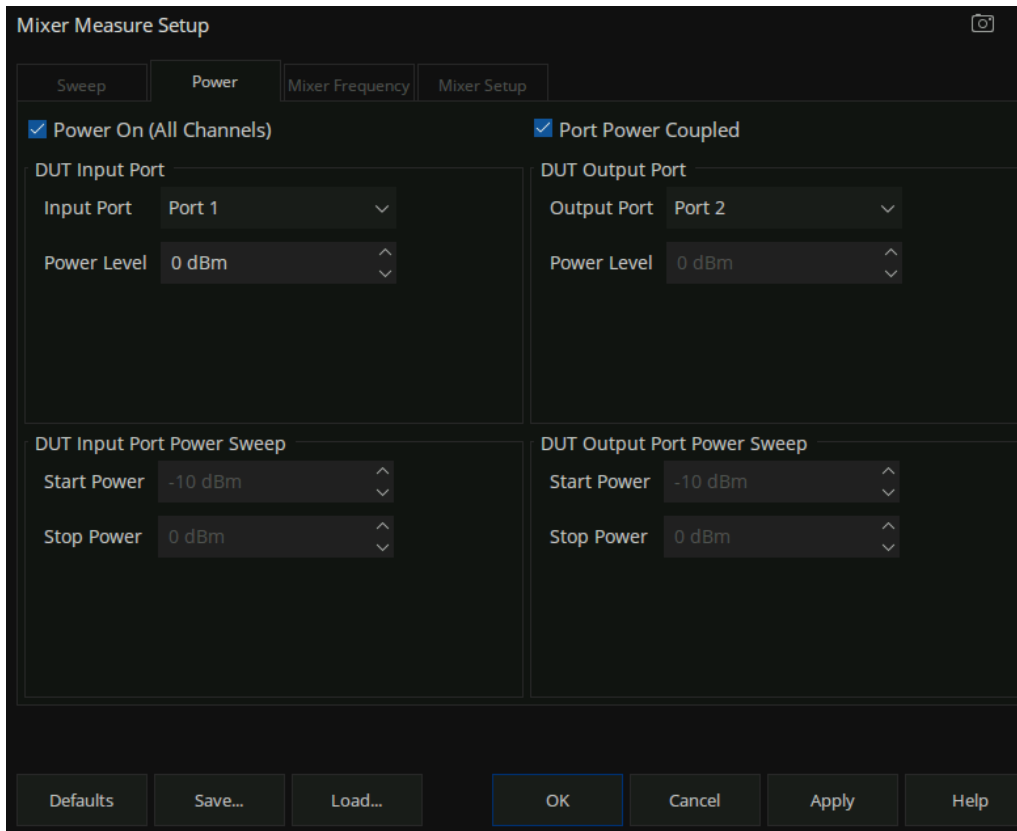

Figure 13-4 Power Tab

Power On (All Channels): To turn the internal RF Power ON or turn power OFF for all channels.

Port Power Coupled: To set the same power level at the DUT Input and Output ports.

DUT Input Port: Select the VNA port that is connected to the DUT Input then Set the power level to the DUT Input port.

DUT Output Port: Select the VNA port that is connected to the DUT Output then Set the power level to the DUT Output port.

DUT Input and Output Port Power Sweep: Available when Power (sweep) is selected on the Sweep tab. And the Start and Stop Power editing boxes can be edit.

13.2.3 Mixer Frequency Tab-Mixer Measure Setup box

13.2.3.1 Mixer Frequency setting

Input: The stimulus frequencies of the DUT.

Output: the response frequencies of the DUT after conversion (either UP or DOWN).

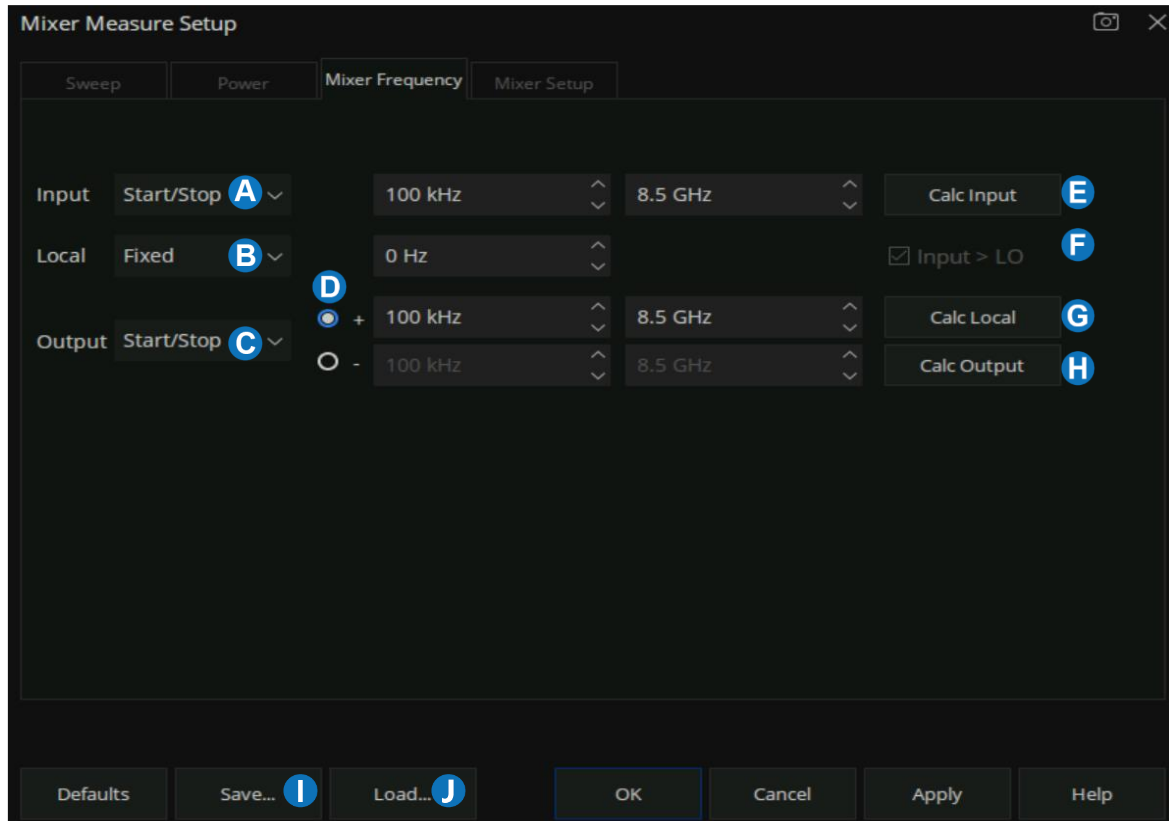

Figure 13-5 Mixer Frequency Tab

Frequency Format can select Start / Stop (Swept) or Fixed. For Linear sweep type, at least one of these must be fixed. For CW or Power, ALL must be Fixed.

- A. Select the DUT Input frequency format.
- B. Select the LO frequency format.
- C. Select the DUT Output frequency format.
- D. Mixer-Product Selector. Determines whether the receivers will tune to the Sum (+) or the Difference (-) of the Input and LO frequency.
- E. Calculates Input frequency settings based on your other mixer settings. For example, enter the Output frequency range and LO frequency range, then press “**Calc Input**”. The VNA will calculate and display the Input frequency.

- F. Input > LO When DUT selects down-conversion mode and Input signal > local, this box must be selected, and then the output frequency can be calculated by clicking “Calc Output” button.
- G. Calculates LO frequency settings based on your other mixer settings. For example, enter the Input frequency range and Output frequency range, then press “**Calc Local**”. The VNA will calculate and display the LO frequency.
- H. Calculates Output frequency settings based on your other mixer settings. For example, enter the Input frequency range and LO frequency range, then press “**Calc Local**”. The VNA will calculate and display the Output frequency.
- I. Saves some of the mixer settings to a “*.mxr” file. The saved Settings are Sweep Type (when Segment Sweep Type, all segment settings are saved), Frequency and power settings.
- J. Recalls a previously-configured mixer “*.mxr” file.

13.2.3.2 Segment Sweep Mixer Frequency setting

The following settings appear on the Mixer Frequency tab when Segment Sweep is selected on the Sweep tab.

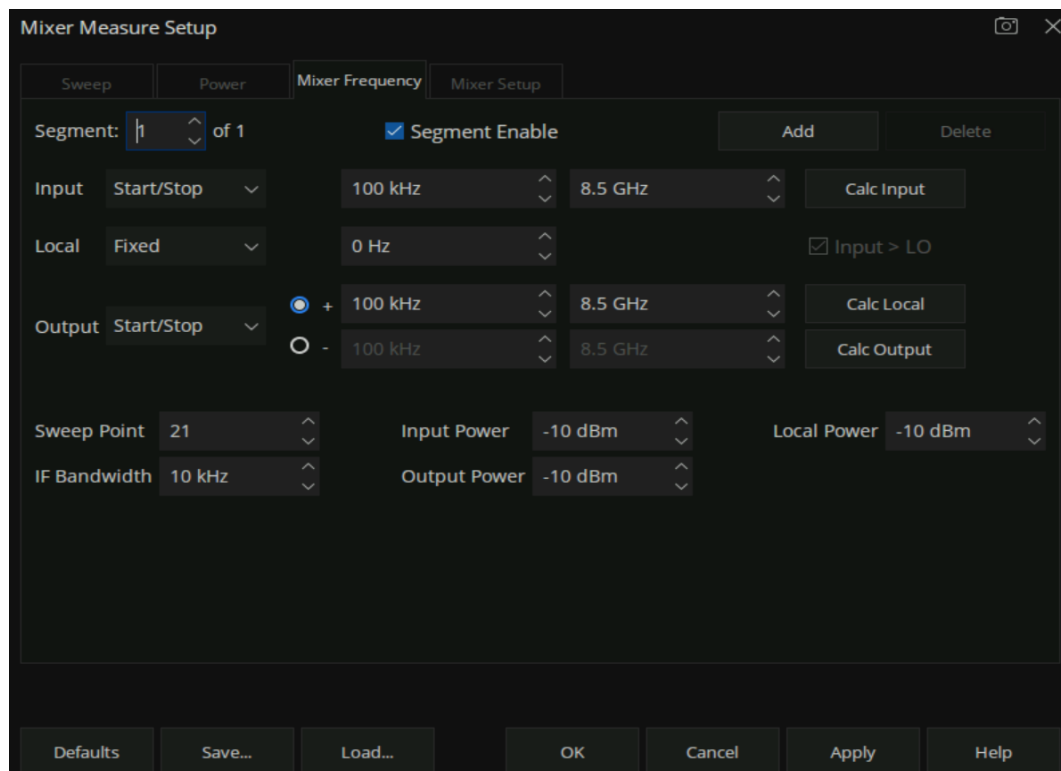

Figure 13-6 Segment Sweep Mixer Frequency Tab

How to configure a segment using the GUI:

1. Click “Add”. To add a segment.
2. Click “Delete” to remove a segment and renumber all subsequent segments.
3. State is ON by default. Click OFF and that segment will not be included in the sweep.
4. Configure Frequency settings for Input, LO, and Output ranges.
 - For each segment, the same sweep requirements apply as a standard (non-segment) sweep. For example, at least one range MUST be Fixed (Start = Stop frequencies).
 - The Input, Output, and LO frequencies of segments are allowed to overlap other segments.
 - All segments must sweep in either the forward (Start<Stop) or reverse (Start>Stop) directions. Mixed sweep directions are NOT allowed.
 - The following settings can be set independently for each segment:
 - a) Number of Points - Total number of points for all segments is limited to the Max allowed by the VNA.
 - b) IF Bandwidth
 - c) Port Powers: Input, Output, LO. These settings override the settings on the Power tab
 - The following settings apply to ALL segments:
 - a) LO Source Selections
 - b) All Input and LO Multipliers and Dividers
 - c) Source Leveling
 - d) X-Axis Display
 - e) X-Axis Point Spacing
 - Mixer Segment setup information is saved to a “*.mxr” file.

13.2.3.3 Mixer frequency configuration rules

The warning message at the bottom of the dialog box indicates that one or more of the following settings are invalid:

- One of the input frequency, LO frequency, and output frequency of DUT must be a fixed frequency range, or all three of them must be a fixed frequency range
- The input or output frequency cannot exceed the VNA frequency range

13.2.4 Mixer Setup Tab-Mixer Measure Setup box

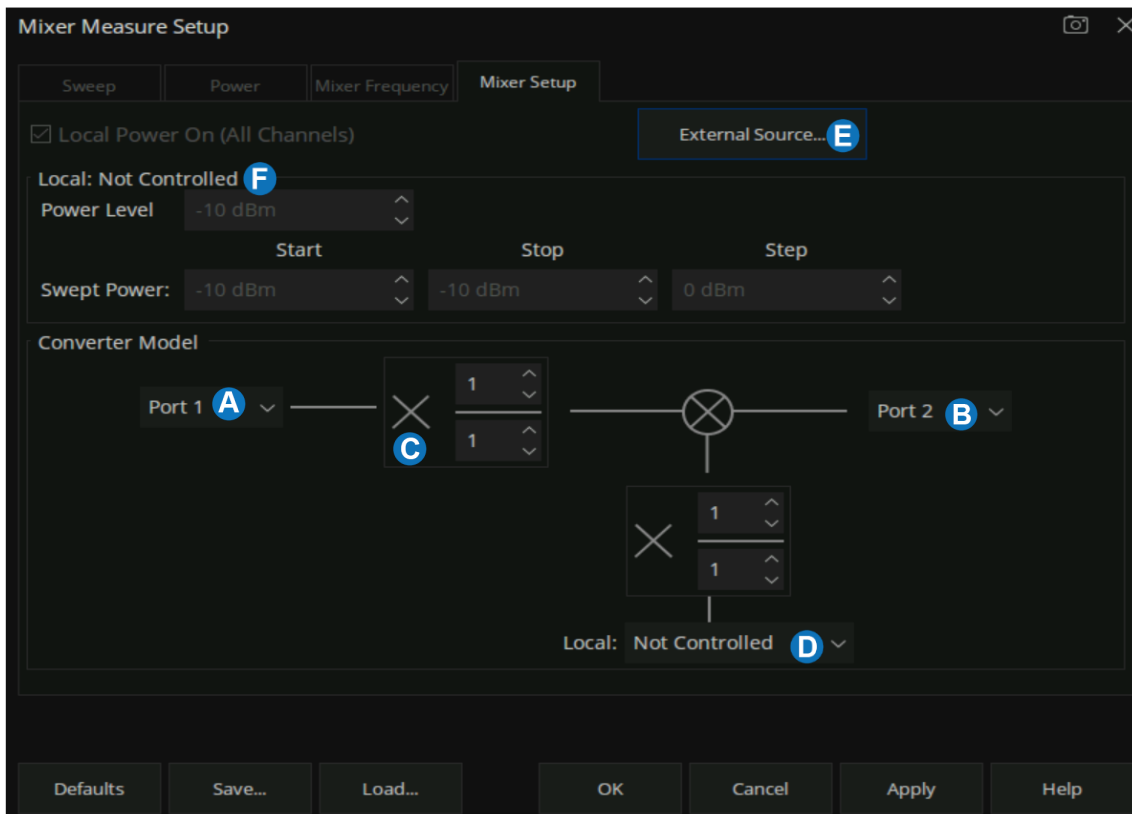

Figure 13-7 Mixer Setup Tab

- A. Select the VNA port to connect to the DUT input.
- B. Select the VNA port to connect to the DUT input.
- C. Fractional Multipliers $\times \frac{1}{1}$, The combination of (numerator / denominator) forms a fractional value that is multiplied by the input and LO frequency ranges. These values are used to calculate the response frequency of the VNA receiver for the converter output. The range for the numerator and denominator of a fractional multiplier is from -100 to +100. The denominator cannot be set to 0.
- D. Select "Not controlled" to allow an external source to provide a Fixed LO Frequency at all times. Select "Port 3" or "Port 4" to allow an internal source provides variable frequency used as the LO. Otherwise, select an External source to be controlled by VNA and provides variable frequency used as the LO.
- E. Add External Source. Connect the External Source device to any USB port of the VNA by the USB cable, then click "External Source", after the VNA identifies the External Source, the external source information will displayed in the External Source dialog box. When LO selects a

external source, the VNA controls the external source to provide the specified frequency output based on the local frequency and power configuration.

F. Available when select a external source to provide the LO frequency.

Fractional Multiplier Examples

Example 1: Use the LO fractional multiplier to replicate the action of the third-harmonic mixer so the VNA can accurately calculate the receiver frequency. The input and LO frequencies are known.

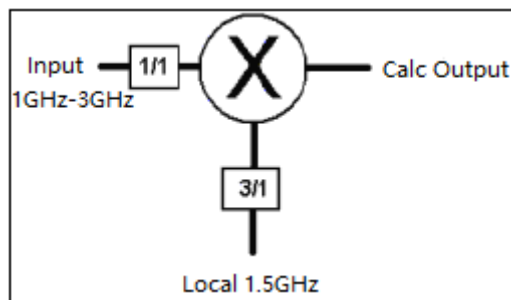

Enter these settings in the **Mixer Setup** dialog box:

- Input Start Freq : 1GHz
- Input Stop Freq : 3GHz
- LO Fixed Freq : 1.5GHz
- Mixer-Product Selector: different ("-")
- Input fractional multiplier: 1/1
- LO fractional multiplier: 3/1
- Click "Calc Output"
- Result : Output Start Freq: 3.5GHz, Output Stop Freq 1.5GHz.

Example 2: Use the fractional multipliers to tune the VNA receiver frequency to the second harmonic of the mixer's 8 GHz fundamental output. The input, LO, and output frequencies are known.

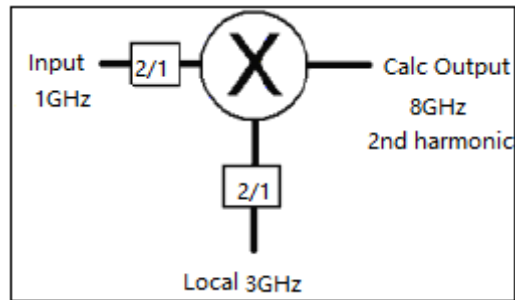

Enter these settings in the **Mixer Setup** dialog box:

- Input Fixed Freq: 1GHz
- LO Fixed Freq: 3GHz
- Mixer-Product Selector: sum (“+”)
- Input fractional multiplier: 2/1
- LO fractional multiplier: 2/1
- Click “Calc Output”
- Result : Output Fixed Freq: 8GHz.

Example 3: Use the LO fractional multiplier to replicate the action of the divide-by-two mechanism inside the mixer package. Having done this, the VNA can accurately calculate the receiver frequency. The input and LO frequencies are known.

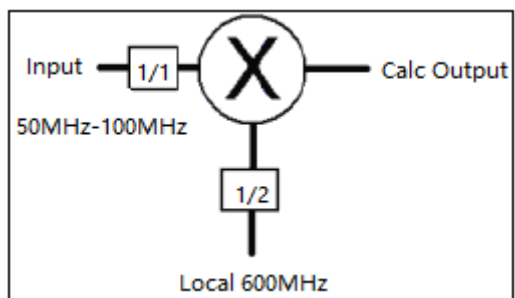

Enter these settings in the **Mixer Setup** dialog box:

- Input Start Freq : 50MHz
- Input Stop Freq : 100MHz
- LO Fixed Freq : 600MHz

- Mixer-Product Selector: sum (“+”)
- Input fractional multiplier: 1/1
- LO fractional multiplier: 2/1
- Click “Calc Output”
- Result : Output Start Freq: 350MHz, Output Stop Freq 400MHz.

13.3 Do the Source Power Cal of the SMM mode (optional)

In the SMM mode, connect the power meter to the VNA port and press the [Cal] key on the front panel > mixer calibration > power calibration > Perform source calibration related configurations > click “Take Cal Sweep” then source power calibration will be performed immediately.

13.4 Do the Receiver Cal of the SMM mode (optional)

In SMM mode, after source power calibration, press the [Cal] key on the front panel > mixer calibration > receiver calibration > receiver calibration related configuration > click “Take Cal Sweep”, then receiver calibration will be performed immediately.

13.5 Do the SMM Calibration

13.5.1 Overview

VNA has a scalar-mixer calibration function for measuring frequency conversion devices.

Scalar-mixer calibration allows you to measure the magnitude value and reflection parameter of the mixer's conversion loss with very high accuracy by performing calibration using calibration standards (OPEN / SHORT / LOAD) in combination as well as a power meter.

For measurement of the conversion loss in a frequency conversion device, normal full 2-port calibration is not available because of the frequency difference between the stimulus port and the response port. Therefore, scalar-mixer calibration allows you to correct the error term that resides in a full 2-port error model by using the error model and an expression based on a new concept.

You can correct the following error elements by using the scalar-mixer calibration.

- The reflection between the output port of the network analyzer and the input port of the measured mixer (vector error correction).
- The reflection between the output port of the measured mixer and the input port of the network analyzer (vector error correction).
- Transmission frequency characteristics at different frequencies (scalar error correction).

Since the transmission tracking (ETF) in the error model used for scalar mixer calibration is a scalar value, the phase part of the compensated transmission measurement result is invalid.

13.5.2 Procedure Using Mechanical Calibration Kit

In scalar mixer measurement mode, only scalar mixer calibration can be used to compensate for S-parameter measurements. In mixer measurement mode, press the “Cal” key on the front panel > Mixer Calibration > Mixer calibration... Enter the mixer calibration wizard interface, default Port1 and Port2 calibration, connect the calibration kit according to the wizard instructions, click the corresponding kit name on the UI to calibrate the scalar mixer.

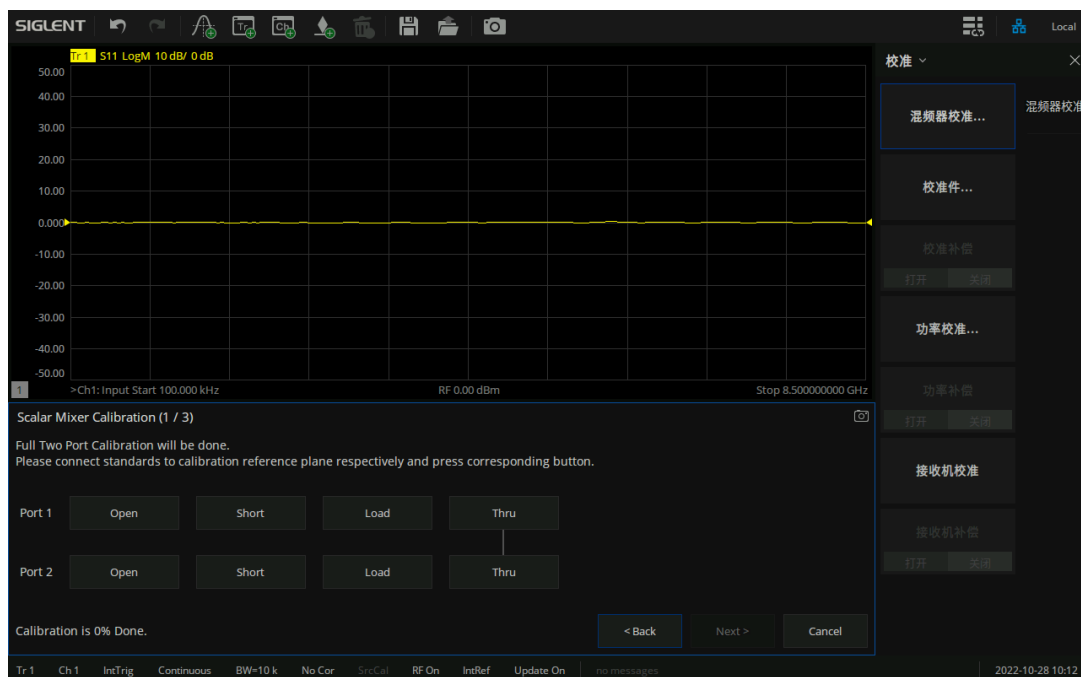

Figure 13-8 The interface of Scalar Mixer Calibration

13.5.3 Checking Calibration Status

After the mixer calibration is complete, the trace status area of the UI displays the type of error calibration that has been performed. For example, the mixer has performed full two-port calibration and the trace calibration status identifier displays “[F2]”.

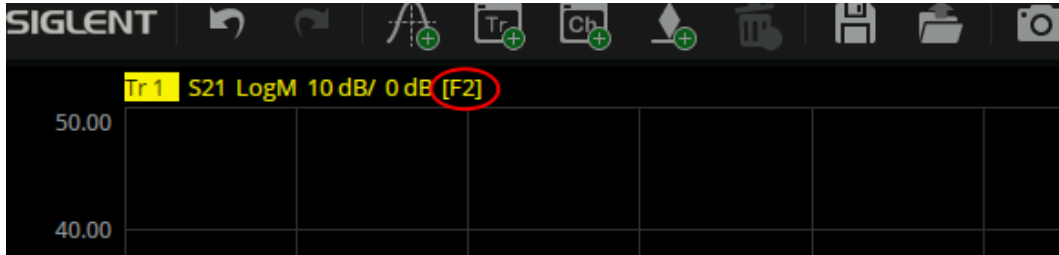

Figure 13-9 Calibration Status

14 Pulse Measurement (PM Option)

14.1 Overview

Pulse measurements are used to test devices that cannot be tested using continuous signals, such as GSM power amplifiers.

To switch on/off the PM option, use the order **Sweep->Pulse Setup**. If you have the trial license for the PM option, an information dialog will appear to notify you that the trial times will decrease. If the trial times expire, a permanent license is needed to switch on the PM option.

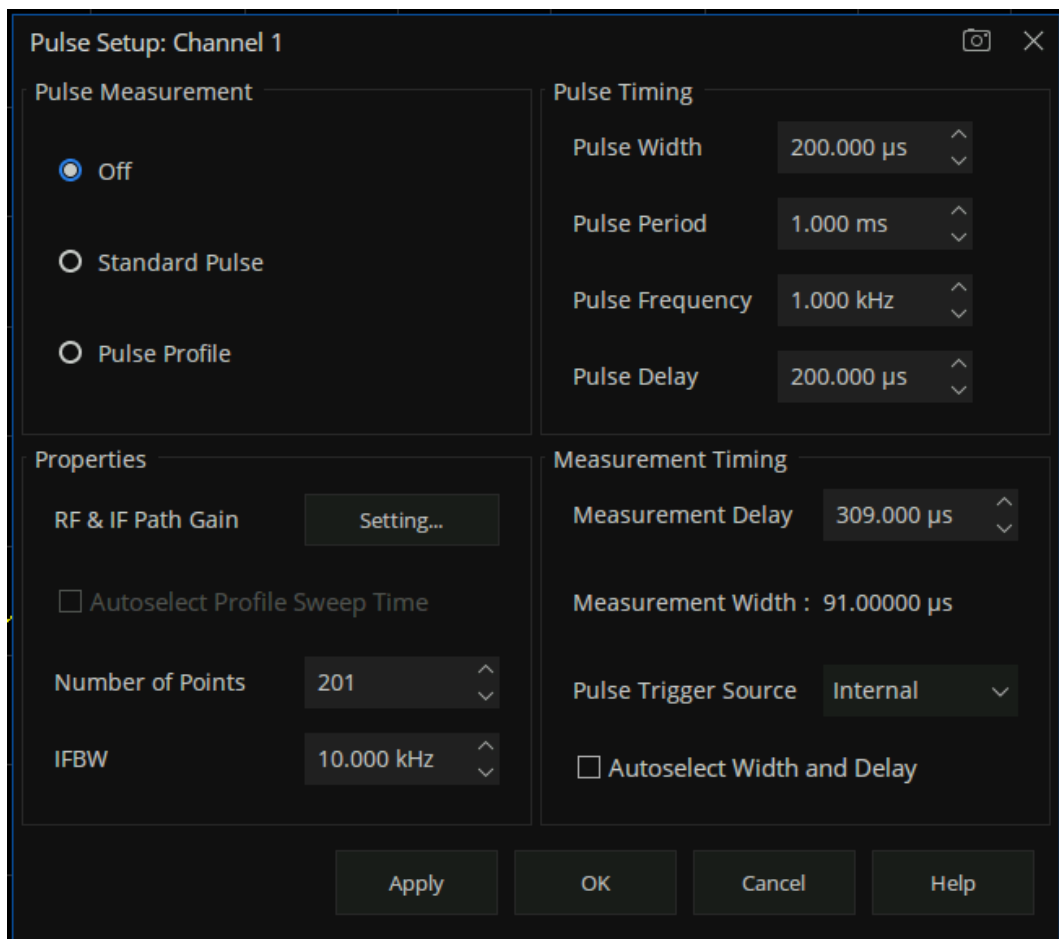

Figure 14-1 The Pulse Measurement setting interface

14.2 Pulse Measurement Settings

14.2.1 Pulse Measurement

Off: Source and Receivers are NOT pulsed

Standard Pulse: With pulsed RF, the SNA can be configured to sweep in frequency, power sweep, and CW time.

Pulse Profile: Pulse profile measurements provides a time domain (CW frequency) view of the pulse envelope.

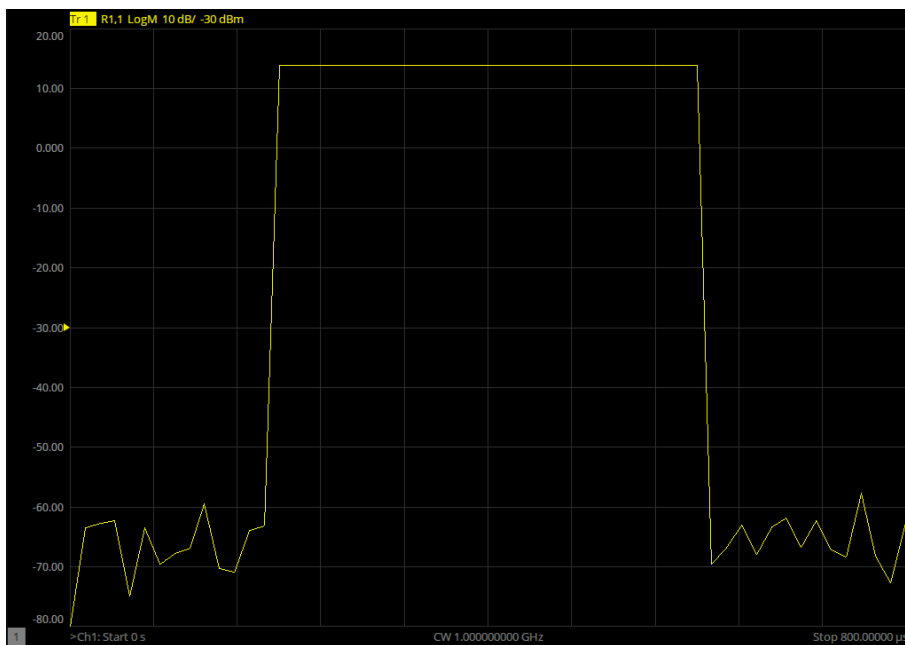
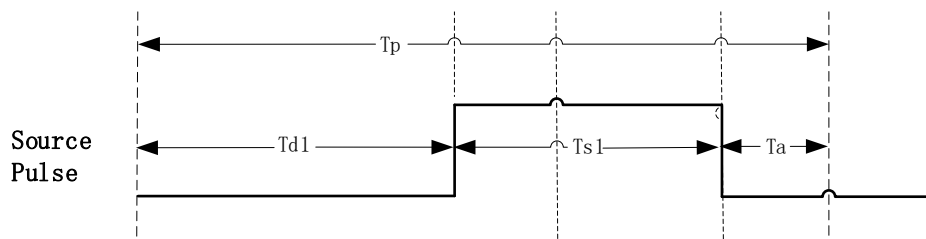

Figure 14-2 Profile Pulse

14.2.2 Pulse Timing



Pulse Width: Sets the width of the source pulse (T_{s1}).

Pulse Period: The time to make one complete pulse (T_p).

Pulse Frequency: The reciprocal of Period ($1/\text{Period}$).

Pulse Delay: The delay between the start of the pulse and the generation of the pulse (T_{d1}).

14.2.3 Properties

RF&IF Path Gain: Click to launch the [RF&IF Path Gain dialog](#).

Autoselect Profile Sweep Time: This function is enabled only in pulse profile mode. When checked, only the source pulse width can be set. The pulse period is automatically set to 2 times the pulse width, and the pulse signal is placed in the middle of the whole signal. This allows you to see a complete pulse in the center of the screen.

Number of Points:

- Standard Pulse: Sets the number of data points for the measurement.
- Pulse Profile: Disable the number setting function, only for display.

IFBW: Select the IFBW for the measurement. The value of IFBW in Profile mode is affected by pulse width and pulse period.

14.2.4 Measurement Timing

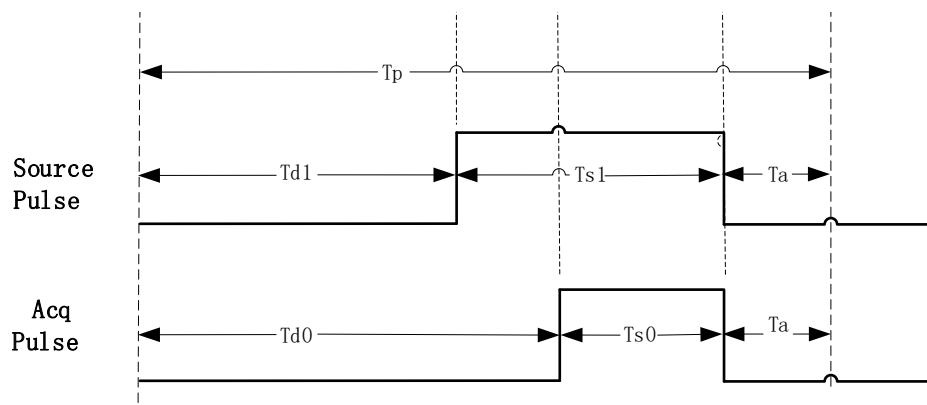

Measurement Delay:

- Standard Pulse: Receiver delay (T_{d0}).
- Pulse Profile: Disabled and has no practical significance.

Measurement Width: Receiver pulse width (T_{s0}), whose value depends on the selected IFBW

value.

Pulse Trigger Source: Set the pulse trigger source.

Autoselect Width and Delay: This function is enabled only in Standard mode. When checked, only pulse period and pulse frequency can be set, and the source pulse width can be adjusted to approximately 75% of the pulse period, with 20% delay. This leaves approximately 5% of the source pulse ON after the acquisition is completed.

14.3 RF&IF Path Gain dialog

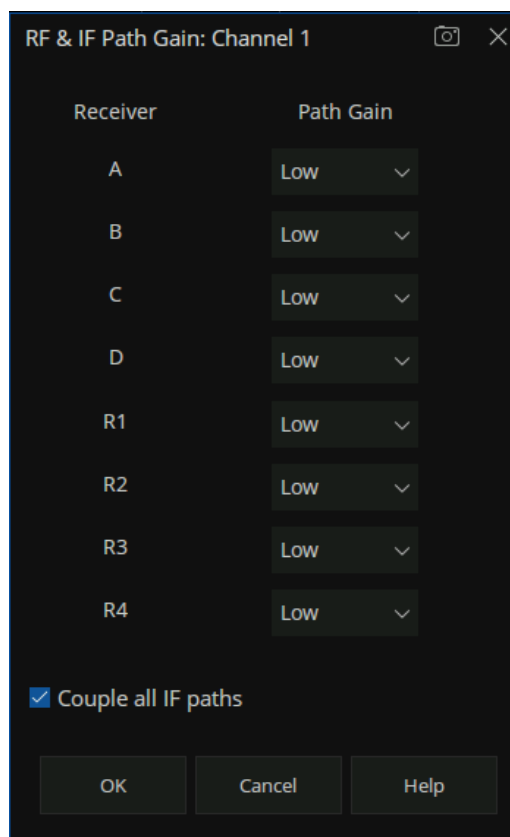

Figure 14-3 RF&IF Path Gain dialog

Receiver: Choose the receiver to be set.

Path Gain:

- Low: The minimum attenuation mode, the average noise level is lower.
- Medium: The medium attenuation mode, the average noise level is normal.
- High: The maximum attenuation mode, the average noise level is higher.

Couple all paths: Check to make the same setting for all receivers.

15 Material Measurement (MT Option)

15.1 Overview

Material measurement can provide key parameter information for many electronic applications, mainly involving the measurement of permittivity and permeability. A sample to be measured is placed in a waveguide measuring device, and both ports of the waveguide device are connected to a calibrated network analyzer through waveguide coaxial converters, as shown in the following figure. Measure parameters S_{11} , S_{22} , S_{21} and S_{12} respectively. By selecting an appropriate data processing method and substituting the S parameter value to calculate the complex relative permittivity and complex relative permeability, the material measurement can be completed.

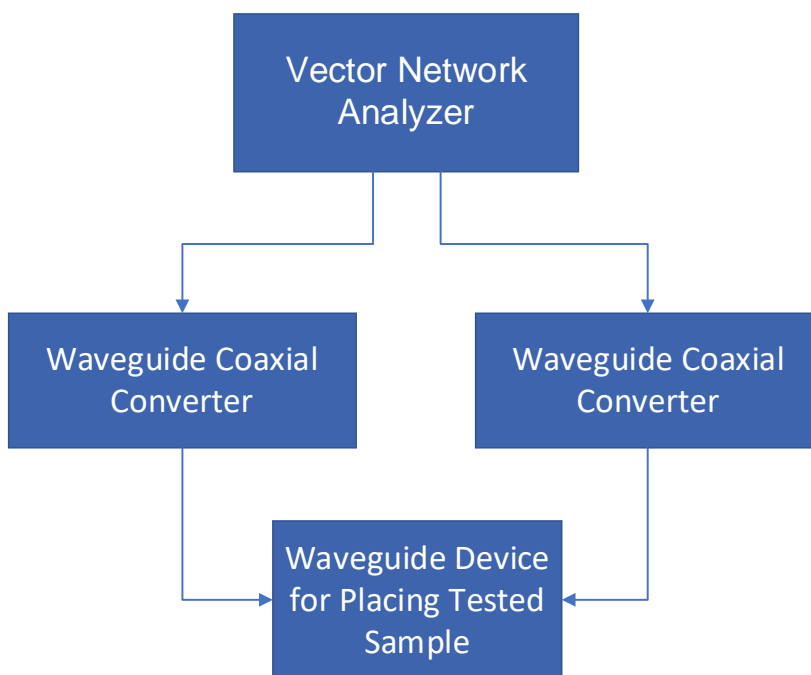

Figure 15-1 Test Schematic Diagram

In order to obtain accurate measurement results, after the waveguide coaxial converter is connected to the VNA port, the VNA should be fully preheated before the material is measured, and the following steps are carried out to realize the material measurement:

1. Create a MT measurement;
2. Configure the Material Measurement Setup;
3. Do the waveguide TRL calibration in material measurement mode;

4. Connect the waveguide and the waveguide coaxial converter to measure the material.

15.2 Create a MT Measurement

Press **[Meas] > Mode > MATERIAL**. After selecting the MATERIAL measurement mode, the user can choose whether to check "New Channel" or not then click OK. A Material measurement is displayed on the current channel or on a new channel and New Window.

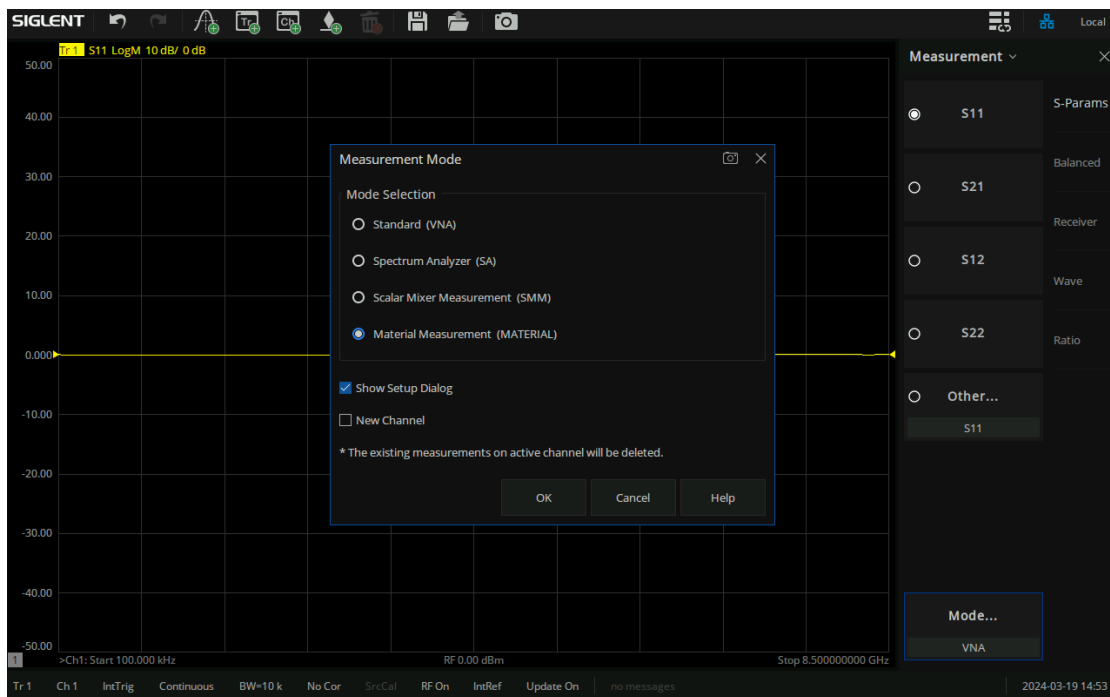

Figure 15-2 MATERIAL mode channel selection dialog box

In the interface of the MATERIAL channel selection dialog box, the “Show Setup Dialog” check box is selected by default. when user clicks “OK”, a Material Measurement Setup dialog box will be displayed that can set related parameters. As figure shown below:

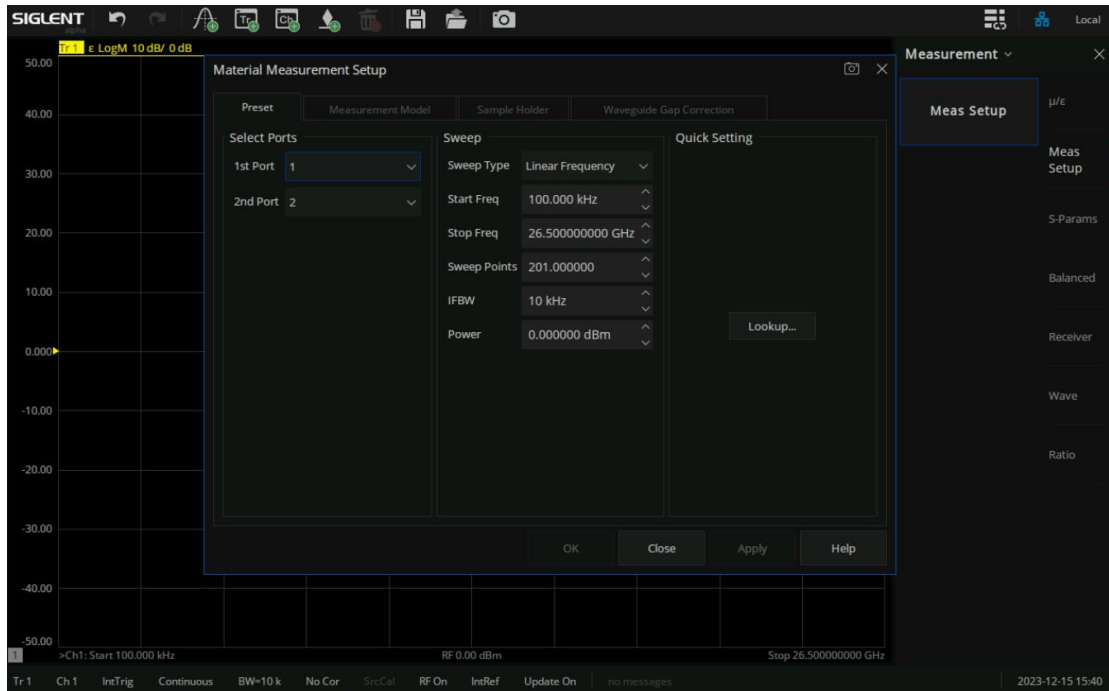

Figure 15-3 Material Measurement Setup dialog box

If the Show Setup Dialog check box is deselected, the Material Measurement Setup dialog box will not be displayed when the MATERIAL function is enabled. If the user wants to modify the MATERIAL parameters, You can call up the Material Measurement Setup dialog box by pressing **【Meas】 > Meas Setup > Meas Setup**.

15.3 Configure the Material Measurement Setup

The Material Measurement Setup dialog box interface has four tabs: Preset tab, Measurement Model tab, Sample Holder tab and Waveguide Gap Correction tab.

15.3.1 Preset Tab

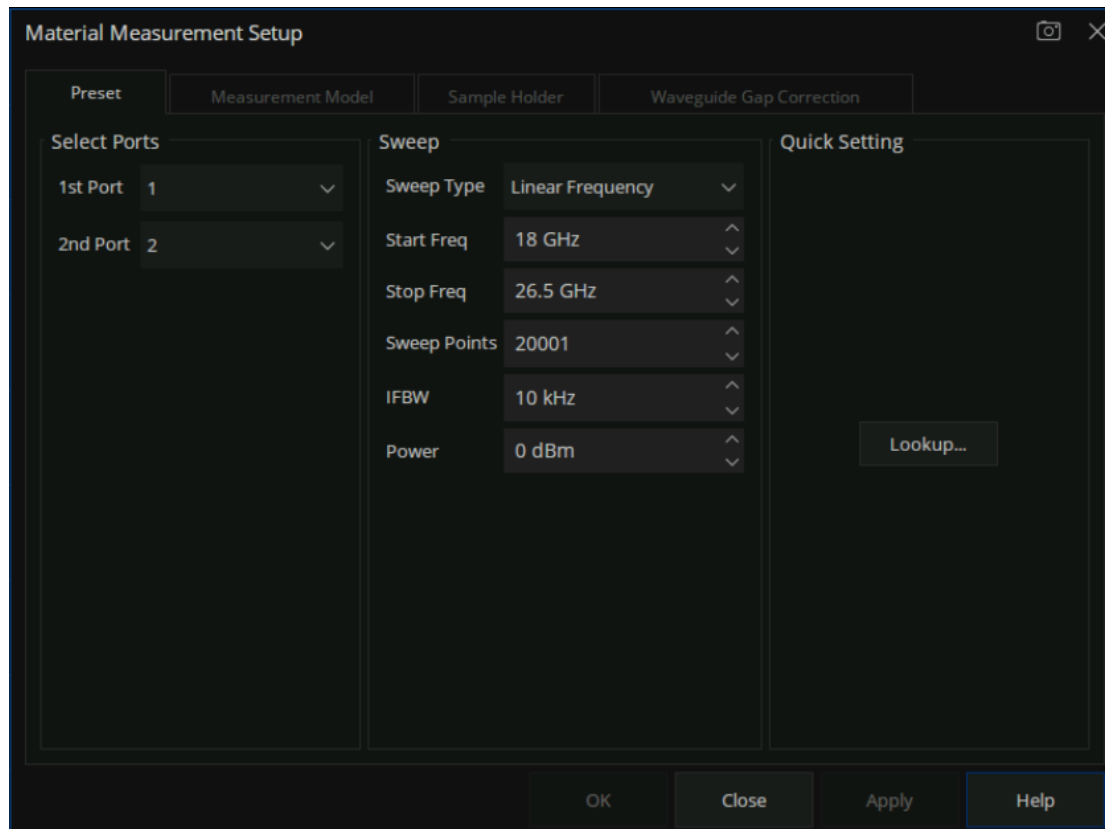

Figure 15-4 Preset Tab

Select Ports:

- 1st Port: Select the port as the forward port for connecting the waveguide holder converter.
- 2nd Port: Select the port as the reverse port for connecting the waveguide holder converter.

Sweep:

- Sweep Type: Set the sweep type, and you can choose Linear Frequency or Log Frequency.
- Start Freq: Set the sweep start frequency.
- Stop Freq: Set the sweep stop frequency.
- Sweep Points: Set the sweep points.
- IFBW: Set the IF bandwidth.
- Power: Set the power level.

Quick Setting: Quickly set relevant parameters according to the information of waveguide holder. Click Lookup... to jump to the Lookup Table tab dialog box, select and set relevant parameters of

waveguide holder, and then click Apply, and the corresponding items will be changed.

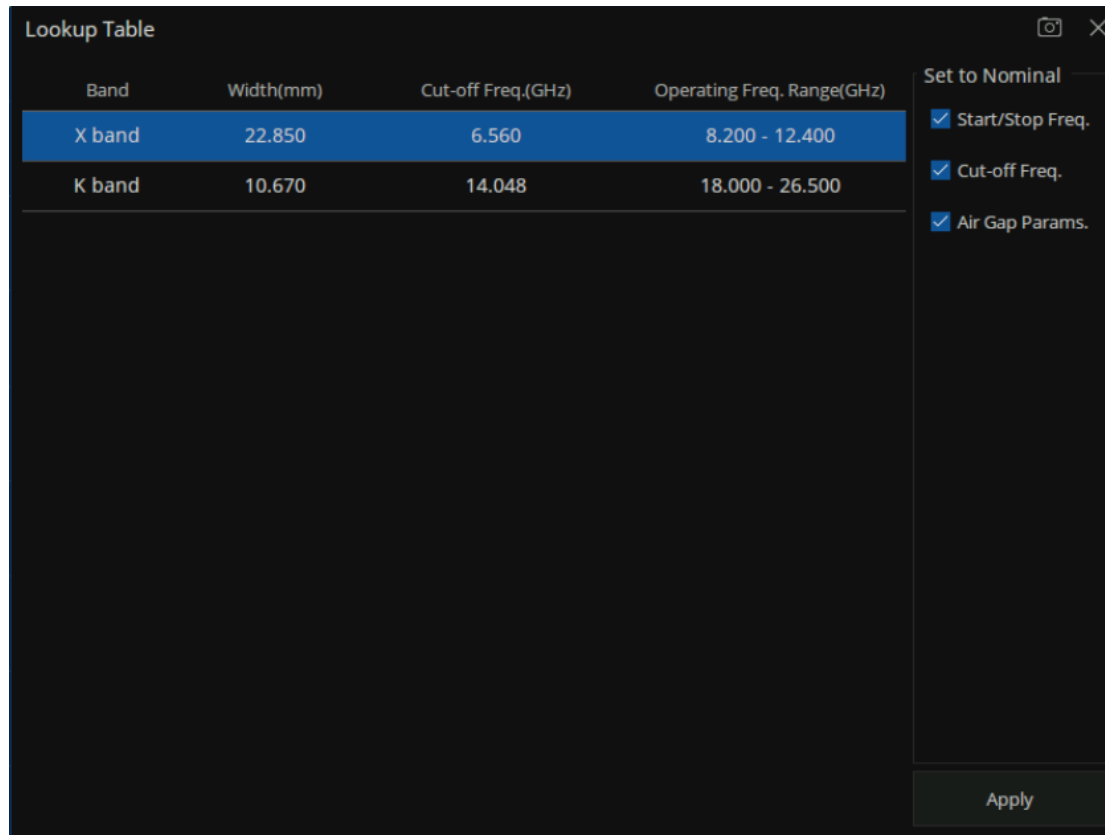

Figure 15-5 Lookup Table Tab

Lookup Table:

- Band: Waveguide bandwidth type.
- Width(mm): The width of the waveguide holder.
- Cut-off Freq(GHz): Cut-off frequency of waveguide holder.
- Operating Freq Range(GHz): Sweep frequency range.
- Set to Nominal: Indicates whether to quickly set relevant parameters according to waveguide information; if it is selected, the parameters of the corresponding item will be set; otherwise, the parameters will not be set.
 - a) Start/Stop Freq.: Start/Stop frequency.
 - b) Cut-off Freq.: Cut-off frequency.
 - c) Air Gap Params.: Air gap parameter. When checked, the width of waveguide holder will be displayed according to the selected waveguide holder.

15.3.2 Measurement Model Tab

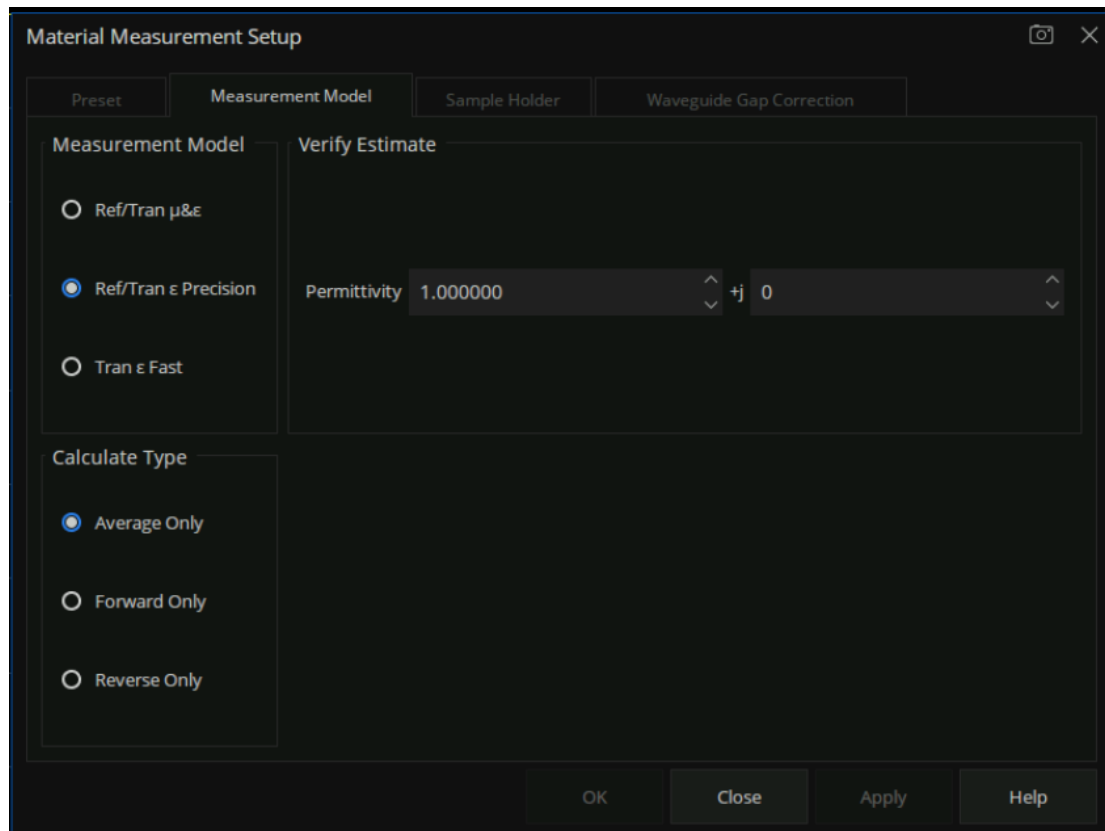

Figure 15-6 Measurement Model Tab

Measurement Model: There are several different measurement models to choose from, and each model has different advantages and limitations.

- Ref/Tran $\mu&\epsilon$: The complex relative permittivity and complex relative permeability of materials are calculated by NRW algorithm, which will be affected by the half-wave syntony of materials, and used to measure the permittivity and permeability of materials.
- Ref/Tran ϵ Precision: The complex relative permittivity of nonmagnetic materials is calculated by NIST algorithm, which is used to measure the permittivity of materials.
- Verify Estimate: Indicates the initial estimated value, which is only displayed under the Ref/Tran ϵ Precision measurement model.
 - Permittivity: Indicates the dielectric constant of the material, and is used to set the initial estimated value of the dielectric constant of the material.

- Tran ϵ Fast: The non-iterative algorithm is used to quickly calculate the complex relative permittivity for non-magnetic materials, which is used to measure the permittivity of materials.

Calculate Type:

- Average Only: After using forward and reverse calculation of material parameters, calculate the average value to obtain the final result.
- Forward Only: Use the transmission coefficient and reflection coefficient of the forward port to calculate material parameters.
- Reverse Only: Use the transmission coefficient and reflection coefficient of the reverse port to calculate material parameters.

15.3.3 Sample Holder Tab

The sample holder tab interface allows you to define sample holder and sample.

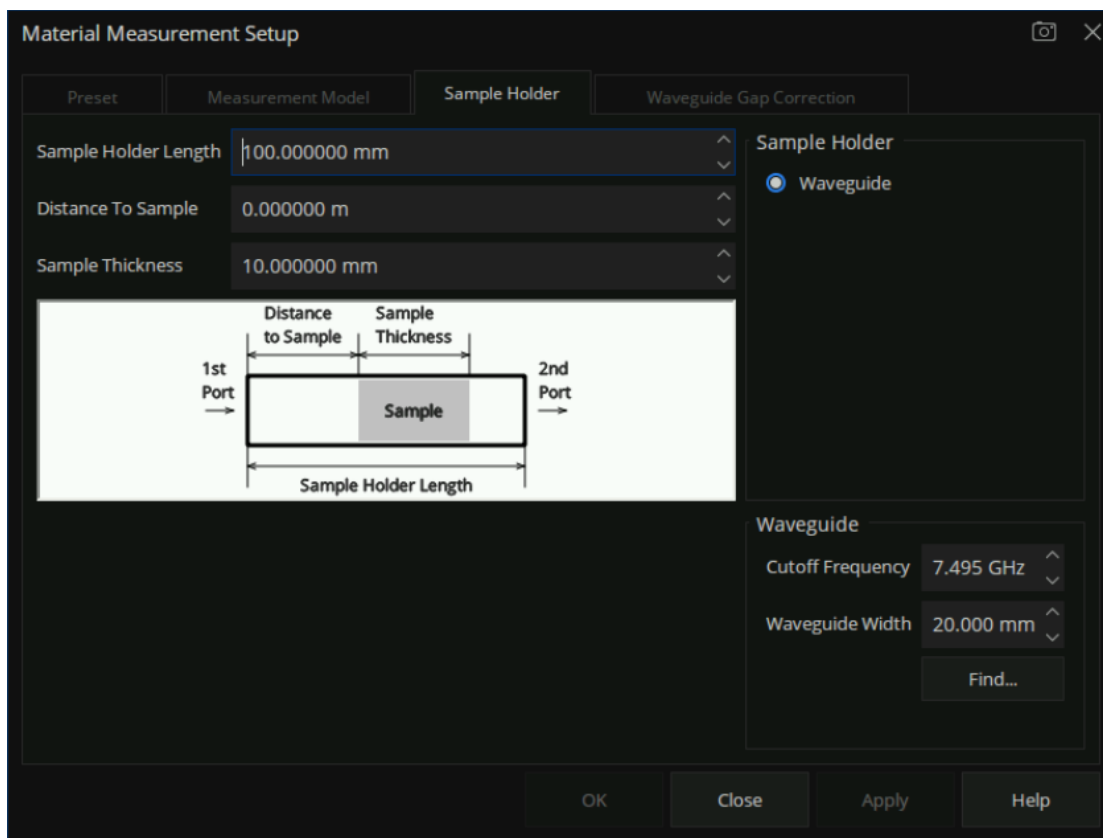

Figure 15-7 Sample Holder Tab

Sample Holder Length: Sets the length of the sample holder.

Distance To Sample: Sets the distance between the sample and the reference plane of the forward port.

Sample Thickness: Sample length.

Sample Holder: Select the sample holder.

- Waveguide: Waveguide model.

Waveguide: Waveguide-related parameter settings, you can use the Find... button to quickly set waveguide information.

- Cutoff Frequency: The cutoff frequency of the waveguide, which will be automatically calculated according to the waveguide width.
- Waveguide Width: Waveguide width.
- Find: Give the information of all optional waveguides, and select the corresponding waveguide item to quickly set the information of waveguides.

15.3.4 Waveguide Gap Correction Tab

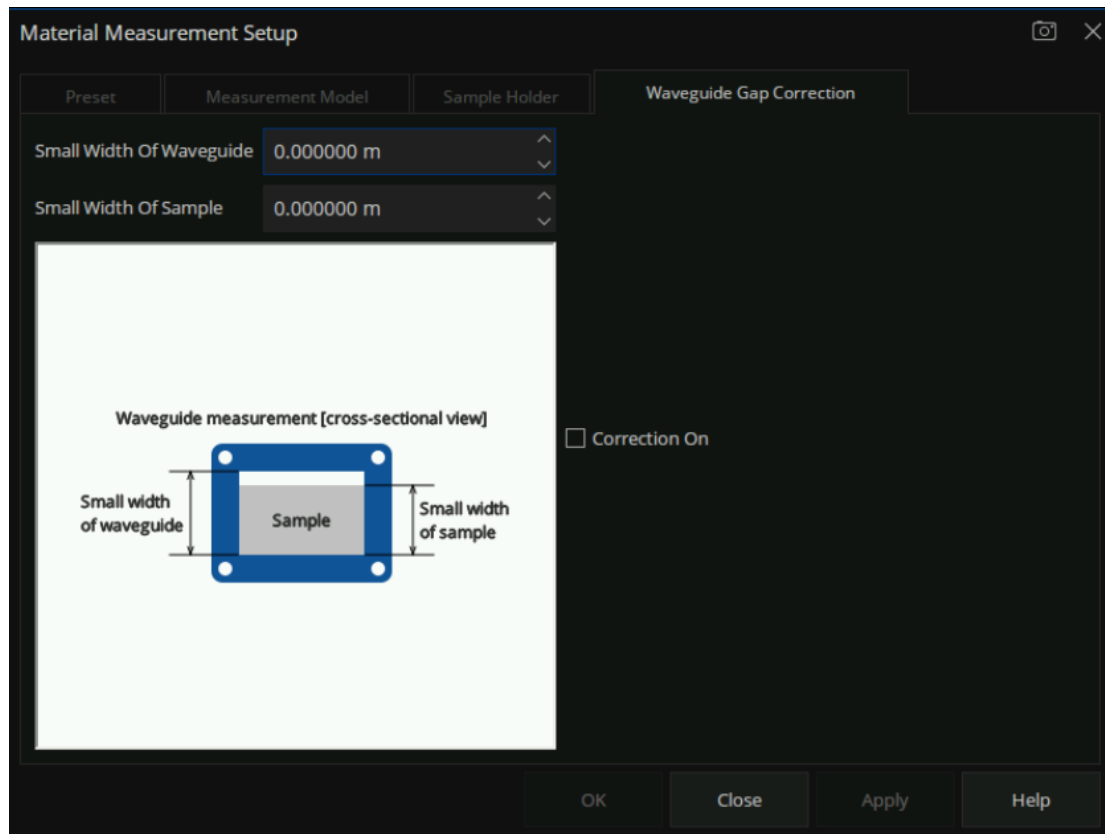

Figure 15-8 waveguide Gap Correction Tab

Small Width of Waveguide: Waveguide height.

Small Width of Sample: Sample height.

Correction On: After being checked, the calculation result is corrected according to the height information of waveguide and sample.

15.4 Waveguide TRL Calibration

Because the waveguide measurement needs an external adapter, it is necessary to calibrate the VNA and move the calibration reference plane to both ends of the waveguide coaxial adapter.

The two-port TRL calibration method does not need to know the index parameters of the calibration kit, and all the error items in the error model of the test device can be figured out through three simple connection methods. TRL calibration scheme will use the THRU straight through calibration element, reflection calibration kit (Open or Short), and a small section of transmission line.

Operating steps:

1. **Preset** vector network analyzer;
2. Switch to MATERIAL mode and set the corresponding waveguide holder, sweep points, power level and other parameters;
3. Select **Cal** → **Basic Cal** to enter the Settings screen, as shown in the figure below:

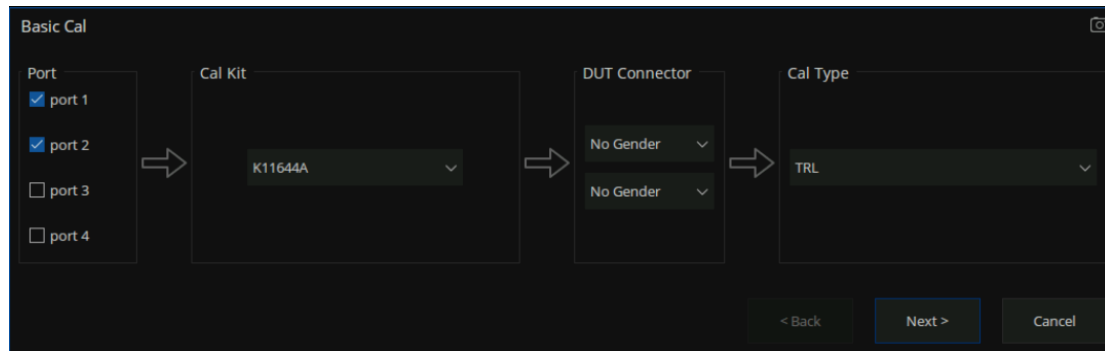

Figure 15-9 Calibration Wizard Interface

4. Select both **Port 1** and **Port 2**, select the required waveguide calibrator in **Cal Kit**, select **TRL** in the Cal Type, and click **Next** to proceed to the next step;



Figure 15-10 Calibration Wizard Interface

5. Connect waveguide coaxial adapters to Port1 and Port2 respectively, and the calibration plane A and the calibration plane B are directly connected together and fixed with screws. Click **Thru** to complete the through calibration of Port1 and Port2;

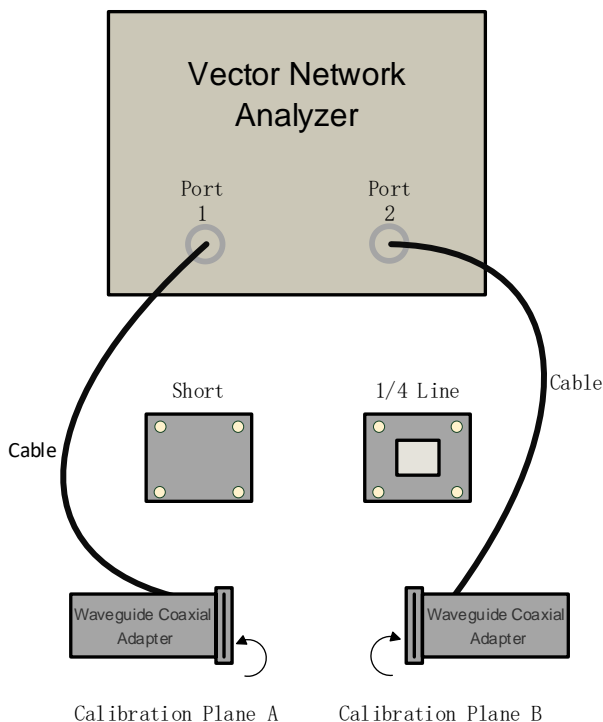

Figure 15-11 Schematic Diagram of Waveguide Calibration Connection

6. The calibration plane A is connected with the short calibration element, and fixed with screws. Click the **Reflect** item of Port1 to complete the reflection calibration of Port1;
7. The calibration plane B is connected with the short calibration element, and fixed with screws. Click the **Reflect** item of Port2 to complete the reflection calibration of Port2;
8. Connect the **1/4Line** calibration element between the calibration plane A and the calibration plane B, fix it with screws, and click the corresponding **Line** item to complete the calibration of Port1 and Port2 transmission lines;

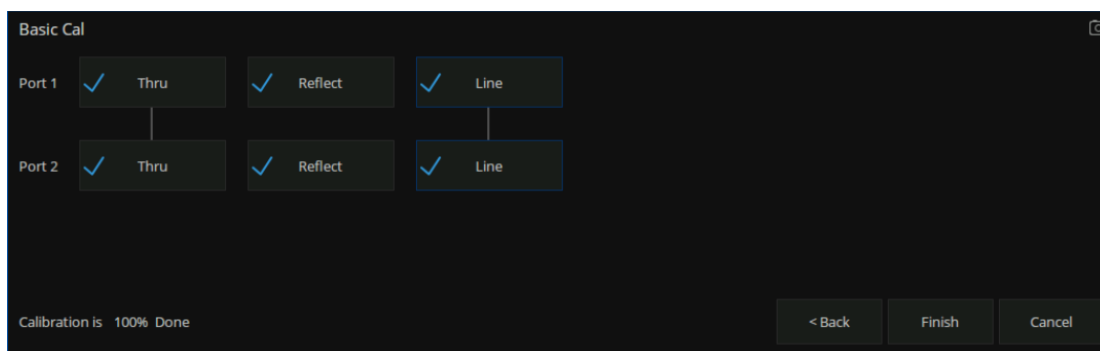

Figure 15-12 Calibration Wizard Interface

9. After the calibration, click **Finish** to exit the calibration interface, complete the calibration, and save the calibration data.

15.5 Sample Measurement

15.5.1 Sample Installation

Sample installation steps are as follows:

Load the sample into the waveguide from the waveguide port. Be careful when loading the sample to avoid sample damage. After loading, the plane of one side of the sample should be flush with the waveguide reference plane, as shown in the following figure:

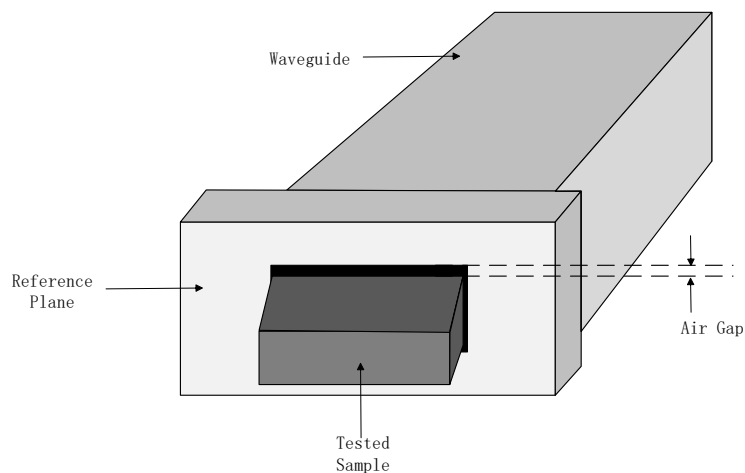

Figure 15-13 Schematic Diagram of Sample Installation

15.5.2 Sample Electromagnetic Parameter Measurement

The electromagnetic parameters of the tested sample are measured as follows:

1. In the material measurement mode, set parameters in the **Preset** tab interface, or you can quickly set related parameters through Quick Setting;
2. Calibrate the vector network analyzer;
3. Put the sample to be tested into the holder, and connect the sample holder to the calibration reference plane and fix it with screws, as shown in the following figure:

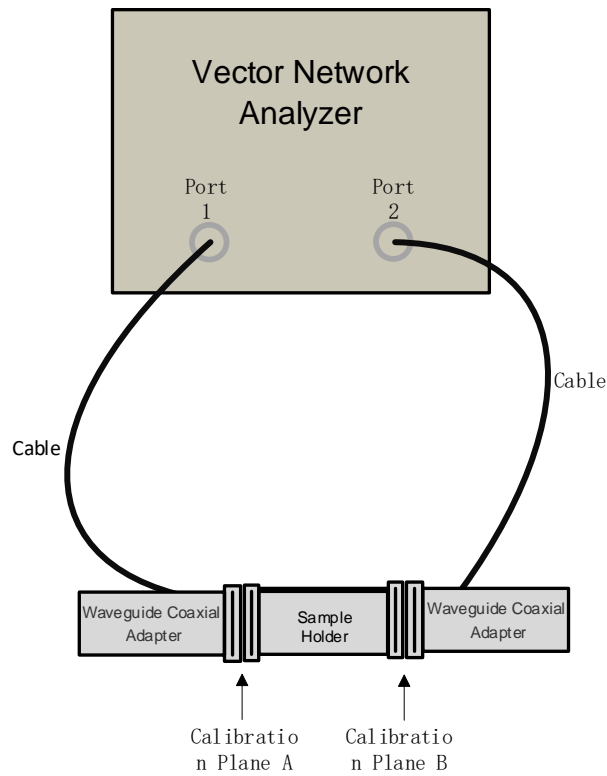

Figure 15-14 Schematic Diagram of Equipment Connection

4. Set Measurement Model and Calculate Type in the **Measurement Model** tab interface. If the Measurement Model is set to Ref/Tran ϵ Precision, you need to set the initial estimated value of permittivity;
5. Set the sample holder, sample and waveguide related parameters on the interface of **Sample Holder** tab and **Waveguide Gap Correction** tab;
6. When measuring the permittivity, set the measurement mode to ϵ and the data format to the Real. The measurement results are shown in the following figure:

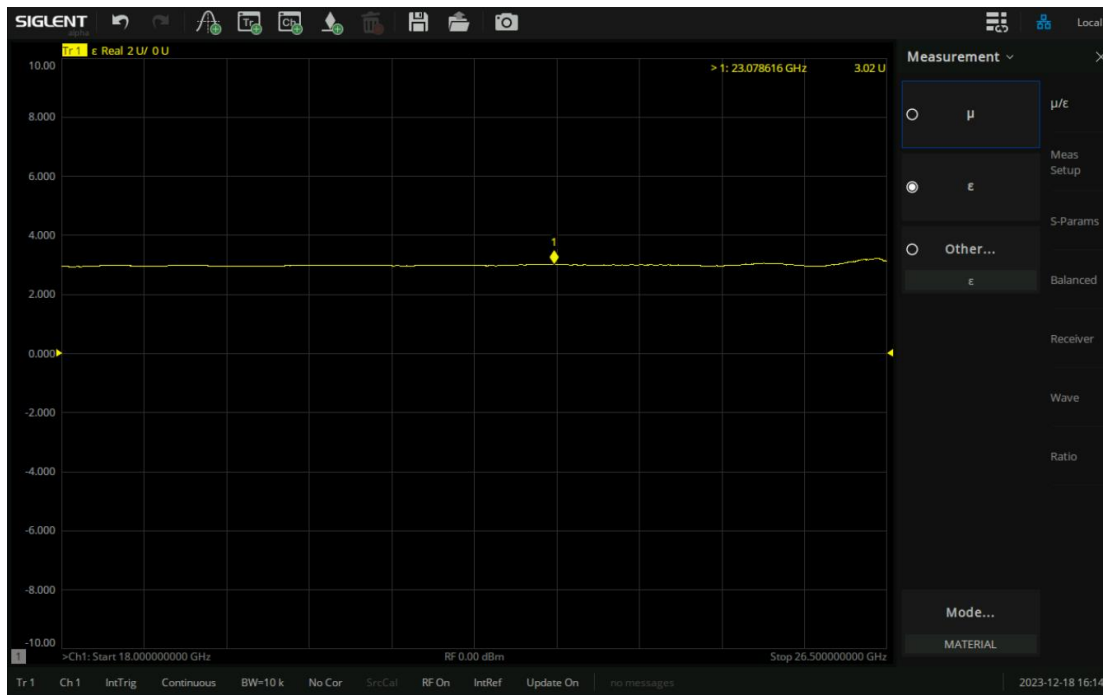

Figure 15-15 Permittivity Measurement Results (PEI Material)

7. When measuring magnetic permeability, the Measurement Model should be set to Ref/Tran μ & ϵ , the measurement mode should be set to μ , and the data format should be set to Real. The measurement results are shown in the following figure:

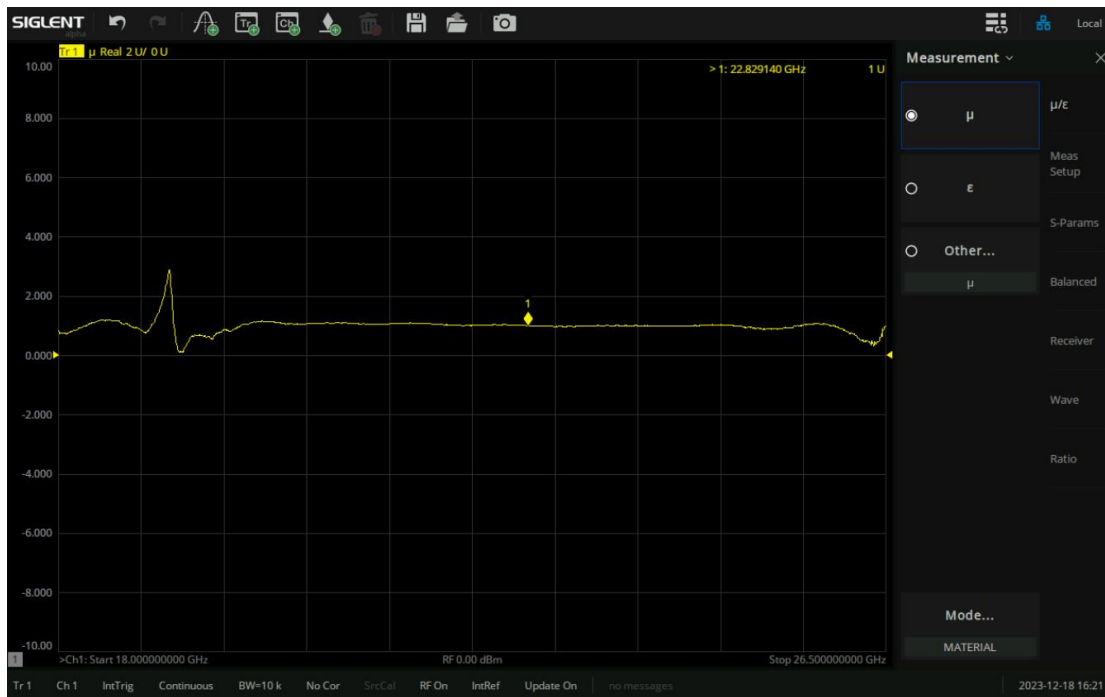

Figure 15-16 Permeability Measurement Results (PEI Material)

16 External Switch Matrices (SWM Option)

16.1 Overview

As the components used in modern communication devices must support more frequency bands and functions, such as the wide application of WLAN, Bluetooth and GPS, this means that the number of module RF ports is also increasing, while traditional vector network analyzers only have a maximum of four test ports, in order to measure multi-port devices, The test cable and termination load need to be changed several times between the various ports of the device under test (DUT) until all ports have been measured. And this will produce a lot of problems, such as: poor repeatability, complex operation, complex calculation is not intuitive and a series of problems. To satisfy multiple port scattering parameter tests at the same time, the number of ports of the vector network analyzer can be expanded by connecting external matrix switches that allow the external test device to be tightly integrated with the VNA itself. Generally called vector network analyzer port expansion device. With this extension device, an N-port network analyzer can be converted into an M-port network analyzer ($M > N$) without modifying the instrument itself. When making multi-port DUT measurements, multiple measurements can be made with a single connection, improving measurement speed, reliability and repeatability compared to traditional two/four-port VNA.

16.2 External Matrix switches Introduction

The firmware of the SNA6000A series is able to control switch matrices from SSM5000A directly. It is fast and easy to set up and operate a switch matrix via the graphical user interface. For example, an SNA6134A in combination with an SSM5144A can seamlessly work as a multipoint network analyzer with up to 24 ports. Greatly improve the test efficiency.

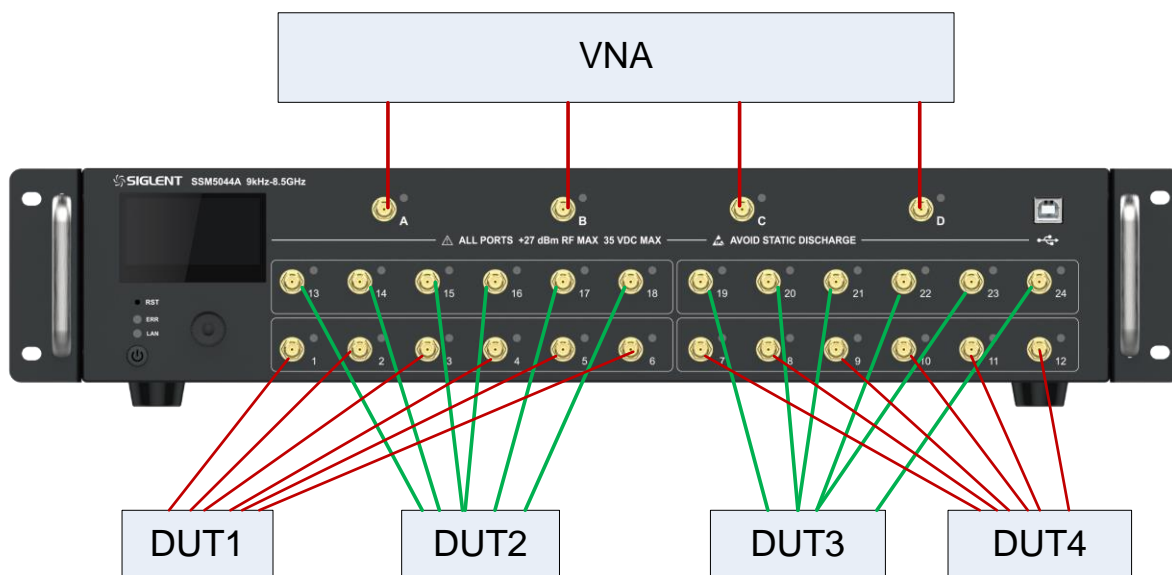

VNA and switch matrix combined expansion port diagram

16.3 Matrix setup step

16.3.1 Required equipment

Network vector analysis port expansion required equipment: SNA6000A, SSM5000A switch matrix, USB cable, several N-SMA/SMA RF cables. This chapter describes the VNA machines and switch matrix devices used by default SNA6134A and SSM5144A.

16.3.2 Establish the physical connection

1. Power on the SSM5144A and the SNA6134A, Connect the SSM5144A to the SNA6134A with a USB cable, and then a message of “The switch matrix plugged in” will displays on the SNA6134A message bar if the SSM5144 is recognized success.



2. Press the **System** > "External Ports" > "Ext Port Enabled" to enable the function, then the matrix identifier  is displayed on the upper right corner of the UI.

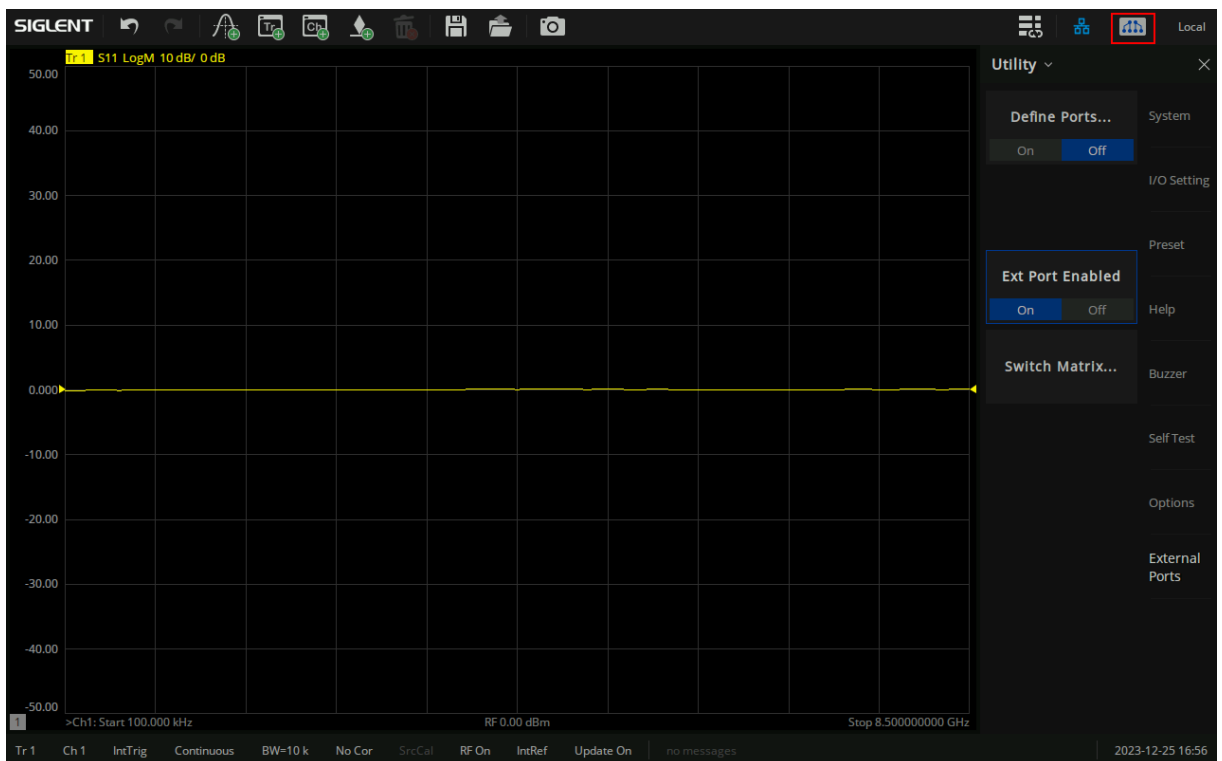

16.3.3 Define the RF configuration

After the VNA is physically connected to the SSM, Touch the “Switch Matrix...” menu to enter the “Switch Matrix RF connections” dialog box. This dialog allows you to define the RF connections between the VNA and the switch matrices, and the test port numbering, as picture below.

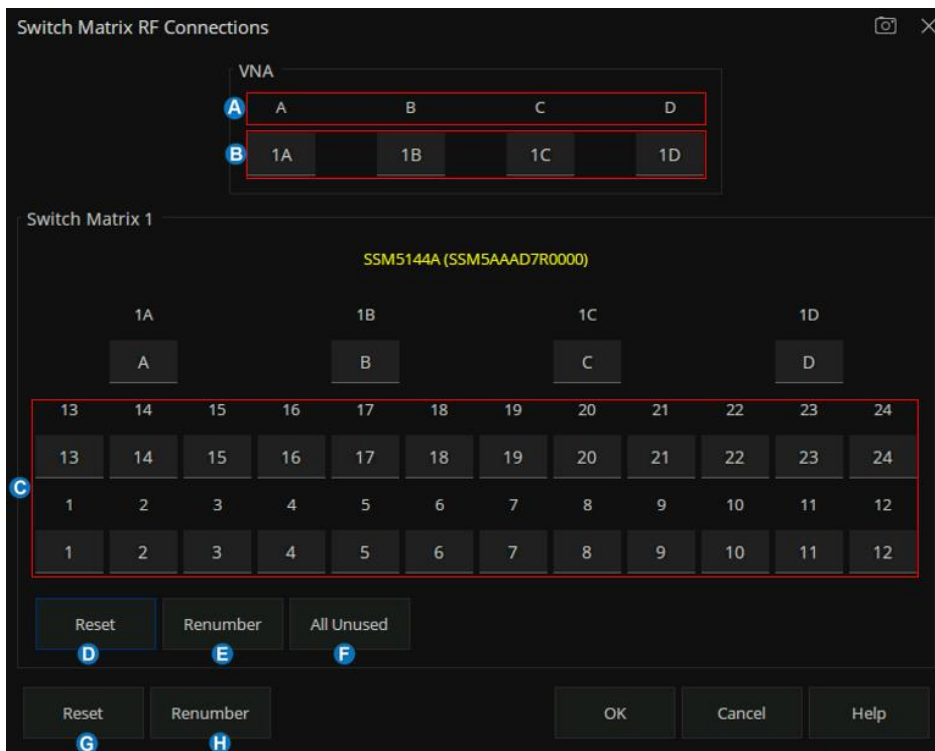

- A**: The A/B/C/D labels in the VNA check box indicate the four physical ports of the vector network analyzer port.
- B**: The edit box under the A/B/C/D label in the VNA selection box indicates that the RF input port of the SSM to be selected is connected to the VNA port for expansion. By default, physical Port1 (A) of the VNA connects to RF input port 1A of the SSM, physical port 2 (B) of the VNA connects to RF input port 1B of the SSM, physical port 3 (C) of the VNA connects to RF input port 1C of the SSM. And physical Port4 (D) of the VNA connects to RF input port 1D of the SSM. If you want to customize the RF Port connection between the VNA and the SSM, click the corresponding edit box under the A/B/C/D tab and select the port in the “Select Port” dialog box. As shown below:

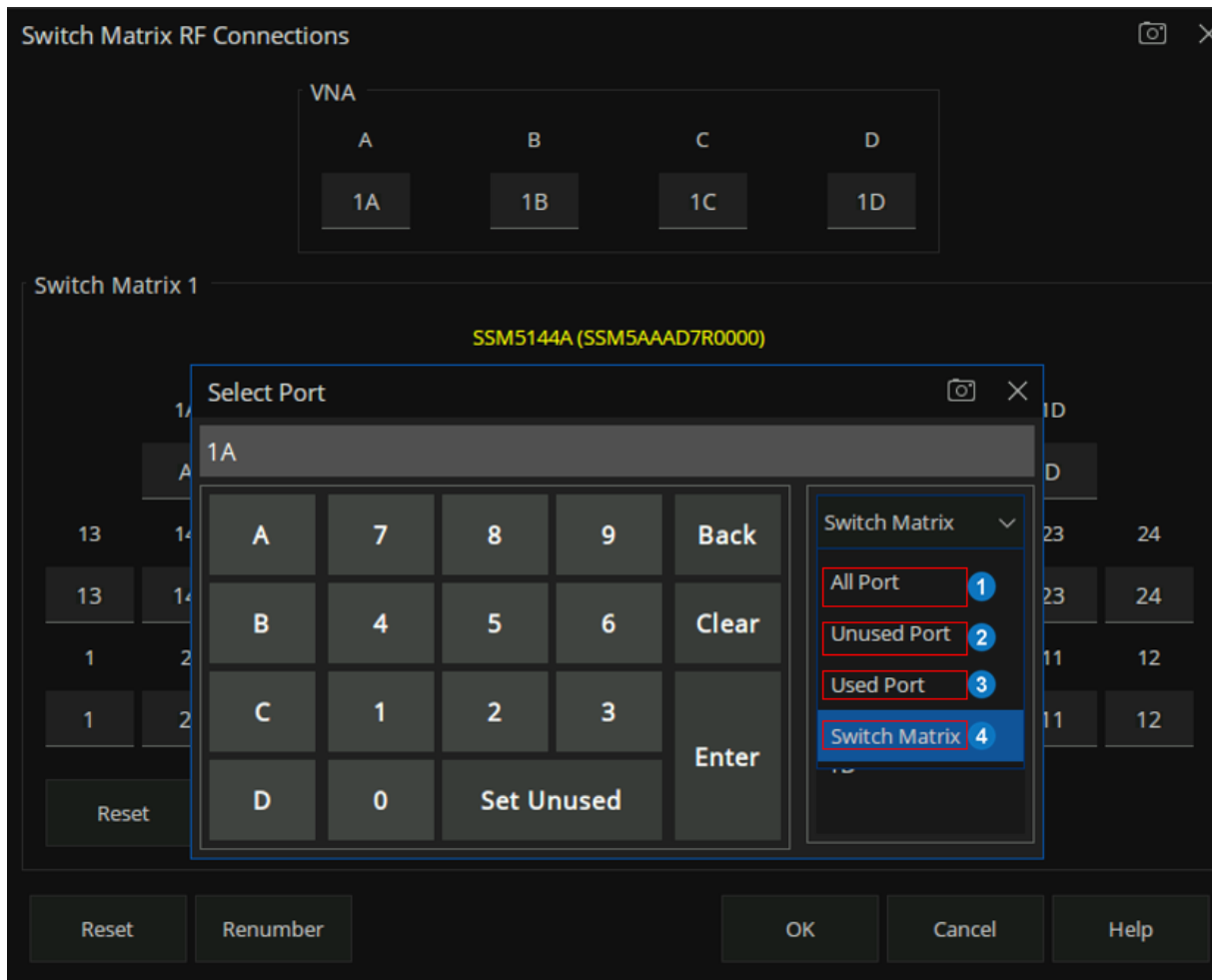

1 All Port: Indicates all RF ports (including VNA RF ports and SSM RF ports). You can select a port from the drop-down list.

2 Unused Port: Indicates an unused RF port number.

3 Used Port: Indicates the RF port number that is currently in use.

4 Switch Matrix: Indicates the RF input physical port number of the matrix switch. When a VNA is physically connected with two SSM, "1A" in the drop-down list of Switch Matrix represents the RF input port A of the first SSM, "2A" represents the RF input port A of the second SSM, and the same applies to 1B, 2B, 1C, 2C, 1D, 2D.

C: Represents the RF output port of the matrix switch.

D: the "Reset" in the Switch Matrix check box indicates that the default port number assignment is restored for the switch port of the matrix.

E: The “Renumber” under the Switch Matrix check box means to re-assign automatic port numbers to the switch matrix.

F: The “All Unused” under the Switch Matrix check box indicates that all RF ports of the switch matrix are set to unused (that is, no connection exists).

G: The “Reset” in Switch Matrix RF Connections restores the default port number assignment for all RF ports (including VNA RF ports and RF ports in the switch matrix).

H: The “Renumber” under the Switch Matrix RF Connections check box indicates automatic port number assignment for all RF switch ports (including VNA RF ports and RF ports of the switch matrix).

After the RF port configuration is completed, click the "ok" menu option to apply the VNA multi-port expansion. and then the expansion ports also can be selected in the function of Basic Calibration, Port Extension, Fixtures, Port power.

16.3.4 Setting S Parameters

After VNA port expansion takes effect, connect the SNA6134A's Port 1, port 2, port 3, and port 4 to the Ports A, B, C, D of the SSM5144A via RF cables (N-SMA). Press the **Meas** > **S-Params** > **Other...** to enter the parameter configuration dialog, user can customize the RF Port number from the Receiver Port and Source Port drop-down lists. For example, S0512 is select the “5” as the receiver port and the “12” as the source port, or click the "Edit..." under the Measure dialog box. To enter the input edit box, enter "0512", and select S0512.

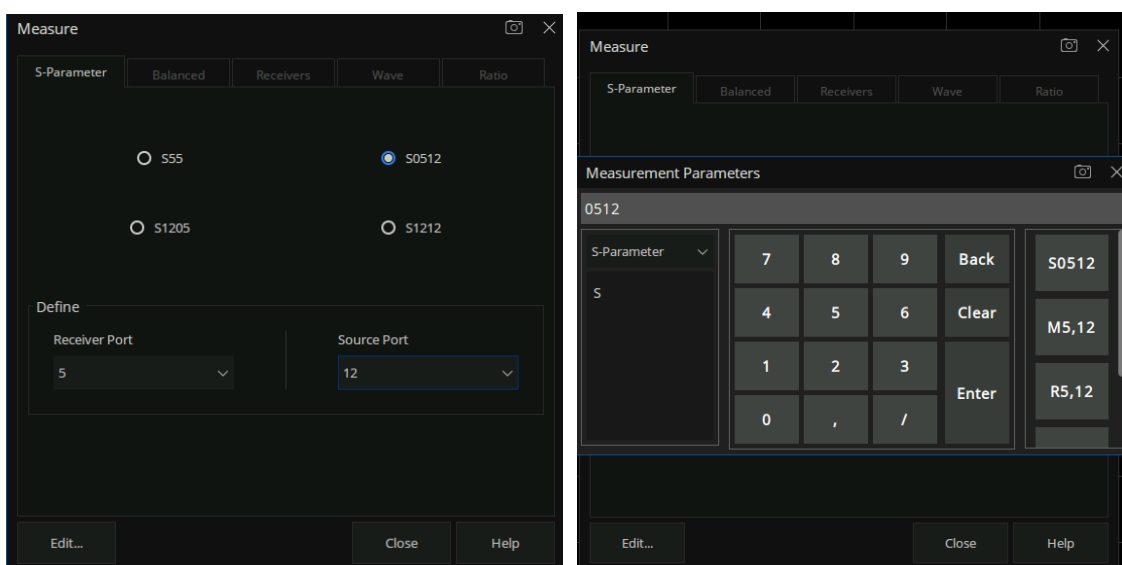

16.3.5 Calibrate and measure

After configure the S params, user can do the calibration by Ecal or by mechanical kit before measuring the DUT. The VNA expansion ports only supports the VNA measurement mode.

Note: In order to obtain more accurate measurement results, the DUT should be fully preheated before measuring.

Note: The machine should be fully preheated before measuring the DUT in order to obtain more accurate measurement results.

17 System setting

Press the **System** button on the front panel. We can set the IP address, set the date, restore the factory settings, consult the help document, set the buzzer, self-detection, language setting, obtain the software and hardware information of the device, and license management in the menu on the right side of the screen.

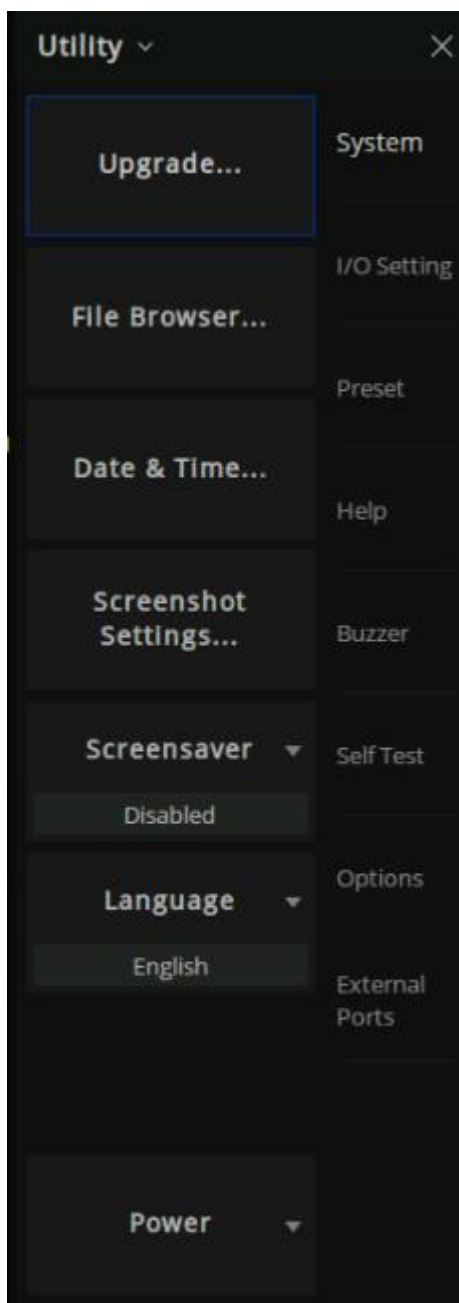

Figure 17-1 System setting interface

17.1 System Configuration

17.1.1 Firmware upgrade

Store the .ADS file in the firmware upgrade package downloaded from the official website in the U disk root directory, insert the U disk into the USB port of the vector network analyzer, click the **Upgrade** command in the **System** submenu, select the required file in the pop-up file browser, and click **OK** to upgrade the firmware. The firmware upgrade process may last for several minutes. When the upgrade is completed, the device will automatically restart. Any operation that interrupts the upgrade process may cause the upgrade to fail or even the device cannot start normally. Please keep the U disk stable and the power supply of the equipment normal during the firmware upgrade process.

17.1.2 File Browser

Click **File Browser** command to open the file browser, File management can be carried out in the file browser.

17.1.3 Date/Time setting

Use the **Date & Time** command in the **System** submenu to set the date/time. You can set whether to display the date/ time and display the format at the bottom right of the screen and modify the date/ time value.

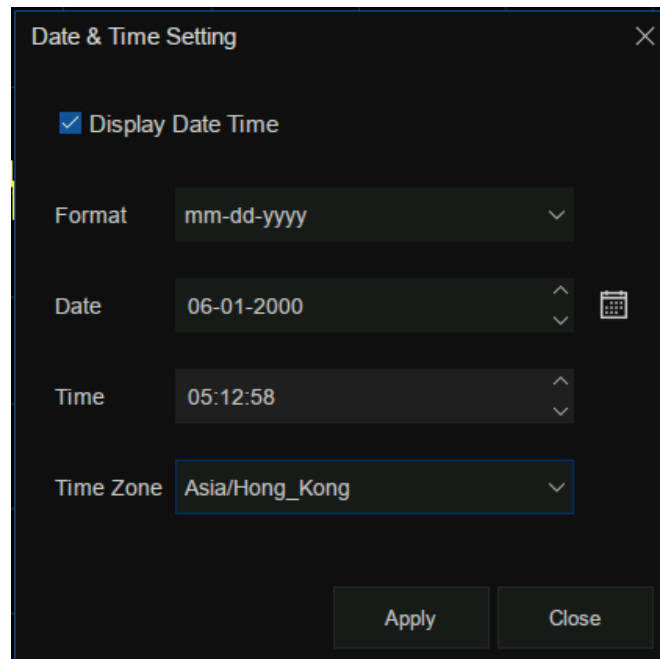

Figure 17-2 Date/Time setting interface

17.1.4 Screenshot setting

Use the **Screenshot Settings** command in the **System** submenu to set the screen capture parameters.

17.1.5 Screensaver

Use the **Screensaver** command in the **System** submenu to set the screen saver parameters.

17.1.6 System language

The **Language** command in the **Language** submenu can be used to change the language of the equipment. Simplified Chinese and English are supported.

17.1.7 Power

This menu provides shutdown and restart operation buttons.

17.2 Communication interface setting

17.2.1 LAN Status

We can select static or dynamic allocation of LAN-related parameters. Use LAN Status command in System submenu to set LAN parameters. The SNA6000A series supports dual port configuration, as shown in the following renderings:

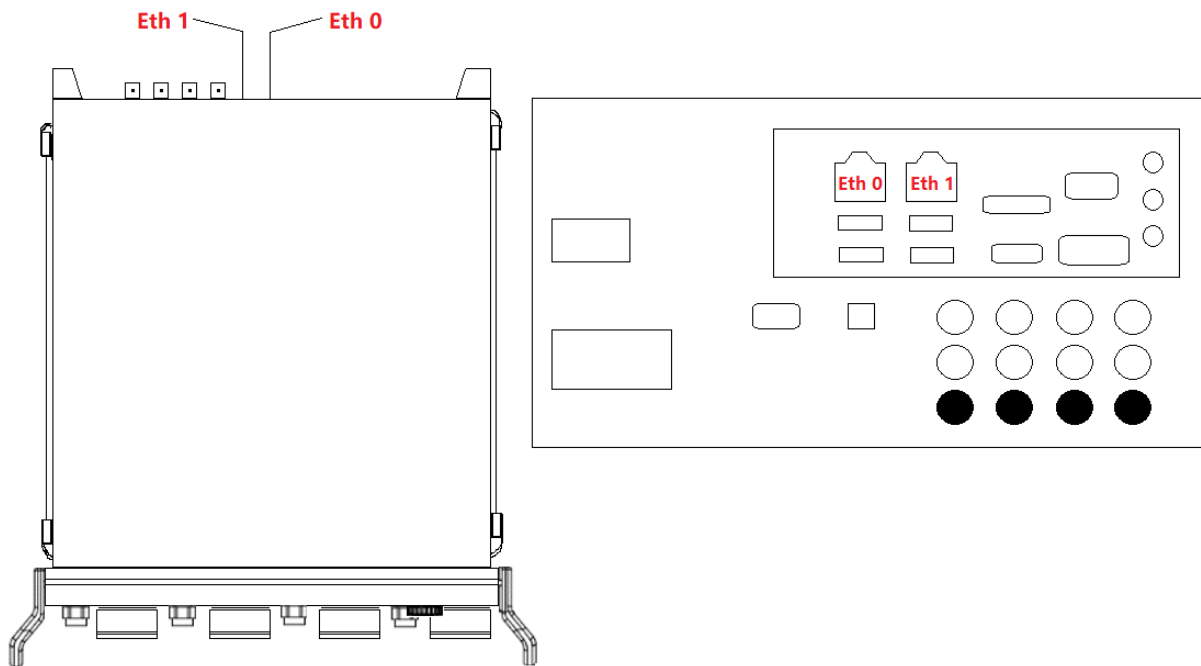

Figure 17-3 Vertical view and rear panel

17.2.2 mDNS Setting

The mDNS host name and description can be set in the **mDNS Setting** submenu.

The **Reset** menu button can restore the host name and description of mDNS to the default state.

17.2.3 LXI

You can view LXI related information in the **LXI** submenu.

17.2.4 VNC Setting

The analyzer supports VNC remote access to web pages. That is to say, the content displayed by the analyzer is projected to the web page remotely, and at the same time, the mouse and keyboard are supported to input parameters remotely.

The VNC port can be set in the **VNC Setting** submenu. When logging in to VNC, the port of VNC should be consistent with the set port.

The **Reset** menu button can restore the VNC port to the default state.

17.2.5 Web Setting

You can set the Web password in the **Web Setting** submenu, and you need to enter the web password when remotely controlling the analyzer through the web.

The **Reset** menu button can restore the Web password to the default state.

17.2.6 GPIB

Use the GPIB command in the System submenu to set the GPIB port number.

17.2.7 External Device

Displays information about external devices connected to the analyzer.

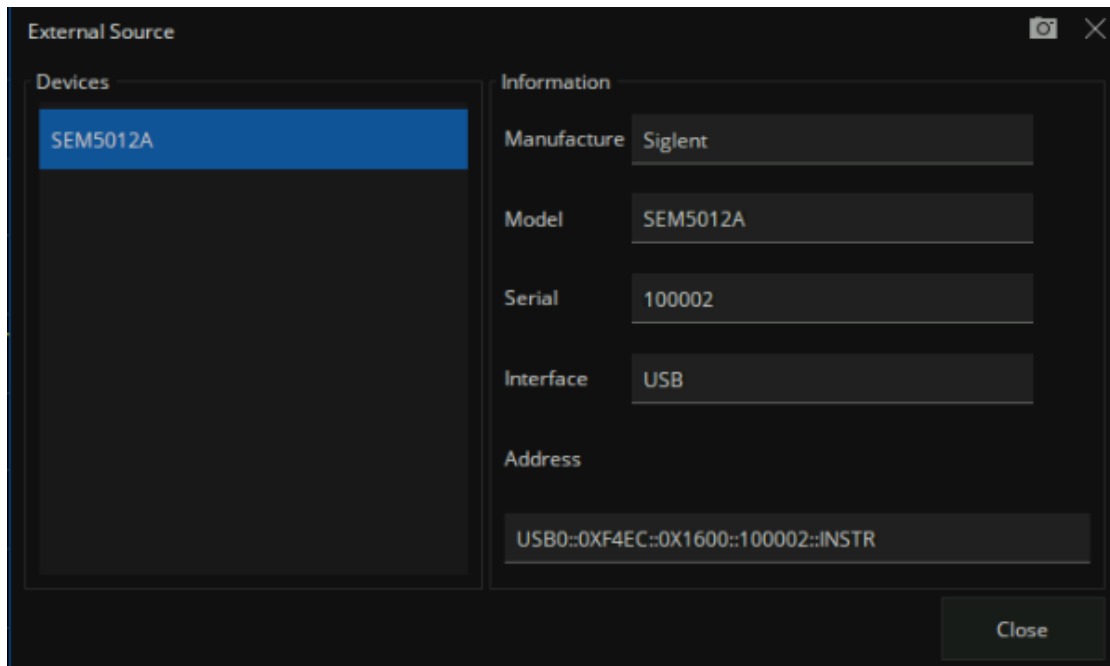

Figure 17-4 External device information display interface

17.3 Preset

Preset operation and related settings can be performed in Preset submenu.

Preset: Use the Preset command to reset immediately according to the setting reset options.

Preset Option: Use the Preset Option command to set the reset options, and to determine the preset source:

- **Default:** Load default parameters.
- **Last:** When the equipment is shut down, the current state will be saved automatically. Use this option to restore to the last shutdown state.
- **User:** Restore the equipment to the user-specified state.

User Preset: Use the User Preset command to specify the user preset status information file.

Confirm Preset: Use the Confirm Preset command to set whether to confirm before reset.

Power On Option: Use the Power On Option command to set the default source of equipment reset when the equipment starts.

17.4 Factory Reset

- **Configuration files** (Selected by default) Indicates that the equipment is restored to the factory default state, but the files saved by the user to local will not be deleted.
- **User data** (Optional), user can selectively delete the files saved to local.
- **Secure delete** (optional), If the check box is checked, the original data will be overwritten with random data, achieving the effect of permanent deletion, which may take a little longer. If the check box is not checked, the normal deletion mode will be used.

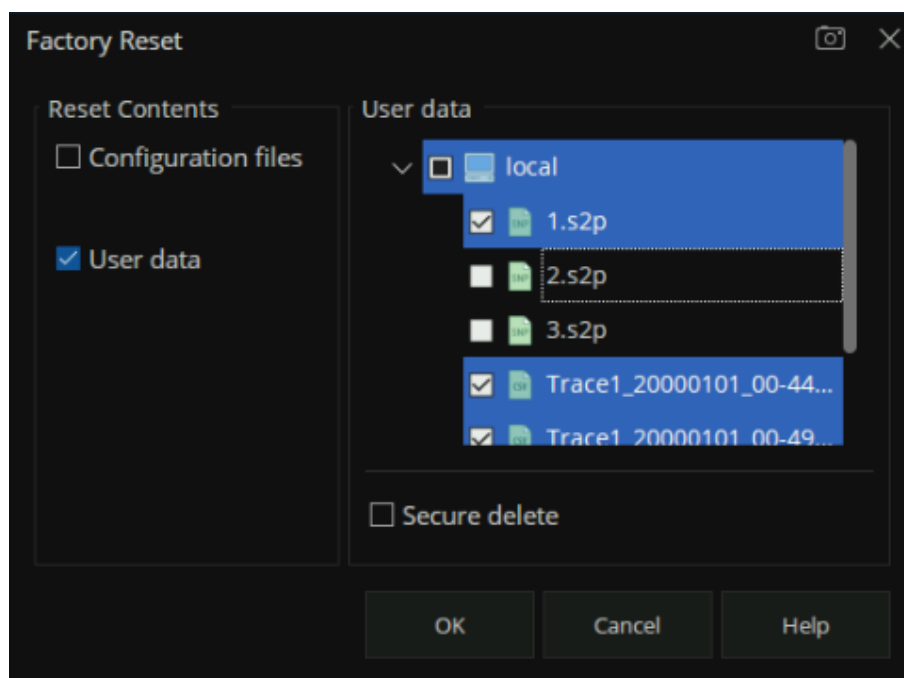

Figure 17-5 Select the saved file

- **Configuration files and User data** If user select both, the equipment is restored to the factory default state and deletes the files saved to local by users.

17.5 Help information

17.5.1 Help and About

In the Help submenu, we can open the help document (Help command) or view the equipment information (About command).

17.5.2 Message Setting

In the Message Setting submenu, we can open the message setting dialog.

- **Enable Message Display** (Selected by default) Check to display all messages as they occur. Clear to suppress the display of messages. You can still view them in the [View Message](#).
- **Enable Power Unlevel Detection** (Selected by default) Check to enable the power unlevel detection. Clear to close.

17.5.3 View Message

In the View Message submenu, we can open the message log dialog.

17.6 Buzzer

We can set the sound in the Buzzer submenu.

Buzzer: Use the Buzzer command to turn the device sound on or off.

Complete Test: Use the Complete Test command to test the completion tone.

Complete Buzzer: Use the Complete Buzzer command to turn the completion tone on or off.

Warning Test: Use the Warning Test command to test the alarm tone.

Warning Buzzer: Use the Warning Buzzer command to turn on or off the alarm tone.

Touch Buzzer: Use the Touch Buzzer command to turn on or off the touchscreen keystone.

17.7 Self-Test

17.7.1 Key and touch screen test

In the **Self Test** submenu, we can perform keyboard self-test (**Key Test** command), touch screen self-test (**Touch Test** command), screen self-test (**Screen Test** command) and LED self test (**LED Test** command).

17.7.2 Performance test

17.7.2.1 Enter VNA Test Dialog Method

Press the **Utility** key of front panel → **Self Test** → **Performance Verification...**

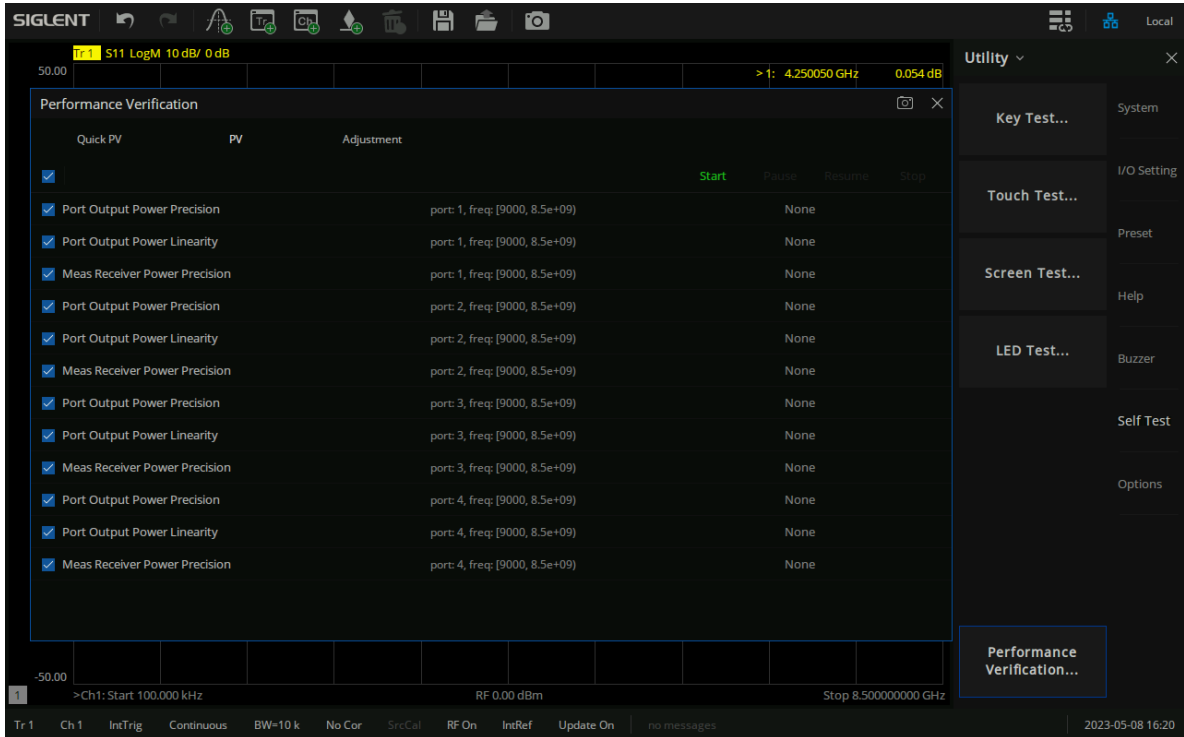

17.7.2.2 VNA Test Dialog UI Description

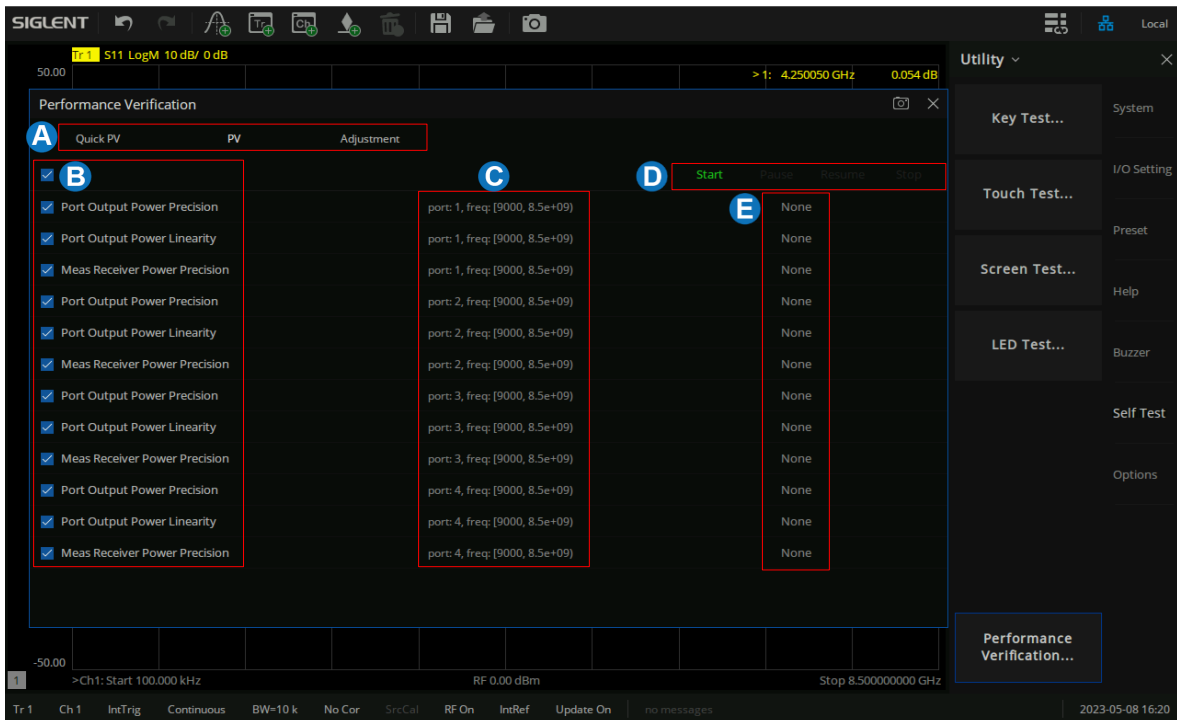

- A. Adjustment and PV mission area
- B. Detailed test item
- C. Test parameter
- D. Task Process control area
- E. Test result (Pass/Fail)

17.7.2.3 Task Process Description

SNA performance verification mainly includes Quick PV, PV and Adjustment.

17.7.2.3.1 Quick PV

Needed equipment:

- Calibration Kits (Short, Load)

Adjustment Process:

1. Enter Quick PV tab page
2. Select the test port

3. Connect the Calibration Kits to the port as prompted by the wizard
4. Click **Run** button to begin the PV test.

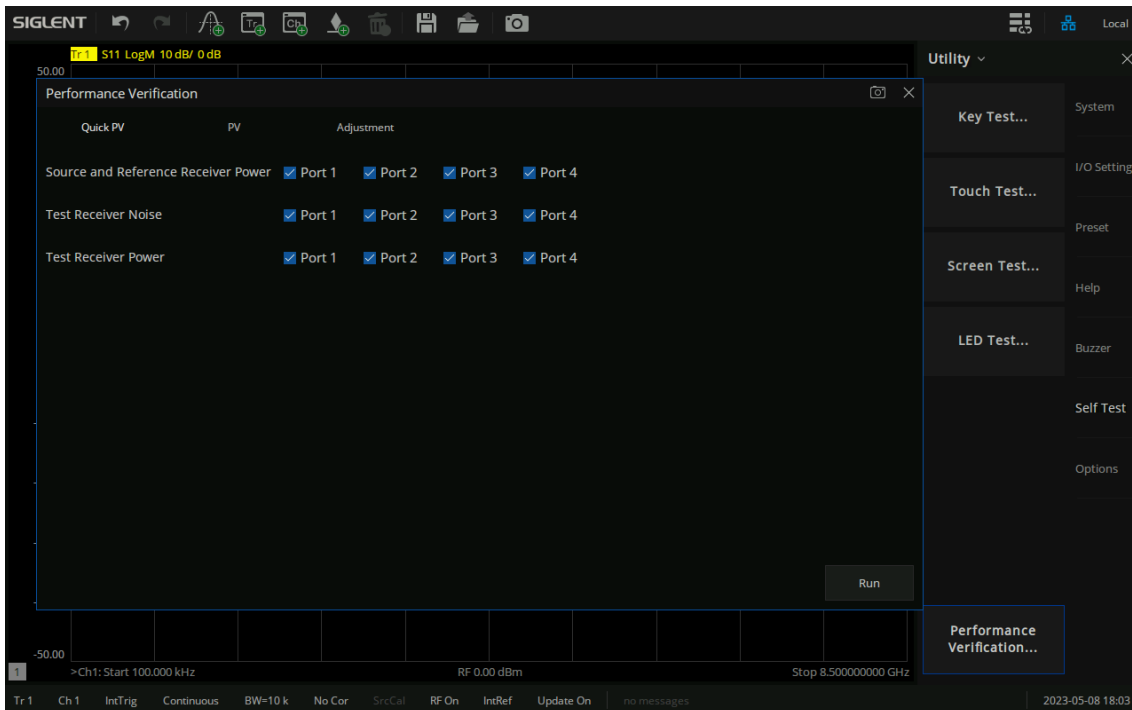

17.7.2.3.2 Adjustment Task

Needed equipment:

- Power Meter (The maximum frequency of the machine is less than 13.5GHz with R&S NRP18A, and greater than 13.5GHz with R&S NRP18A and R&S NRP33S)
- 10 dB attenuator × 1
- Coaxial cable × Several
- Calibration Kits (2-port machine: Open × 1+Short × 1+Load× 2; 4-port machine: Open × 1+Short × 1+Load × 4)
- Adapter × Several

Adjustment Process:

1. Enter adjustment tab page.
2. Select all calibration items.

3. Click **Start** button to begin adjustment tasks.
4. Follow the tips to complete the adjustment process.

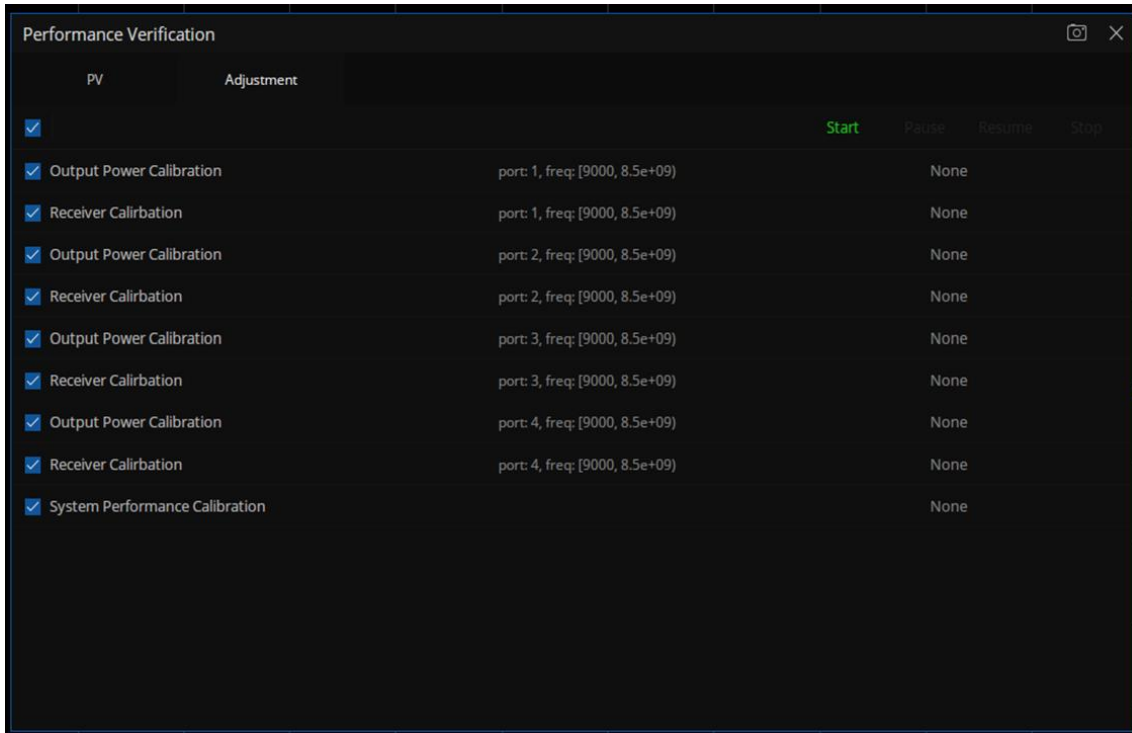

17.7.2.3.3 PV Task

Needed equipment:

- Power Meter (The maximum frequency of the machine is less than 13.5GHz with R&S NRP18A, and greater than 13.5GHz with R&S NRP18A and R&S NRP33S)
- Coaxial cable × Several
- Adapter × Several

PV Process:

1. Enter PV tab page.
2. Select all test items.
3. Click **Start** button to begin PV tests.
4. Follow the tips to complete the PV process.
5. Click test item **Export Report...** button to save the report. (Optional)

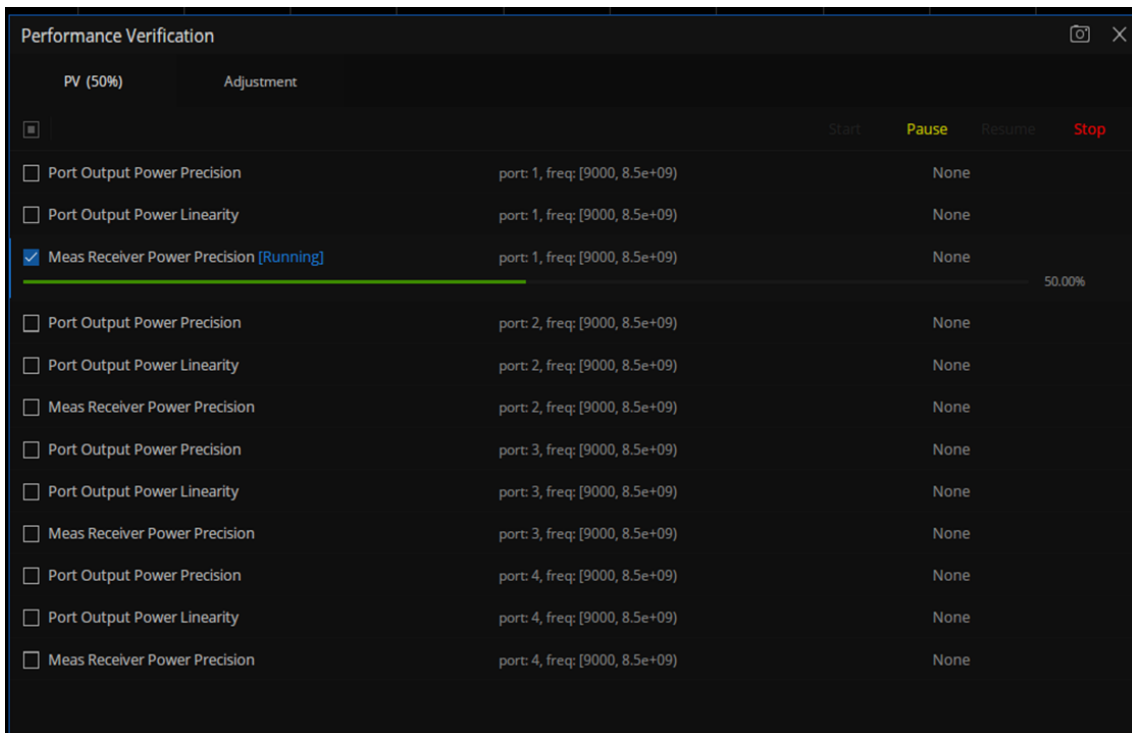

17.7.2.4 Switch to User Factory Calibration Data

Press the **Cal** key of front panel → **Cal** → **Factory Cal...**

Tips:

1. Factory mode, VNA use factory calibration data.
2. When the check box is checked, VNA will use user calibrated calibration data.
3. After the user performs factory calibration, this check box will be automatically selected.

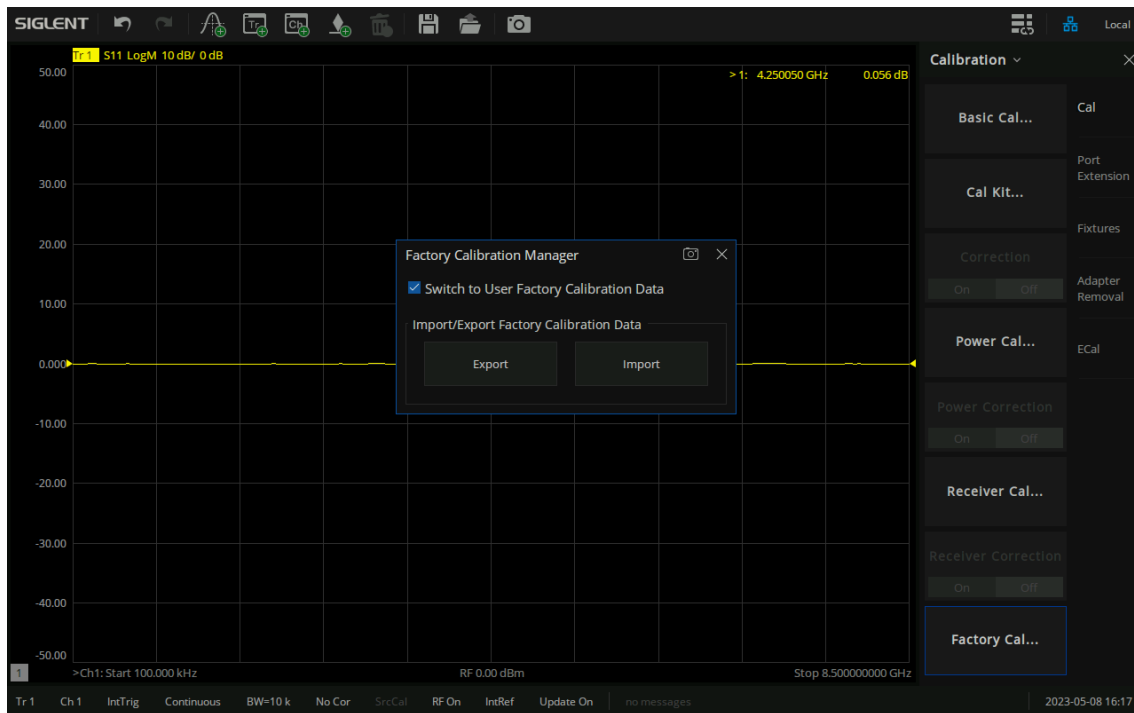

17.8 Options

Refer to the procedures below to activate the options you have purchased.

- 1 Press **System** > “Options”-> “License...”
- 2 Enter the license key in the onscreen window.

Press **Enter** to confirm your input and terminate the license key input. Or load the .lic file and press “Scan U-disk” to select the corresponding .lic file in the memory.

17.9 External Ports

Used to define external logical port, source port, reference receiver port and test receiver port.

18 Service and Support

18.1 Ordering and activating the options

There are two ways for you:

1. Pre-activate the options by SIGLENT factory.

If you order a instrument and options, SIGLENT factory will activate the options for you before delivery.

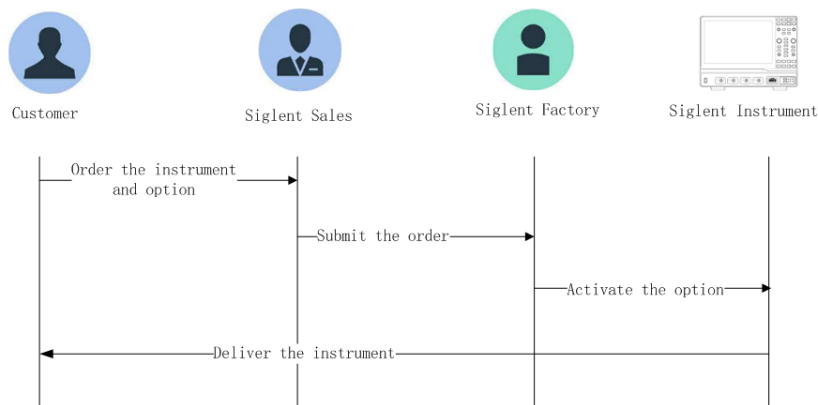

2. Post-activate the options by yourself.

If you want to activate options on a instrument that you are using.

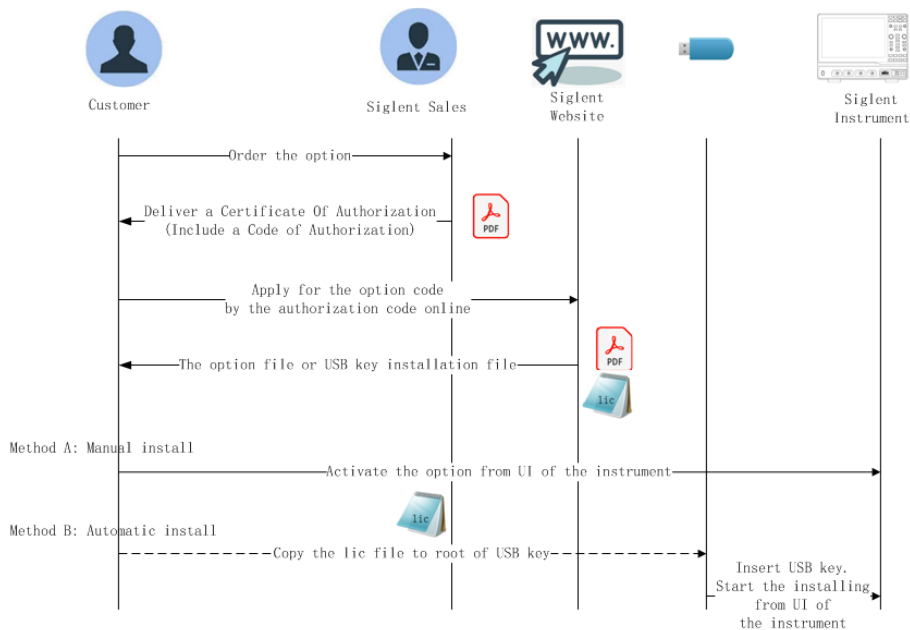

18.2 Warranty overview

SIGLENT guarantees that the products produced and sold will not have defects in materials and technology within three years from the date of delivery by authorized distributors. If the product is defective within the warranty period, **SIGLENT** will provide repair or replacement service according to the detailed provisions of the warranty.

For service or a complete copy of the warranty, please contact your nearest **SIGLENT** sales and service office. **SIGLENT** makes no other warranty, express or implied, except as provided in this summary or the applicable warranty, including but not limited to the implied warranty of merchantability and special applicability. **SIGLENT** shall not be liable for any indirect, special or consequential damages.

18.3 Contact SIGLENT

Headquarters:

SIGLENT Technologies Co., Ltd

Add: Bldg No.4 & No.5, Antongda Industrial Zone, 3rd Liuxian Road,
Bao'an District, Shenzhen, 518101, China

Tel: + 86 755 3688 7876

Fax: + 86 755 3359 1582

Email: sales@siglent.com

Website: int.siglent.com

North America:

SIGLENT Technologies America, Inc

6557 Cochran Rd Solon, Ohio 44139

Tel: 440-398-5800

Toll Free: 877-515-5551

Fax: 440-399-1211

Email: info@siglentna.com

Website: www.siglentna.com

Europe:

SIGLENT Technologies Germany GmbH

Add: Staetzlinger Str. 70

86165 Augsburg, Germany

Tel: +49(0)-821-666 0 111 0

Fax: +49(0)-821-666 0 111 22

Email: info-eu@siglent.com

Website: www.siglenteu.com



About SIGLENT

SIGLENT is an international high-tech company, concentrating on R&D, sales, production and services of electronic test & measurement instruments.

SIGLENT first began developing digital oscilloscopes independently in 2002. After more than a decade of continuous development, SIGLENT has extended its product line to include digital oscilloscopes, isolated handheld oscilloscopes, function/arbitrary waveform generators, RF/MW signal generators, spectrum analyzers, vector network analyzers, digital multimeters, DC power supplies, electronic loads and other general purpose test instrumentation. Since its first oscilloscope was launched in 2005, SIGLENT has become the fastest growing manufacturer of digital oscilloscopes. We firmly believe that today SIGLENT is the best value in electronic test & measurement.

Headquarters:

SIGLENT Technologies Co., Ltd
Add: Bldg No.4 & No.5, Antongda Industrial
Zone, 3rd Liuxian Road, Bao'an District,
Shenzhen, 518101, China
Tel: + 86 755 3688 7876
Fax: + 86 755 3359 1582
Email: sales@siglent.com
Website: int.siglent.com

North America:

SIGLENT Technologies America, Inc
6557 Cochran Rd Solon, Ohio 44139
Tel: 440-398-5800
Toll Free: 877-515-5551
Fax: 440-399-1211
Email: info@siglentna.com
Website: www.siglentna.com

Europe:

SIGLENT Technologies Germany GmbH
Add: Staetzlinger Str. 70
86165 Augsburg, Germany
Tel: +49(0)-821-666 0 111 0
Fax: +49(0)-821-666 0 111 22
Email: info-eu@siglent.com
Website: www.siglenteu.com

Follow us on
Facebook: [SiglentTech](https://www.facebook.com/SiglentTech)

