
Service Manual

SDS2000X Series Digital Oscilloscope

Guaranty and Declaration

Copyright

SIGLENT TECHNOLOGIES CO., LTD All Rights Reserved.

Trademark Information

SIGLENT is the registered trademark of **SIGLENT TECHNOLOGIES CO., LTD**

Declaration

- **SIGLENT** products are protected by patent law in and outside of P.R.C.
- **SIGLENT** reserves the right to modify or change parts of or all the specifications or pricing policies at company's sole decision.
- Information in this publication replaces all previously corresponding material.
- Any method of copying, extracting or translating the contents of this manual is not allowed without the permission of **SIGLENT**.
- **SIGLENT** will not be responsible for losses caused by either incidental or consequential reasons in connection with the furnishing, use or performance of this manual as well as any information contained.

Product Certification

SIGLENT guarantees this product conforms to the national and industrial standards in China as well as the ISO9001: 2008 standard and the ISO14001: 2004 standard. Other international standard conformance certification is in progress.

General Safety Summary

Review the following safety precautions to avoid personal injuries and prevent damages to this product or any products connected to it. To avoid potential hazards, use this product only as specified.

Only qualified personnel should perform service procedures.

To Avoid Fire or Personal Injuries

Use Proper Power Cord. Use only the power cord specified for this product and approved by your local governing agencies.

Avoid Electric Shock. To avoid injuries or potential loss of life, do not connect or disconnect probes or test leads while they are connected to a voltage source.

Ground the Product. This product is grounded through the protective ground conductor of the power line. To avoid electric shock, the grounding conductor must be connected to the earth ground. Make sure the instrument is grounded correctly before connecting its input or output terminals.

Connect the Probe Properly. Do not connect the probe ground lead to a high voltage since it has the isobaric electric potential as ground.

Observe All Terminal Ratings. To avoid fire or shock hazard, observe all ratings and markings on the instrument and check your manual for more information about ratings before connecting.

Use Proper Fuse. Use only the specified fuse.

Do Not Operate Without Covers. Do not operate this instrument with covers or panels removed.

Avoid Circuit or Wire Exposed. Do not touch exposed junctions and components when the unit is powered.

Do Not Operate With Suspected Problems. If you suspect damage has occurred to this instrument, have it inspected by qualified service personnel before further operation. Any maintenance, adjustment or replacement, especially to the circuits or accessories should be performed by SIGLENT authorized personnel.

Keep Product Surfaces Clean and Dry.

Do Not Operate in Wet/Damp Conditions. To avoid electric shock, do not operate the instrument in wet or damp conditions.

Do Not Operate in an Explosive Atmosphere. To avoid injuries or fire hazards, do not operate in an explosive atmosphere.

Safety Terms and Symbols

Terms on the Product. These terms may appear on the product:

DANGER: Indicates an injury or hazard that may immediately happen.

WARNING: Indicates an injury or hazard may be potentially accessible.

CAUTION: Indicates damage to the instrument or other property may occur.

Symbols on the Product. These symbols may appear on the product:



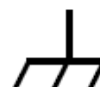
Hazardous Voltage



Refer to Instructions



Protective Earth Terminal



Chassis Ground



Test Ground

Contents

Guaranty and Declaration	I
General Safety Summary	II
General Features	3
General Features	3
Prepare Information	6
Functional checking	6
Power-on Inspection.....	6
Probe Compensation	8
Auto Setup.....	9
Self Calibration	10
Interface Test.....	12
USB Host Test.....	12
USB Device Test.....	13
LAN Port Test	14
Pass/Fail out Test.....	16
Performance Test	18
To Verify DC Gain Accuracy	23
To Verify Offset Accuracy.....	25
To Verify Time Base Accuracy.....	27
To Verify Trigger Delay	28
To Verify Ext Trigger Delay.....	29
To Verify Ext Trigger Level	30
To Verify Noise Floor.....	31
To Verify Bandwidth	32
To Verify Bandwidth Limit	34
To Verify Trigger Sensitivity.....	35
To Verify Input Impedance.....	37
To Verify AWG.....	38
Adjusting Procedures	40
Warming Up.....	40
Self Calibration	40
Required Equipment	40
Software Installation	41
Adjusting Steps	41
Assembly Procedures.....	44
Security Considerations	44
List of Modules	44
Required Tools	45
Disassembly Procedures.....	46
Removing the Front-Panel Knobs.....	46
Removing the Rear Panel.....	47
Removing the Rear Metal Cover.....	49
Removing the Front Panel.....	50
Removing the LCD, Channel Board and Keyboard.....	51
Removing the Main Board	52
Troubleshooting Hardware Failures	54
ESD Precautions.....	54
Required Equipment.....	54
Main Board Drawing.....	55
Troubleshooting Flowchart	56
Check the Power Supply	58
Check the Main Board	59
Check the Display Module.....	60

SIGLENT

Handling General Hardware Failures.....	61
Contact SIGLENT.....	62

General Features

General Features

SIGLENT's SDS2000X series Super Phosphor Oscilloscopes are available in bandwidths of 70 MHz, 100 MHz, 200 MHz and 300 MHz, utilize a maximum sample rate of 2 GSa/s and a maximum record length of 140 Mpts. The most commonly used functions can be accessed with its user-friendly one-button design.

The SDS2000X series employs a new generation of SPO technology. It employs an innovative digital trigger system with high sensitivity and low jitter. The maximum waveform capture rate is 140,000 wfm/s (normal mode) and up to 500,000 wfm/s (sequence mode). It also employs not only the more-common 256-level intensity grading display function but also a powerful color temperature display mode. The SDS2000X's trigger system supports multiple powerful triggering modes including serial bus triggering. History waveform recording and sequence acquisition allow for extended waveform records to be captured, stored, and analyzed. An impressive array of measurement and math capabilities, options for a built-in 25 MHz arbitrary waveform generator, 16 digital channels (MSO), as well as serial decoding are also features of the SDS2000X.

Table 1 General features

Model	Bandwidth	Sampling Rate	Memory Depth	Channel
SDS2072X	70 MHz	2 GS/s	140 Mpts	2
SDS2074X	70 MHz	2 GS/s	140 Mpts	4
SDS2102X	100 MHz	2 GS/s	140 Mpts	2
SDS2104X	100 MHz	2 GS/s	140 Mpts	4
SDS2202X	200 MHz	2 GS/s	140 Mpts	2

SIGLENT

SDS2204X	200 MHz	2 GS/s	140 Mpts	4
SDS2302X	300 MHz	2 GS/s	140 Mpts	2
SDS2304X	300 MHz	2 GS/s	140 Mpts	4

- 70 MHz, 100 MHz, 200 MHz, 300 MHz models
- Real-time sampling rate up to 2 GSa/s
- New generation of SPO technology
 - Waveform capture rate up to 140,000 wfm/s (normal mode), and 500,000 wfm/s (sequence mode)
 - Supports 256-level intensity grading and color temperature display
 - Record length up to 140 Mpts
 - Digital trigger system
- Intelligent trigger: Edge, Slope, Pulse, Window, Runt, Interval, Dropout, Pattern and Video (HDTV supported)
- Serial bus triggering and decode, supports protocols IIC, SPI, UART, RS232, CAN, LIN
- Low background noise, supports 1 mV / div to 10 V / div voltage scales
- 10 types of one-button shortcuts; supports Auto Setup, Default Setup, Cursor, Measure, Roll, History, Persist, Clear Sweep, Zoom and Print
- Segmented acquisition (Sequence) mode. Divides the maximum record length into multiple segments (up to 80,000), according to trigger conditions set by the user - with a very small dead time segment - to capture the qualifying event
- History waveform record (History) function. The maximum recorded waveform length is 80,000 frames
- 37 automatic measurement functions. Supports Statistics calculations, Gating measurement, Math measurement, History measurement, Ref measurement
- Waveform math function (FFT, addition, subtraction, multiplication, division, integration, differentiation, square root)
- High Speed hardware-based Pass/ Fail function
- 25 MHz DDS arbitrary waveform generator - built-in 10 waveform functions (Optional)

- Large 8 inch TFT-LCD display with 800 * 480 resolution. Multiple interfaces, including USB Host, USB Device (USBTMC), LAN (VXI-11), Pass / Fail, Trigger Out
- Supports SCPI remote control commands
- Supports Multi-language display and embedded online help

Prepare Information

Before initiating performance verification or any adjustments, it is recommended the user follow these procedures. The following topics are discussed in this chapter.

- How to perform functional checks
- How to operate four standard interface tests
- How to use self-calibration routine
- How to recall factory Default settings

For more detailed information about oscilloscope operation, please refer to the Quick Start Guide.

Functional checking

The functional checking details three types of checks used to determine if the oscilloscope is operating properly.

Power-on Inspection

The normal operating voltage for the SDS2000X series digital oscilloscope is in range of 100-240 VRMS ,50 Hz/ 60 Hz/ 440Hz. Connect the power cord to the socket on the rear panel of the oscilloscope.

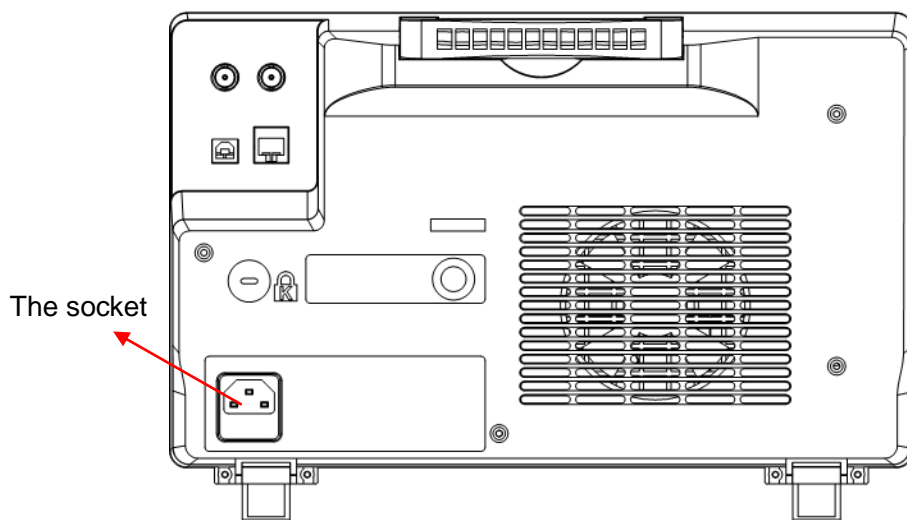


Figure 1 Connect power cord

Note: To avoid electric shock, make sure that the instrument is correctly grounded to the earth before connecting AC power.

Press the power-on button located at the lower left corner of the front panel and note that several oscilloscope keys will be lighted for about 6 seconds simultaneously, until the boot screen appears. The oscilloscope will then begin to perform its power-on tests automatically, after which the DEFAULT SETUP button can be pressed in order to recall the factory default settings.

Probe Compensation

It is necessary to compensate the probe at first use so as to properly match the probe to the oscilloscope's input channel. Non-compensated or poorly compensated probes may cause measurement inaccuracies or errors. The probe compensation steps are as follows:

1. Set the attenuation switch on the probe to 10X.

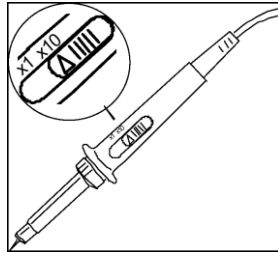
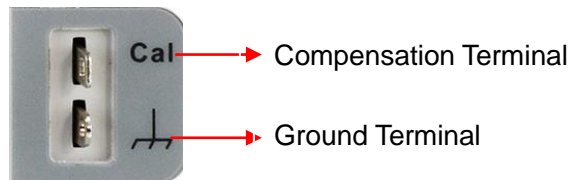
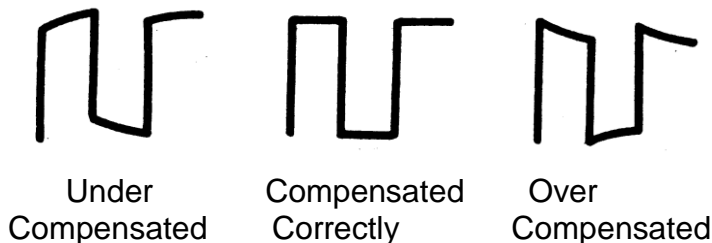


Figure 2 Set the attenuation switch

2. Connect the alligator clip of the probe to the Ground Terminal on the front panel, and then use the probe to connect CH1 BNC input connector to the Compensation Signal Output Terminal.



3. Press AUTO Setup.
4. Observe waveform on the screen. The displaying should be a square waveform as shown in the figure below:

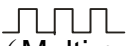






5. If the waveform does not show as “compensated correctly”, use a nonmetallic screwdriver to adjust the low-frequency compensation adjustment hole on the probe until the waveform displays correctly.

Auto Setup

Press the **Auto Setup** key to enable the waveform auto setting function. The oscilloscope will automatically adjust the horizontal time base, vertical scale and trigger mode according to the input signal to obtain an optimum waveform display.

Table 2 Auto setting menu

Option	Introduction
 (Multi-cycle sine)	Display several waveform cycles
 (Single-cycle sine)	Display single waveform cycles
 (Rising edge)	Display the rising edge of waveform
 (Falling edge)	Display the falling edge of waveform
 (Undo Setup)	Recall the previous setup of oscilloscope

- The input signal frequency must be higher than 20 Hz, with the amplitude greater than 8 mV.
- Select the channel with the lowest frequency when several channels are connected to signals.

Self Calibration

The self-calibration routine can quickly adjust the oscilloscope to perform at the optimum state in order to achieve the maximum accuracy. Self-calibration can be performed at any time, especially when a change in the ambient temperature of 5°C or more has occurred. Make certain that the oscilloscope has been warmed up or operated for more than 30 minutes before performing the self-calibration.

Use the following steps to perform self calibration:

1. Disconnect all leads from all input channels.
2. Press the **Utility** button on the front panel, and then press the **Do Self Cal** softkey. The oscilloscope will display the message box as shown below:

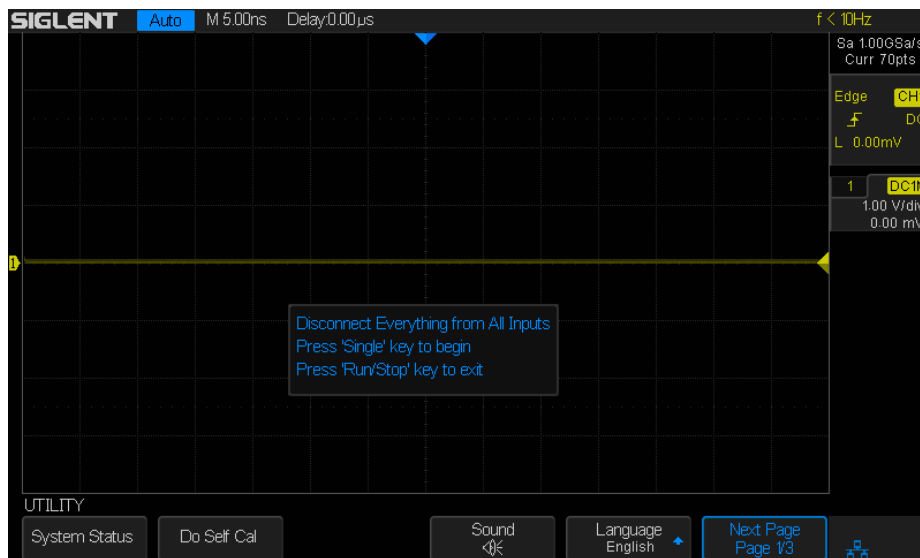


Figure2-3 Calibration Interface

3. Press the **Single** button on the front panel to perform the self calibration program. During the calibration, most of the oscilloscope's keys are disabled.
4. When the self calibration process is completed, the following message will appear: "**Press Run/Stop key to exit**". Press the **Run/Stop** button on the front panel to exit the calibration interface.

Note: Under normal conditions the self-calibration procedure will take

approximately 20 seconds. If it does not complete within this period of time or it stops on one of the calibration settings, then there may be a problem with the instrument.

Interface Test

The SDS2000X series oscilloscope is designed with four standard interfaces: USB Host, USB Device, LAN and Pass/Fail. Connecting to other instruments via these interfaces enables the oscilloscope to achieve additional capabilities. In order to ensure the oscilloscope is operating properly it is recommended that the user first test the interfaces.

USB Host Test

To test whether the USB Host interface is operating correctly.

Tools:

- A U disk

Steps:

1. Insert a U disk (flash drive) into the USB Host interface on the front panel of the oscilloscope.
2. A message prompt “USB Flash Drive Plug In!”, appears on the screen, and an icon will be shown in the lower right corner of the screen which confirms the U disk has been successfully recognized.

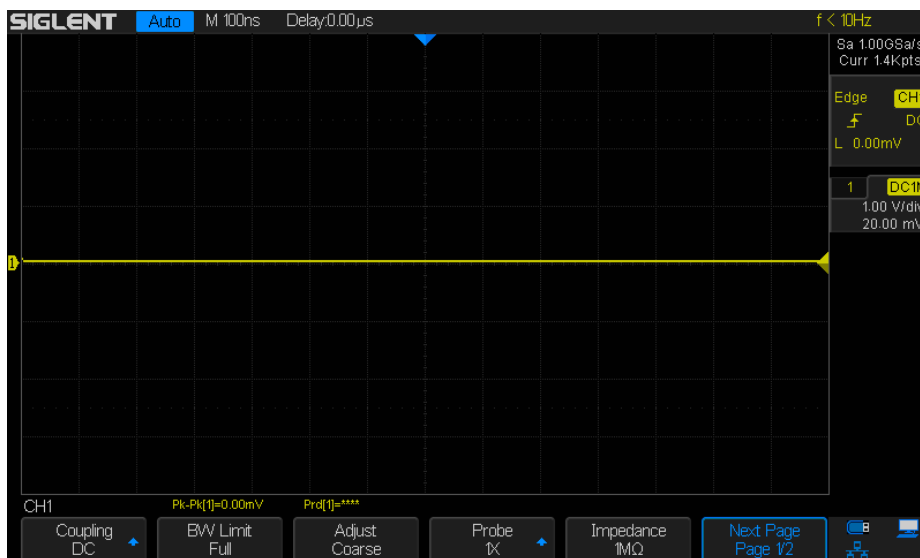


Figure 3 USB drive in interface

USB Device Test

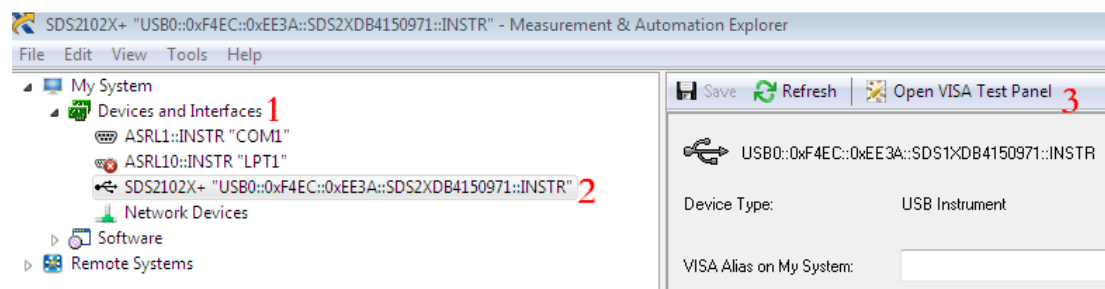
To test if the USB Device interface operating correctly.

Tools:

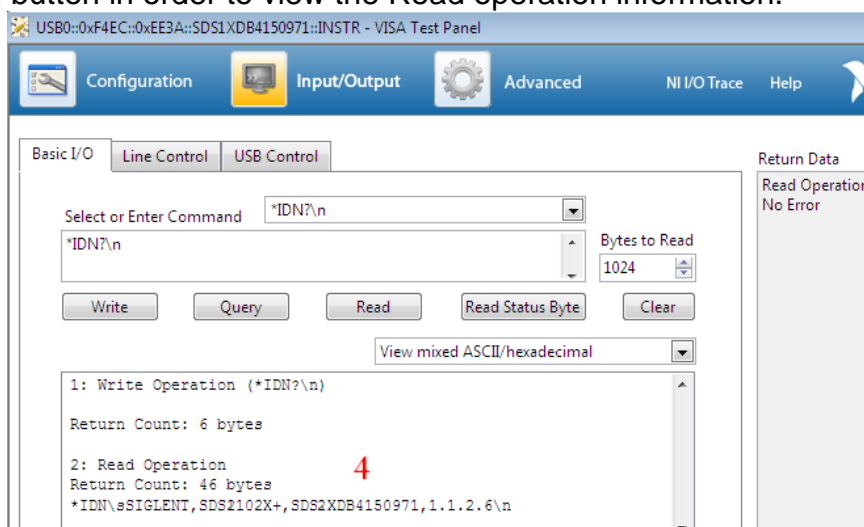
- A computer with USB interface
- A standard USB cable (Type AB)
- NI Max software

Steps:

1. Set up NI Max software in a computer and Install the driver step by step following the instructions.
2. Connect the oscilloscope to the computer using an USB cable.
3. Run NI Max software. Click “Device and Interface” at the upper left corner of the NI software interface and immediately the “USBTMC” device symbol is displayed.



4. Click “Open VISA Test Panel” option button, and then the following Interface will appear. Next, click the “Input/Output” option button and click the “Query” option button in order to view the Read operation information.



LAN Port Test

Use to test if the LAN interface operates correctly when connected with NI Visa software.

Tools:

- A computer with LAN interface
- A standard LAN cable
- NI Max software

Steps:

1. Set up NI Max software in a computer and install the driver using the following instructions.
2. Press **Utility** → **Page2/3** → **I/O** → **LAN**, input usable IP Address and Subnet Mask.

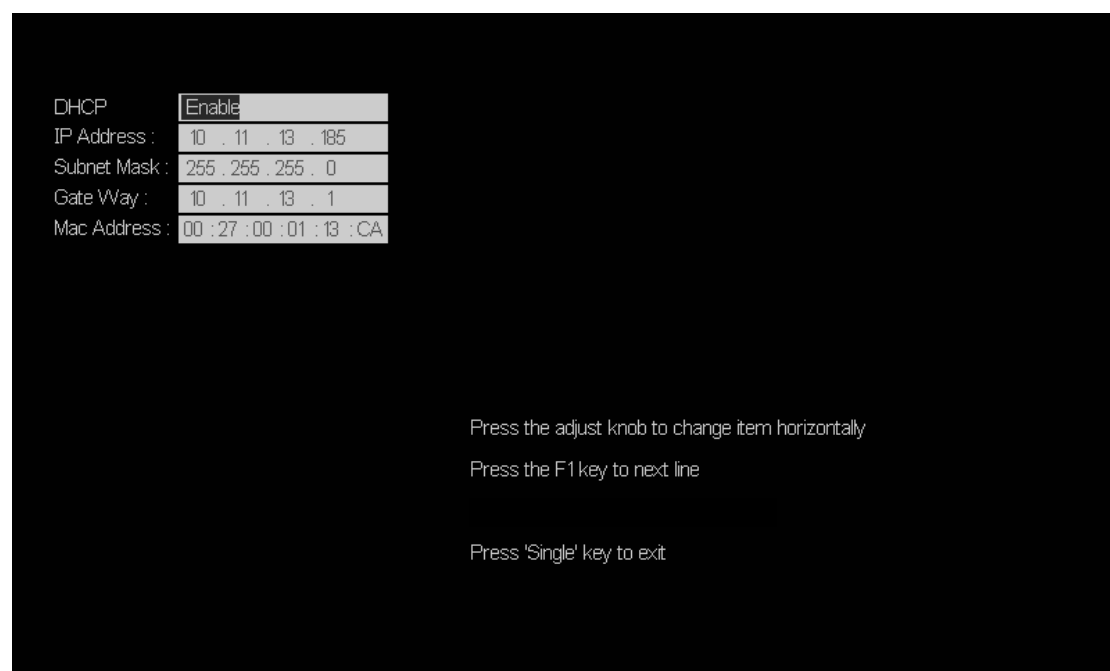


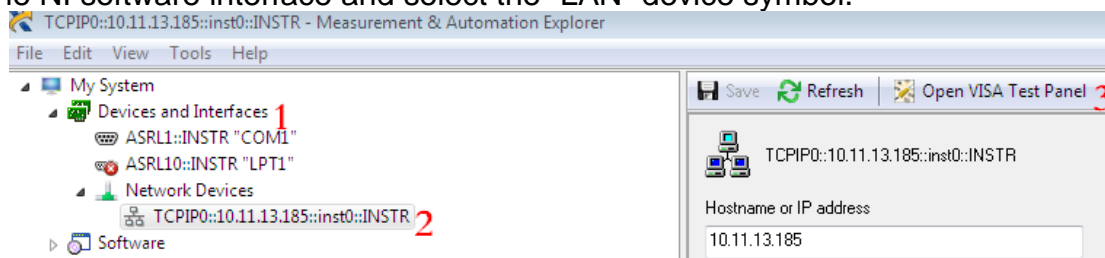
Figure 4 IP Setting interface

3. Connect the oscilloscope to the computer using a LAN cable via the LAN interface ports.

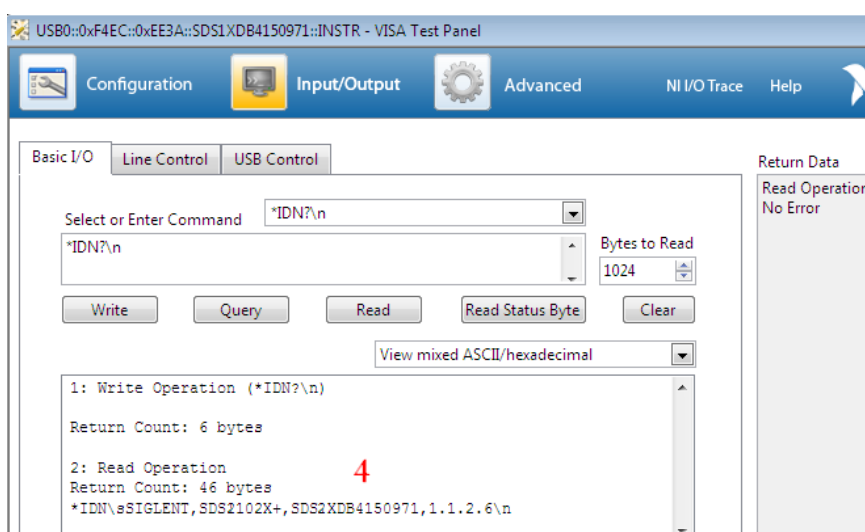


Figure 5 LAN interface

- Run NI Max software. Click “Device and Interface” at the upper left corner of the NI software interface and select the “LAN” device symbol.



- Click “Open VISA Test Panel” option button, which then displays the following interface (below). Then click the “Input/Output” option button and click the “Query” option button;. The Read operation information will be displayed.



Pass/Fail out Test

To test the Pass/Fail function and signal output by viewing on a second oscilloscope.

Tools:

- A second oscilloscope
- Two BNC cables

Steps:

1. Turn on the SDS2000X oscilloscope.
2. Enable Channel 1.
3. Press **Utility** → **Page2/3** → **Pass/Fail**, set the submenu items under Pass/Fail menu as below:

Table 3 Pass/Fail submenu items

Submenu	Setting
Enable Test	On
Source	CH1
Msg Display	On
Mask setting	
X Mask	0.32div
Y Mask	0.32div

Note: Remember to press “Create Mask” to complete Mask setting, after x mask setting and y mask setting.

After selecting the corresponding items as shown in the table above, the SDS2000X screen will appear as in Figure 6:

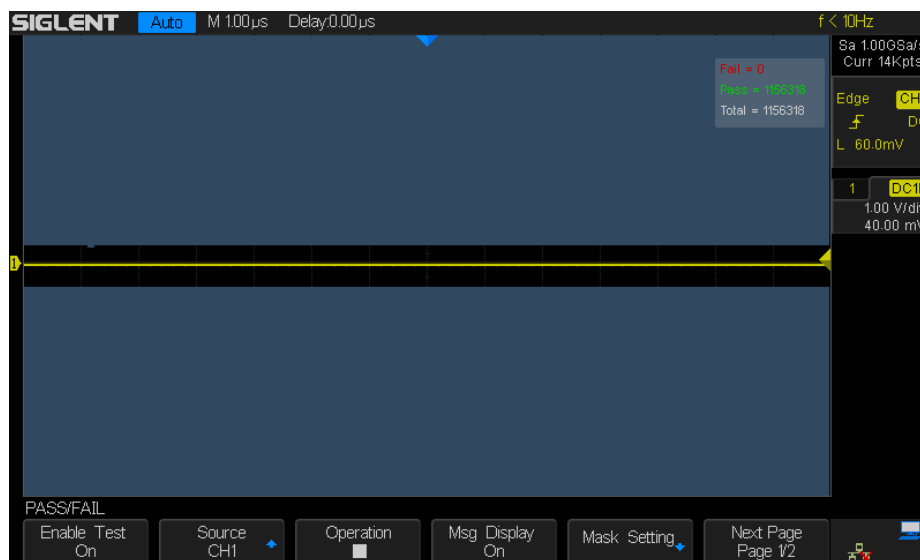


Figure 6 Pass/Fail Waveform

If the waveform is within the range that was set under Mask menu setting, the waveform displayed on the screen will Pass. If any part of the trace falls outside the Mask area then it will Fail.

4. Connect the Pass/Fail output signal (on the rear panel) to the input terminal of another oscilloscope.
5. Move the waveform on the screen up, down, or sideways so that any portion of it falls outside of the Pass/Fail mask. If the interface is operating normally then a pulse will appear on the second oscilloscope (Figure 7). Adjust the second oscilloscope's time base and voltage scale as needed. If there is no viewable pulse on the second oscilloscope then there may be a problem with this function.

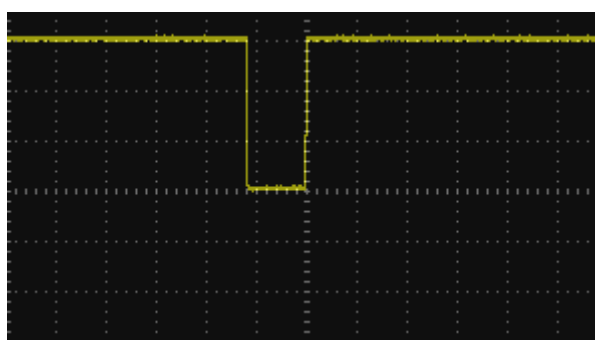


Figure 7 Pulse Waveform

Performance Test

This chapter explains testing the oscilloscope in order to verify performance specifications. For accurate test results, please let the test instruments and the oscilloscope warm up 30 minutes before testing.

Below is the required equipment for the test:

Table 4 Test equipment

Equipment	Description	Test item
Fluke 9500B + Active Heads	High Performance Oscilloscope Calibrator	DCG\Offset\ Ext Trigger delay\Clock accuracy\Trigger delay\ BW\BWL\trigger sensitivity\ Input impedance
Siglent SDM3055	Multimeter	AWG
Agilent U2004A	Power meter	AWG
GPIB Card and Cable	For communication between the computer and the 9500B	
USB Cable	For communication between the computer and the SDS2000X	
BNC Cables	BNC(m) to BNC(m), Approx.1m long	
BNC T Connectors	For signal distribution	DCG\Offset\Ext Trigger level
Computer		

The figures below shows the interconnections between the test equipment and PC to the oscilloscope under test (Table 4):

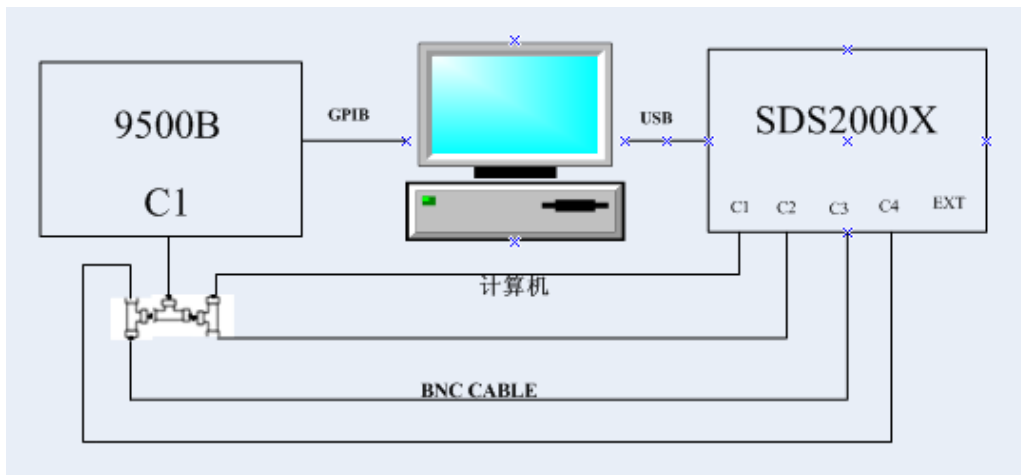


Figure 8 Connecting test instruments for DCG\Offset

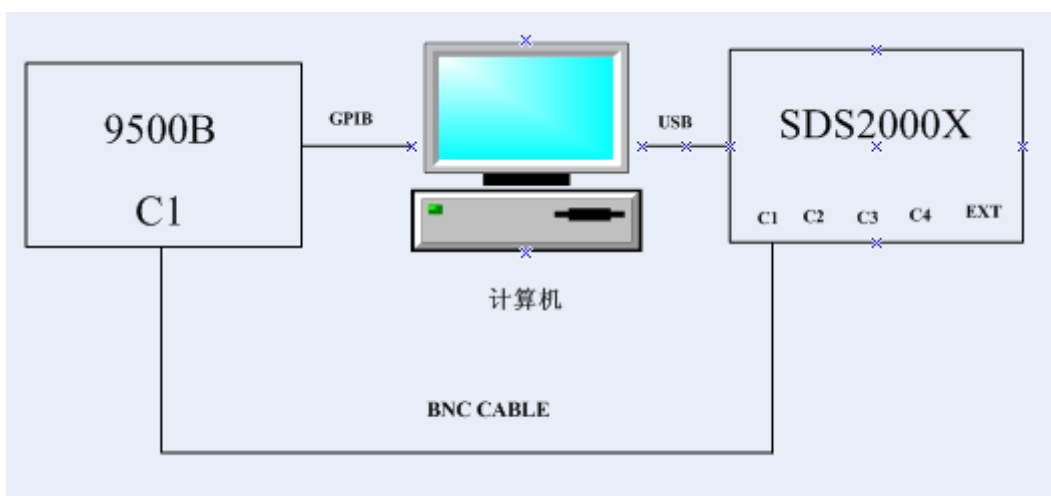


Figure 9 Connecting test instruments for Clock/Trigger Delay

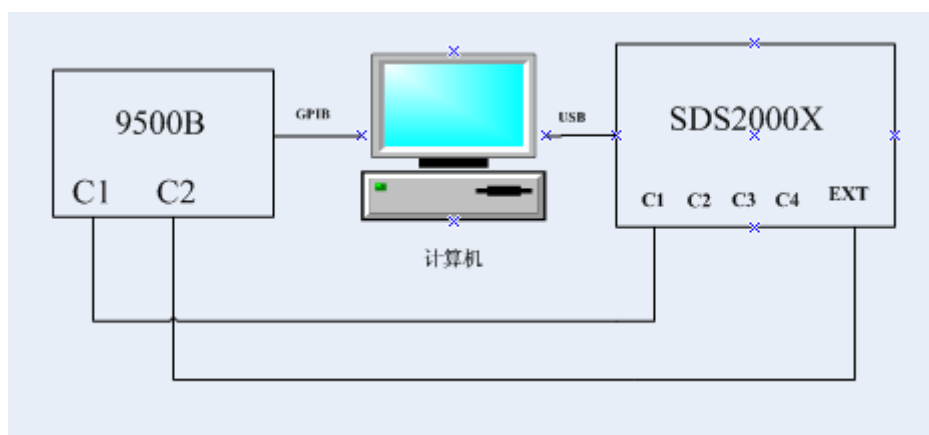


Figure 10 Connecting test instruments for Ext Trigger Delay

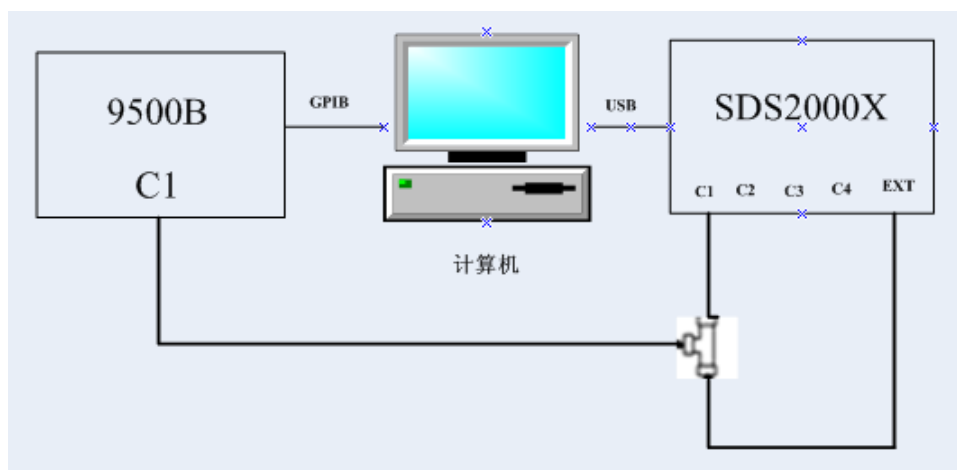


Figure 11 Connecting test instruments for Ext Trigger Level

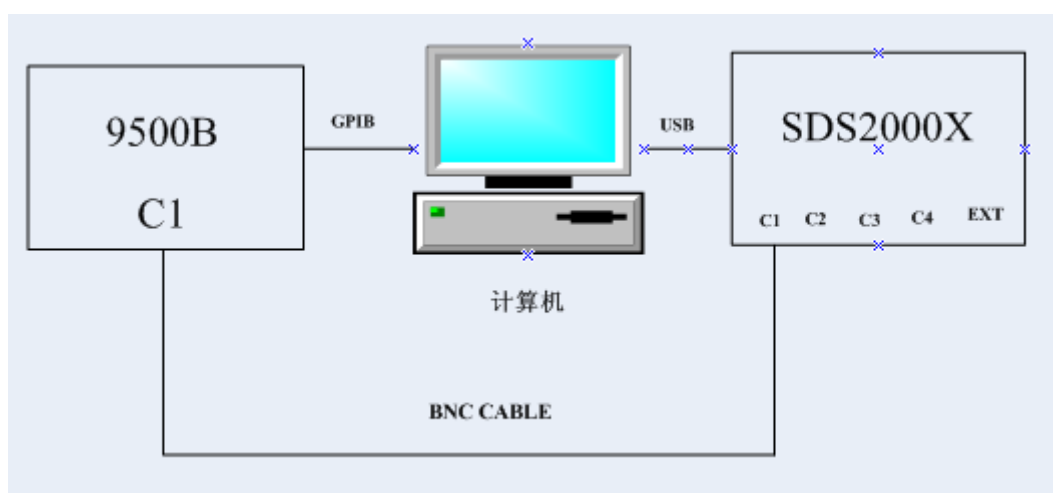


Figure 12 Connecting test instruments for BW\BWL\Trigger Sensitivity\Input impedance

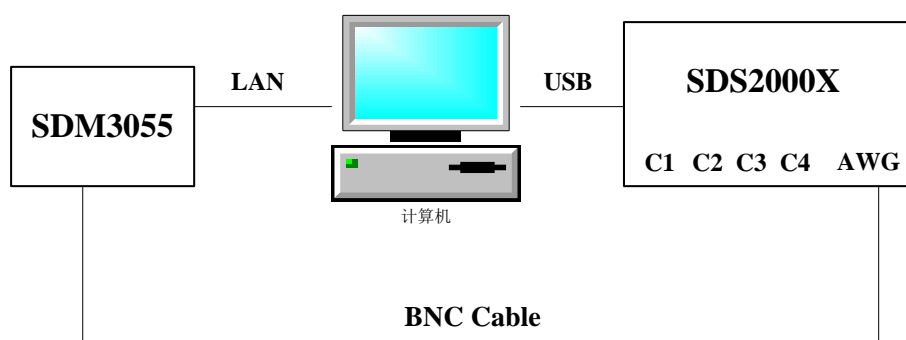


Figure 13 Connecting test instruments for AWG Offset Accuracy

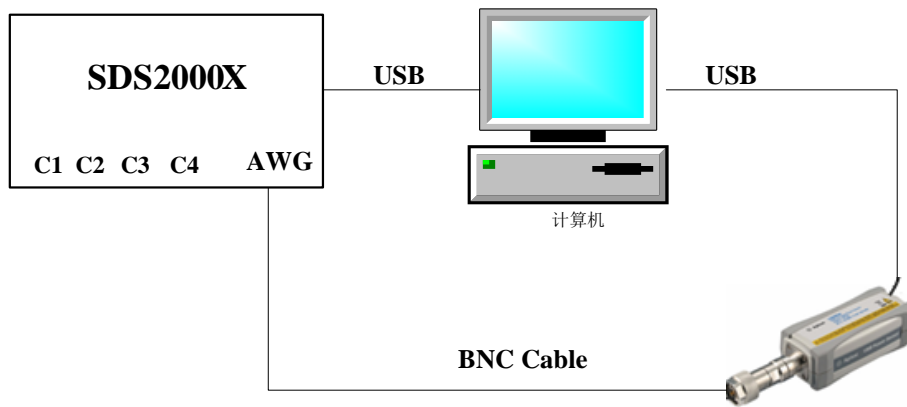


Figure 14 Connecting test instruments for AWG Frequency Response

Verify Test Results

To verify whether or not a test passes (i.e. whether the readings are within the appropriate limits), it is necessary to record the readings in the Performance Test located in the Test Record.

Self Calibration

The Self Calibration procedure is described in Chapter "Self Calibration". If the environmental temperature changes by more than 5°C, the Self Calibration operation must be performed in order to achieve the specifications.

To Verify DC Gain Accuracy

DC Gain Accuracy Slope = LINEST($V_{\text{error}1}$: $V_{\text{error}5}$, $V_{\text{Setting}1}$: $V_{\text{Setting}5}$)

Note: “ V_{Setting} ” represents DC voltage output level setting;
 “ V_{error} ” represents the difference between the output setting and the measurement.

This test verifies DC Gain Accuracy of all channels.

Steps:

1. Set the 9500B output to on.
2. Connect all channels of the oscilloscope to the 9500B as shown in Figure 8.
3. Set Volts/Div of the oscilloscope to 2 mV/div. Press the **Measure** button on the front panel of the oscilloscope to display Mean measurement.
4. Set DC voltage output level of the 9500B according to Table 5, and record mean value of the oscilloscope as V_{mean} .
5. Calculate V_{error} ($V_{\text{error}} = V_{\text{Setting}} - V_{\text{mean}}$), and set the next output level as step 4.
6. Make a linear regression with these 5 data points: $V_{\text{Setting}1} \sim V_{\text{Setting}5}$, $V_{\text{error}1} \sim V_{\text{error}5}$. Check if the slope falls within the range shown in Table 5.
7. Set the oscilloscope Volts/Div to the other settings in Table 5, and repeat steps 4 to 6.
8. Turn the 9500B output off.
9. Disconnect the connection to all the channels.

Table 5 DC Gain Accuracy

Volt/Div	DC voltage output levels	DC Gain Accuracy
10 V/div	30 V, 15V ,0, -15 V, -30 V	3%
5 V/div	15 V, 7.5 V, 0, -7.5 V, -15 V	3%
2 V/div	6 V, 3 V, 0, -3 V, -6 V	3%
1 V/div	3 V, 1.5 V, 0, -1.5 V, -3 V	3%
500 mV/div	1.5 V, 0.75 V, 0, -0.75 V, -1.5 V	3%
200 mV/div	600 mV, 300 mV, 0, -300 mV, -600 mV	3%
100 mV/div	300 mV, 150 mV, 0, -150 mV, -300 mV	3%
50 mV/div	150 mV, 75 mV, 0, -75 mV, -150 mV	3%
20 mV/div	60 mV, 30 mV, 0, -30 mV, -60 mV	3%
10 mV/div	30 mV, 150 mV, 0, -150 mV, -30 mV	3%

SIGLENT

5 mV/div	15 mV, 7.5 mV, 0, -7.5 mV-15 mV	3%
2 mV/div	6 mV, 3 mV, 0, -3 mV, -6 mV	4%

To Verify Offset Accuracy

Offset Accuracy Slope = LINEST(Offset_{error1}:Offset_{error5}, Offset₁:Offset₅)

Note: “Offset_{out}” represents DC voltage output level setting;
 “Offset_{error}” represents the difference between the output setting and the measurement.

This test verifies Offset Accuracy of all the channels.

Steps:

1. Set the 9500B output to on.
2. Connect all channels of the oscilloscope to 9500B as shown in Figure 8.
3. Set the Volts/Div of channel to 2 mV/div. Press **Measure** button on the front panel of the oscilloscope to display Mean measurement.
4. According to Table 6, set offset of the channel to -Offset, and set the 9500B output level to equal the offset, then record the mean value of the oscilloscope as V_{mean} .
5. Calculate Offset_{error} (Offset_{error}= V_{mean} - Offset), and adjust the 9500B to the output level as step 4.
6. Make a linear regression with these 5 data points: Offset_{error1}~Offset_{error5}, Offset₁~Offset₅. Check to verify that the slope is within the limits specified below.
7. Set the oscilloscope Volts/Div to the other settings in Table 6, and repeat the steps 4 to 6.
8. Turn the 9500B output off.
9. Disconnect the connection to all the channels.

Table 6 Offset Accuracy

Volt/Div	Offset	error
10 V/div	35 V,30 V,0,-3 0V,-35 V	1.5%
5 V/div	30 V,25 V,0,-25 V,-30 V	1.5%
2 V/div	20 V,10 V,0,-10 V,-20 V	1.5%
1 V/div	10 V,5 V,0,-5 V,-10 V	1.5%
500 mV/div	5 V,2.5 V,0,-2.5 V,-5 V	1.5%
200 mV/div	2 V,1 V,0,-1 V,-2 V	1.5%
100 mV/div	1 V,0.5 V,0,-0.5 V,-1 V	1.5%
50 mV/div	500 mV,250 mV,0,-250 mV,-500 mV	1.5%
20 mV/div	200 mV,100 mV,0,-100 mV,-200 mV	1.5%

SIGLENT

10 mV/div	100 mV, 50 mV,0,- 50 mV,-100 mV	1.5%
5 mV/div	50 mV,25 mV,0,-25 mV-50 mV	1.5%
2 mV/div	20 mV, 10 mV,0,-10 mV, -20 mV	1.5%

To Verify Time Base Accuracy

This test verifies the time base accuracy of the oscilloscope. In the test, the impedance of both the 9500B and the oscilloscope should be set to 50 Ω .

Time Base Accuracy: Frequency Error < 1.2 kHz

Steps:

1. Connect selected channel of the oscilloscope to the 9500B.
2. Set the oscilloscope Volts/Div to 100 mV/div.
3. Set the oscilloscope Sec/Div to 50 ms/div.
4. Set the Memory Depth to 28 Mpts, and the sample rate will be automatically set to 40 MSa/s.
5. Disable the ROLL mode if it is enabled.
6. Set waveform of the 9500B to sine, amplitude to 600 mV, and frequency to the value which is equal to the sample rate of the oscilloscope.
7. Press **Measure** button on the front panel of the oscilloscope to display Freq measurement.
8. Check if the Freq measurement is less than 1.2 kHz.
9. Disconnect the test connection.

To Verify Trigger Delay

This test checks the trigger delay of the analog channels. In this test, the impedance of both the 9500B and the oscilloscope should be set to 50 Ω .

Channel Trigger Delay Limit: Delay < 100 ps

Steps:

1. Connect selected channel of the oscilloscope to the 9500B.
2. Set frequency of the 9500B to 100 MHz, amplitude to 600 mV, and waveform to Sine.
3. Set the oscilloscope Volts/Div to 100 mV/div.
4. Set the oscilloscope Sec/Div to 1 ns/div.
5. Press **Measure** button on the front panel of the oscilloscope to display Time@Mid measurement.
6. Check if the result is in the limited range above.
7. Disconnect the test connection.
8. Check other channels in the same way as step 1 to step 7.

To Verify Ext Trigger Delay

This test checks the delay between ext trigger channel and analog channels. In the test, the impedance of both the 9500B and the oscilloscope should be set to 50 Ω .

CH-Ext Trigger Delay Limit: Delay < 1 ns

Steps:

1. Connect selected analog channel and ext trigger channel of the oscilloscope to the 9500B with active heads (CH1/CH2).
2. Press the 'Aux' key at the right of the 'OSCILLOSCOPE CALIBRATOR' panel of the 9500B and select the Zero Skew function.
3. Set frequency of the 9500B to 1 KHz, amplitude to 1 V.
4. Set the oscilloscope Volts/Div to 200 mV/div.
5. Set the oscilloscope Sec/Div to 2 ns/div.
6. Set the oscilloscope trigger source to EXT, the trigger slope to Rising, and the trigger level to 0.
7. Press **Measure** button on the front panel of the oscilloscope to display Delay measurement.
8. Check if the delay is within the limited range above (<1 ns).
9. Disconnect the test connection.
10. Check the other analog channel in the same way as step 1 to 9.

To Verify Ext Trigger Level

This test checks the trigger level accuracy of the ext trigger. In this test, the impedance of both the 9500B and the oscilloscope should be set to 50 Ω.

Table 7 EXT Trigger Level data

Trigger Channel	Volt/div	Trigger Level	Limited Range
EXT	150 mV	-450 mV	Trigger level±45 mV
		0	
		450 mV	
EXT/5	350 mV	-1.05 V	Trigger level±225 mV
		0	
		1.05 V	

Steps:

1. Connect channel 1 and ext trigger channel of the oscilloscope to the 9500B with a BNC T connector, as shown in Figure 11.
2. Set frequency of the 9500B to 2 kHz, amplitude to 1.2 V, and waveform to sine.
3. Set the oscilloscope Sec/Div to 100 us/div.
4. Set the oscilloscope Volts/Div to 150 mV/div, trigger source to EXT, and coupling mode to DC.
5. Set the trigger slope to Rising.
6. Set the trigger level according to Table 7
7. Press **Measure** button on the front panel of the oscilloscope to display Level@Trigger measurement.
8. Check if the result is in the limited range above.
9. Set the trigger slope to Falling, repeat step 6 to step 8.
10. Set amplitude of the 9500B to 2.6V, set trigger source of the oscilloscope to EXT/5, and the Volts/div to 350 mV.
11. Repeat step 5 to step 9.
12. Disconnect the test connection.

To Verify Noise Floor

This test checks the noise floor of the analog channels. In this test, do not connect any testing devices to the oscilloscope.

Table 8 Noise Floor Limited Range

Volt/Div	Limited Range	Volt/Div	Limited Range
500 uV	stdev<350 uV	100 mV	stdev<20 mV
1 mV	stdev<0.3 mV	200 mV	stdev<40 mV
2 mV	stdev<0.4 mV	500 mV	stdev<100 mV
5 mV	stdev<1 mV	1 V	stdev<200 mV
10 mV	stdev<2 mV	2 V	stdev<400 mV
20 mV	stdev<4 mV	5 V	stdev<1 V
50 mV	stdev<10 mV	10 V	stdev<2 V

Steps:

1. Set the oscilloscope Sec/Div to 1 ms/div.
2. Set the oscilloscope Volts/Div to 500 uV/div.
3. Press **Measure** button on the front panel of the oscilloscope to display Stdev measurement.
4. Check if the Stdev is in the limited range shown in Table 8.
5. Check the other analog channels in the same way as step 1 to 4.
6. Set the oscilloscope Volts/Div to the others in the table above, and repeat the steps from 3 to 5.

To Verify Bandwidth

This test checks the bandwidth of all analog channels.

The bandwidth should be verified at 2 V/div、200 mV/div and 100 mV/div.

Steps:

1. Connect channel 1 of the oscilloscope to the 9500B via the active head, as shown in Figure 12.
2. Set the oscilloscope Volts/Div to 2 V/div, the Sec/Div to 50 ms/div, the impedance of the channel to 50 Ω.
3. Press the **Measure** button on the front panel of the oscilloscope to display Peak-Peak measurement.
4. Set waveform of the 9500B to sine, amplitude to 5.5 V, and impedance to 50 Ω.
5. Set frequency of the 9500B to the frequency in Table 9. When testing at 200 mV/div or 100 mV/div, set start frequency at 100 kHz. Set frequency start frequency at 1 MHz when testing at 2 V/div.

Table 9 Frequency points in the test

Scope Model	Frequency Point (Hz)
SDS2104X /SDS2102X	100K,500K,1M,5M,10M,30M,50M,70M,100M,110M,130M,150M
SDS2204X /SDS2202X	100K,500K,1M,5M,10M,50M,100M,130M,150M,180M,200M,230M,250M
SDS2304X /SDS2302X	100K,500K,1M,5M,10M,50M,100M,120M,140M,160M,180M,200M,220M,240M,260M,280M,300M,340M,380M,400M

6. Every time the frequency is changed, it is recommended to adjust the Sec/Div to a proper value in order to display a complete waveform.
7. Record the Peak-Peak measurement of the waveform.
8. Set the oscilloscope Volts/Div to the setting choices, and repeat the steps from 2 to 7. Set amplitude of the 9500B to 600 mV when testing at 100 mV/div, and set to 1.2 V when testing at 200 mV/div.
9. Check other channels in the same way as steps 1 to 8.
10. Disconnect the test connection.

After the test, calculate the dB value at every frequent point. Check if the value

is in limited range in Table 10.

Table 10 Limited Range

Scope Model	Frequency Point (Hz)	Range
SDS2104X/ SDS2102X	≤10M	(-1,1) dB
	≤50M	(-2,2) dB
	>50M	(-3,2) dB
SDS2204X/ SDS2202X	≤20M	(-1,1) dB
	≤100M	(-2,2) dB
	>100M	(-3,2) dB
SDS2304X/ SDS2302X	≤30M	(-1,1) dB
	≤150M	(-2,2) dB
	>150M	(-3,2) dB

To Verify Bandwidth Limit

This test checks the bandwidth limit of all the analog channels. The test is similar to the bandwidth test except that the bandwidth limit is turned on.

Test the bandwidth at 2 V/div、 200 mV/div and 100 mV/div

Steps:

1. Connect channel 1 of the oscilloscope to the 9500B via the active head, as shown in Figure 12.
2. Set the oscilloscope Volts/Div to 2 V/div, the Sec/Div to 50 ms/div, the impedance of the channel to 50 Ω, and set BW Limit button to 20 MHz.
3. Press the **Measure** button on the front panel of the oscilloscope to display Peak-Peak measurement.
4. Set amplitude of the 9500B to 5.5 V.
5. Set frequency of the 9500B to the frequency in Table 11. When testing at 200 mV/div or 100 mV/div set the start frequency to 100 kHz. When testing at 2 V/div set start frequency to 1 MHz.

Table 11 Frequency points in the test

Frequency Point (Hz)
100K,500K,1M,5M,10M,12M,20M,28M

6. Every time the frequency is changed, it is recommended to adjust the Sec/Div to a proper value thus to display a complete waveform.
7. Record the Peak-Peak measurement value of the waveform.
8. Set the oscilloscope Volts/Div to the other settings and repeat the steps from 2 to 7. Set amplitude of the 9500B to 600 mV when testing at 100 mV/div, and set to 1.2 V when at 200 mV/div.
9. Check the other channels in the same way as in steps1 to 8.
10. Disconnect the test connection.

After the test, calculate the dB value at every frequency point. Check if the value falls within the range in Table 12.

Table 12 Limited Range

Frequency Point(Hz)	Range
≤19M	(-2,2)
>19M	(-6,2)

To Verify Trigger Sensitivity

This test checks trigger sensitivity at the frequency of 10 MHz and also at the bandwidth frequency.

Table 13 Trigger sensitivity data

Volts/Div	Frequency	Trigger Range
100 mV/div	10 MHz	9.9~10.1 MHz
100 mV/div	bandwidth	bandwidth \pm 1%

Steps:

1. Connect the selected channel of the oscilloscope to the 9500B, as shown in Figure 12.
2. Set the oscilloscope Volts/Div to 100 mV/div, Sec/Div to 50 ns/div, coupling mode to AC, and impedance to 50 Ω .
3. Set amplitude of the 9500B to 100 mV, frequency to 10 MHz.
4. Set trigger slope of the oscilloscope to Positive.
5. Press Trigger LEVEL knob to set the level to the center of the waveform.
6. Adjust the trigger level within the waveform range to achieve a stable trigger.
7. Record the (hardware-measured) frequency which is on the top right of the screen, and check that it is in the specified trigger range listed in Table 13.
8. Set the oscilloscope trigger slope to Negative, repeat steps 5 to 8.
9. Set frequency of the 9500B to the bandwidth frequency of the oscilloscope. Set the oscilloscope Sec/Div to 5 ns/div if testing SDS2104X/SDS2012X, set Sec/Div to 2 ns/div and if testing SDS2204X/SDS2202X or SDS2304X/SDS2302X. Then repeat steps 4 to 8.
10. Check the other channels in the same way as step 1 to 9.
11. Disconnect the test connection.

The steps above are for testing the trigger level when using internal trigger using the analog input channels. The following steps are used to test the EXT trigger sensitivity.

Steps:

1. Connect the ext trigger channel of the oscilloscope to the 9500B.
2. Set amplitude of the 9500B to 200 mV, frequency to 10 MHz.
3. Set trigger source of the oscilloscope to EXT, trigger slope to Positive.
4. Press Trigger Level knob to set the level to the center of the waveform.

SIGLENT

5. Adjust the trigger level within the range of (-100 mV - 100 mV) in order to achieve a stable waveform and then record the (hardware-measured) frequency, located at the top right of area of the screen.
6. Check if the frequency is within the specified trigger range listed in Table 13.
7. Set trigger slope to Negative, repeat steps 4 to 6.
8. Set frequency of the 9500B to the oscilloscope's bandwidth frequency, amplitude to 300 mV. Repeat steps 3 to 7. In step 6, the range changes to (-150 mV - 150 mV)
9. Set frequency of the 9500B to 10 MHz, amplitude to 1 V.
10. Set the trigger source of the oscilloscope to EXT/5, trigger slope to Positive.
11. Press Trigger Level knob to set the level to the center of the waveform.
12. Adjust the trigger level within the range of (-500mV - 500mV) to achieve a stable waveform and then record the hardware-measured value which is on the top right of screen.
13. Check if the frequency is within the specified range listed in Table 13.
14. Set the trigger slope to Negative, repeat steps 11 to 13.
15. Set the frequency of the 9500B to the oscilloscope's bandwidth frequency, amplitude to 1.5 V. Repeat steps 11 to 14. In step 6, the range changes to (-750 mV, - 750 mV)
16. Disconnect the test connection.

To Verify Input Impedance

This test checks the input impedance of all analog channels and ext trigger channel with different coupling modes and vertical scales (100 mV/div, 200 mV/div and 2 V/div).

Table 14 Input Impedance data

Channel	Coupling and impedance type	Impedance Range	
CH	AC/1 M Ω	0.1V/div	1176000~1224000 Ω
		0.2V/div, 2V/div	980000~1020000 Ω
	DC/1 M Ω	980000~1020000 Ω	
	AC/50 Ω	49~51 Ω	
	DC/50 Ω	49~51 Ω	
Ext	50 Ω	49~51 Ω	

Steps:

1. Connect the selected channel of the oscilloscope to the 9500B, as shown in Figure 12.
2. Set the oscilloscope Volts/Div to 100 mV/div, coupling mode of the channel to AC, and impedance to 1 M Ω .
3. Press the 'Aux' key at the right of the 'OSCILLOSCOPE CALIBRATOR' panel of the 9500B and select the Load Resistance Measurement Function. Record the reading displays on the screen of the 9500B.
4. Set impedance of the channel to 50 Ω , and then record the reading displays on the screen of the 9500B.
5. Set coupling mode of the channel to DC, and impedance of the channel to 1 M Ω . Record the reading displays on the screen of the 9500B.
6. Set impedance of the channel to 50 Ω , and record the reading displays on the screen of the 9500B.
7. Check if the impedance is within the specified range in Table 14.
8. Test at 2 V/div and 200 mV/div, using the same procedure as in steps 2 to 7.
9. Check the other analog channels in the same way as steps 1 to 8.
10. Disconnect the test connection

When checking the EXT trigger channel, set impedance of the ext trigger channel to 50 Ω . Then record the reading displays on the screen of the 9500B, and check to verify it is within the specified range in Table 14.

To Verify AWG

This test checks the Wave Generator option of oscilloscope, using a Siglent SDM3055 multimeter and an Agilent U2004A power meter.

This test includes three items: Offset Accuracy, Amplitude Accuracy, and Frequency Response.

Table 15 Offset Accuracy

DC Volt	Limit Range	DC Volt	Limit Range
3 V	2.9736~3.0264 V	-3 V	-3.0264~-2.9736 V
1 V	0.9896~1.0104 V	-1 V	-1.0104~-0.9896 V
0.1 V	0.0968~0.1032 V	-0.1 V	-0.1032~-0.0968 V
0.01 V	0.00752~0.01248 V	-0.01 V	-0.01248~-0.00752 V
0 V	-0.0024~0.0024 V		

Table 16 Amplitude Accuracy

Amplitude	Limit Power Range
80 mV	26.7~29.9 mV
400 mV	136.4~146.4 mV
1 V	342.2~365 mV
4 V	1.371~1.4574 V

Table 17 Frequency Response

Amplitude	Frequency (Hz)	Power Range
2 V	10K,100K,1M, 2M, 3M, ...15M,16M, ...24M,25M	3.6794~4.2794 dBm
5 V	10K,100K,1M, 2M, 3M, ...15M,16M, ...24M, 25M	11.64~12.24 dBm

Steps:

1. Connect the AWG channel of the oscilloscope to the Multimeter, as shown in Figure 13.
2. Press **Wave Gen** button on the front panel of the oscilloscope to enable the AWG.
3. Set Output Load of the AWG to High-Z, and Wave Type to DC.
4. According to Table 15, set the DC Volt, then record the reading which displays on screen of the SDM3055. Check if it is within the specified range

in Table 15.

5. Set Wave Type to Sine, frequency to 10 kHz, and offset to 0.
6. Referring to Table 16, set amplitude of Sine, then record the reading which displays on the screen of the SDM3055. Check if it is within the specified range in Table 16.
7. Connect the AWG channel to the Agilent U2004A.
8. Set Wave Type to sine, frequency to 10 kHz, offset to 0, and amplitude to 2 V.
9. Change the frequency, referring to Table 17, then record the reading on the U2004A to make certain it is within the specified range in Table 17.
10. Set amplitude of the waveform to 5 V, repeat step 9.
11. Disconnect the test connection

Adjusting Procedures

This chapter describes how to adjust the SDS2000X series oscilloscopes for optimum performance using a Fluke 9500B calibrator. Only qualified personnel should perform this procedure.

Warming Up

Before performing the adjustment procedures the oscilloscope and other test instruments must warm up for at least 30 minutes in an ambient temperature between 20 °C and 30 °C. Adjustments performed prior to warm-up or outside this temperature range may result in poor performance.

Self Calibration

The Self-Cal performs a routine which uses internally generated signals to optimize circuits that affect channel sensitivity, offset, and trigger parameters, as well as optimizing the signal path in the oscilloscope. Let the oscilloscope warm up before performing this procedure.

Required Equipment

PC: Windows XP or Windows 7 operating system, USB interface, NI-VISA.
Calibrating Software: Python 2.7, PyVisa, PyQt4, PyWin32, Adjustment scripts
(**contact SIGLENT for the scripts**)

Test Instrument:

- Fluke 9500B
- Siglent SDM3055
- Agilent U2004A.
- One USB cable (Type AB)
- One GPIB cable
- One network cable
- Five 10-inch BNC cables
- One BNC T connector (3 females terminals)
- Two BNC T connectors (1 male + 2 females terminals)

Software Installation

1. Install the NI-488.2 driver, select custom installation to install NI-VISA.
2. Install the Python 2.7, PyVisa, PyQt4, PyWin32.

Adjusting Steps

1. Connect the Fluke 9500B with the PC using GPIB interface.
2. Connect the oscilloscope with the PC using an USB cable.
3. Connect the SDM3055 with the PC using a network cable.
4. Connect the Agilent U2004A with the PC using an USB cable.

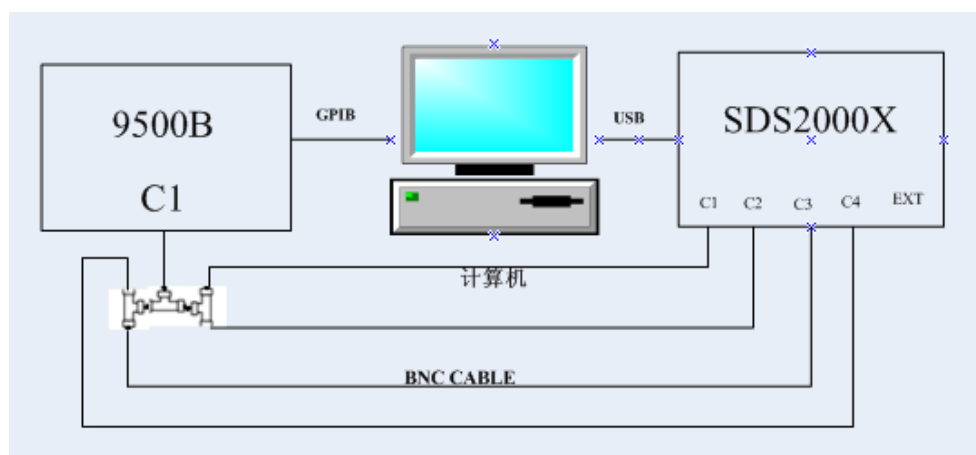


Figure 15 DAC adjusting environment

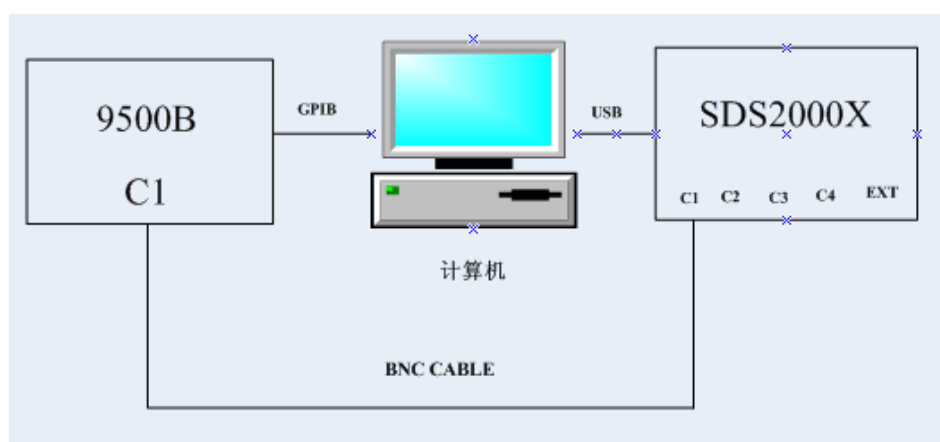


Figure 16 Clock Accuracy adjustment setup

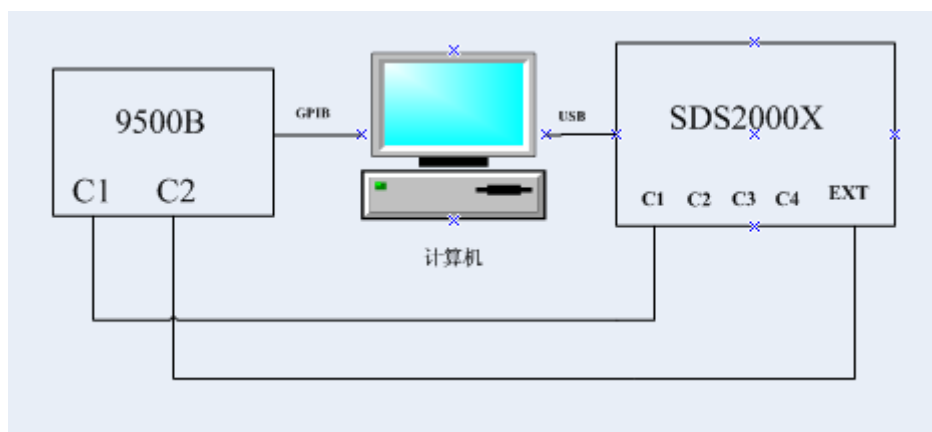


Figure 17 EXT Trigger Delay adjustment setup

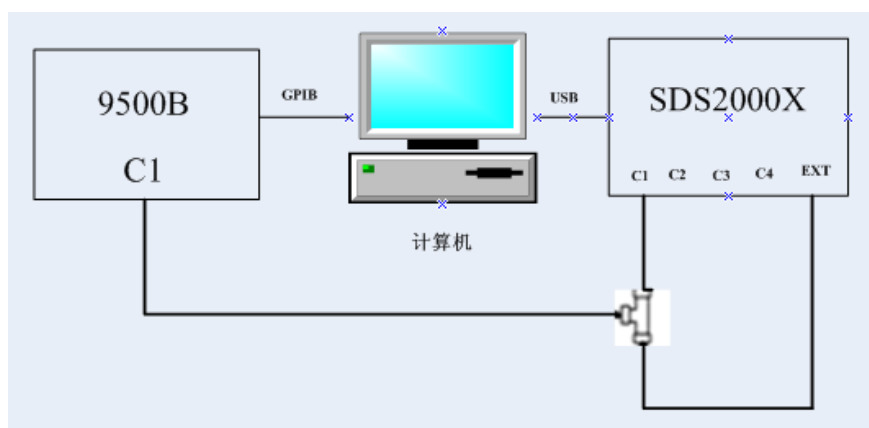


Figure 18 EXT Trigger Level adjustment setup

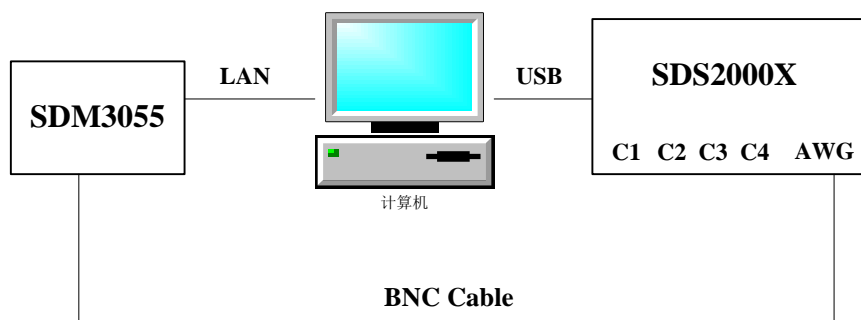


Figure 19 AWG adjustment setup

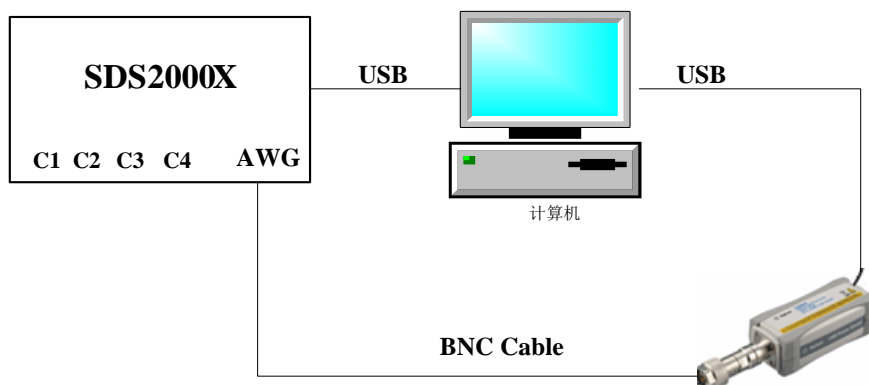


Figure 20 AWG adjustment setup

5. The details of the device IP address which are used in the setup are in the script titled *devicecon.py* in the path of SDS2000X\Lib.
6. Turn on the oscilloscope and allow it warm-up for about 30 minutes..
7. Connect the oscilloscope and the test instruments as shown in the figures above using the BNC T connectors and BNC cables.
8. Open the corresponding python script.
9. Click the 'CAL' button to perform the adjustment procedures.
10. When the DAC adjustment has completed, disconnect all analog inputs from the oscilloscope. Press the button UTILITY and then select Do Self Cal option to start the Self Calibration.
11. Perform the next step according to the message box which pops up during the adjustment process.
12. When all of these steps have been completed, disconnect all devices and close the python script.

Note: The adjustment procedures include routines for the following:

DAC, Self Calibration, Clock Accuracy, Ext trigger delay, Ext trigger level, AWG.

Assembly Procedures

This chapter describes how to remove the major modules from the SDS2000X series oscilloscopes. To install the removed modules or replace new modules, please follow the corresponding operating steps in reverse order.

This chapter includes the following topics:

- **Security Considerations** which describes security information needed to consider while operating.
- **List of Modules** in which the modules to remove are listed.
- **Required Tools** which describes the tools needed to perform the procedures.
- **Disassembly Procedures** which describes in detail how to remove and install the modules.

Security Considerations

Only qualified personnel should perform the disassembly procedures. Whenever possible, disconnect the power before you begin to remove or replace the modules. Otherwise, possible personal injuries or damages to the components may occur.

Avoid Electrical Shock Hazardous voltages exist on the LCD module and power supply module. To avoid electrical shock, first disconnect the power cord from the oscilloscope and then wait at least three minutes for the capacitors in the oscilloscope to discharge before you begin disassembly.

Preventing ESD Electrostatic discharge (ESD) can damage electronic components. When doing any of the procedures in this chapter, use proper ESD precautions. As a minimum, place the oscilloscope on a properly grounded ESD mat and wear a properly grounded ESD strap.

List of Modules

The following removable modules are listed in the order of performing disassembly procedures.

Table 18 List of modules

Number of Module	Module
1	Front-Panel Knobs
2	Rear Panel
3	Top Metal Cover
4	Rear Metal Cover
5	Power Supply Module
6	Metal Shelf and Interface Module
7	Main Board
8	Fan Module
9	Keypad Module
10	Display Module

Required Tools

Use these tools to remove or replace the modules in the oscilloscope:

- Multifunction screwdriver
- Antistatic gloves
- Custom screw hexagonal nut tool or long nose pliers

Disassembly Procedures

This section describes in detail how to remove and install the modules listed above in the oscilloscope. Complete disassembly will be best achieved using the following steps in order.

Removing the Front-Panel Knobs

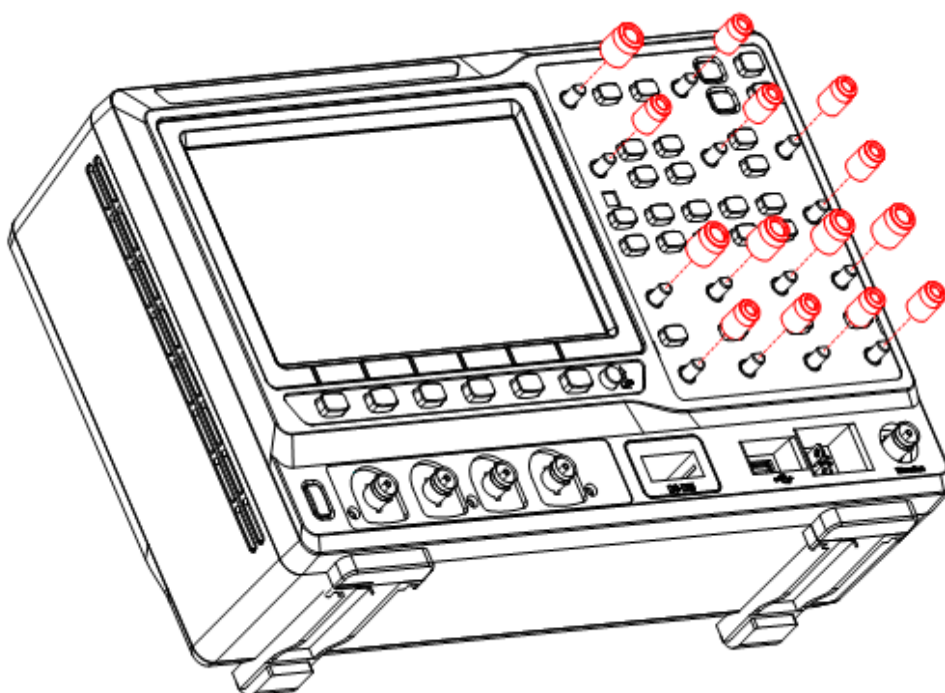


Figure 21 Removing the Front -Panel Knobs

Removing steps:

Remove each front-panel knob by firmly grasping the knob (with pliers protected by a soft cloth to prevent scratches, if necessary) and pulling it away from the front panel.

To install the Front -Panel Knobs, please perform these steps in reverse order.

Removing the Rear Panel

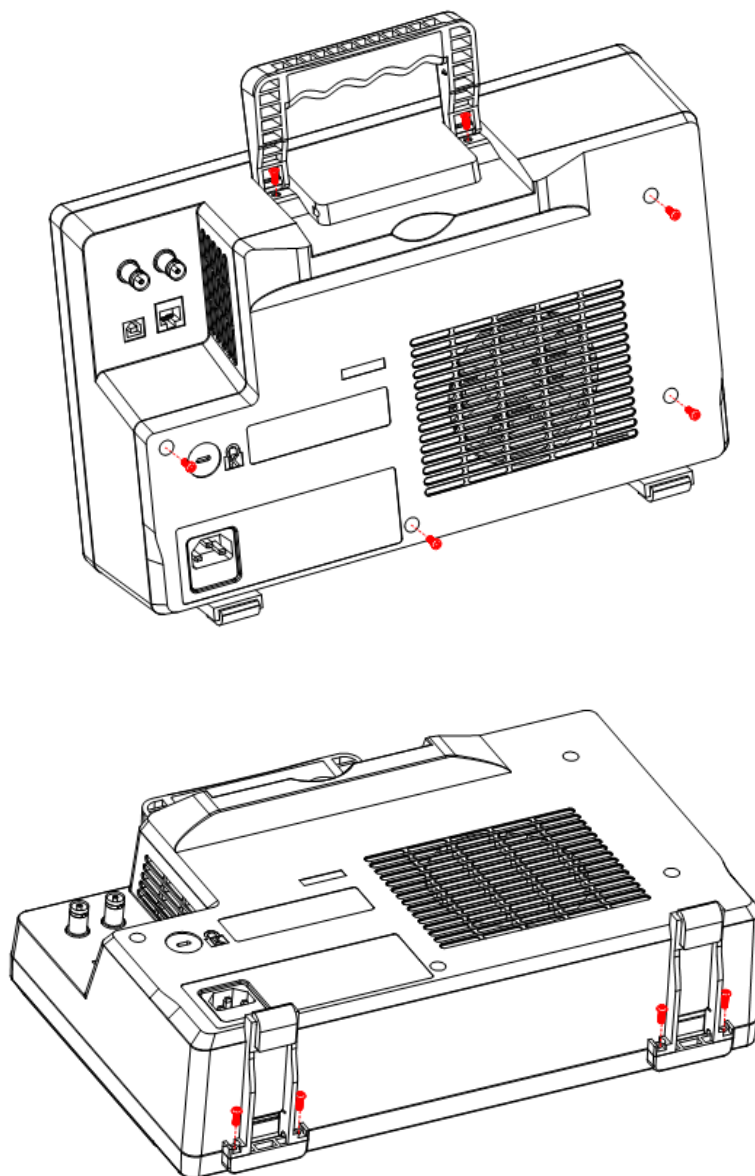


Figure 22 Removing the rear panel

Removing steps:

1. Place the oscilloscope face down on a soft surface such as an anti-static mat.
2. Remove the six screws located on the rear panel. In this same position, remove the four screws located on the tilt-legs..
3. Lift the rear panel up and off carefully.

SIGLENT

To install the rear panel, please follow these same steps in reverse order.

Removing the Rear Metal Cover

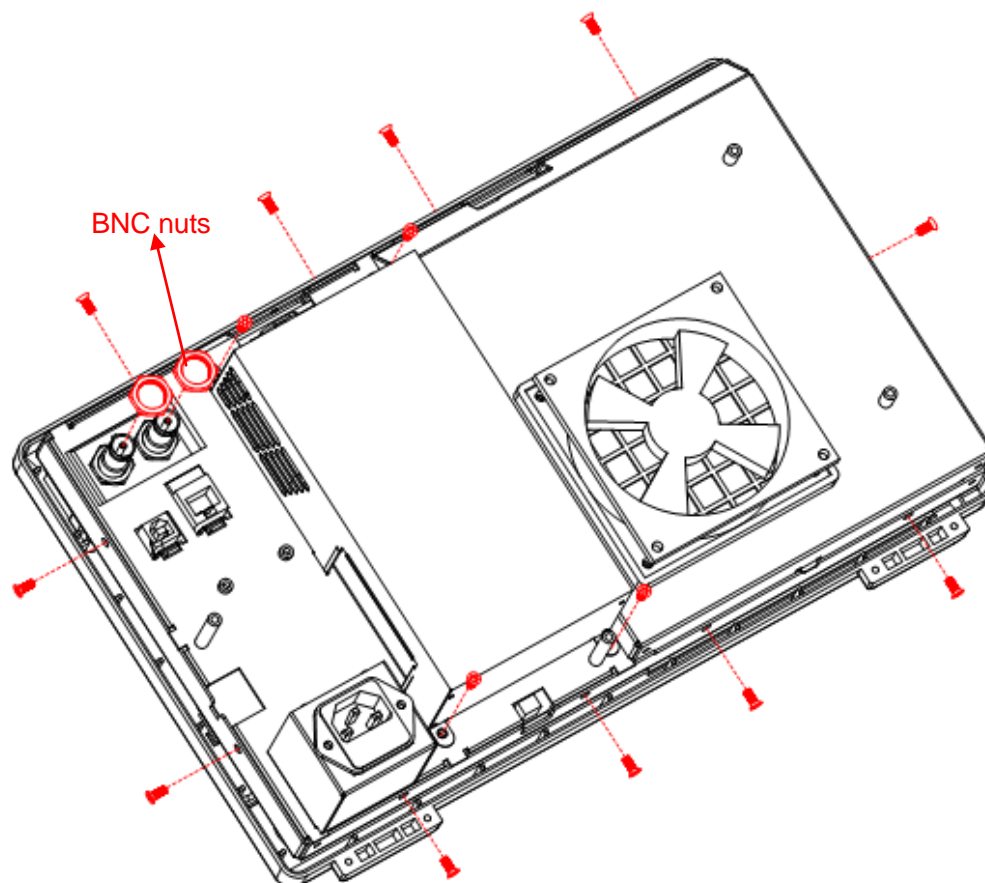


Figure 23 Removing the rear metal cover

Removing steps:

1. Place the oscilloscope face down on a soft surface such as an anti-static mat.
2. Remove the fifteen screws located on the rear metal cover.
3. Remove the two nuts from the Back BNC terminal.
4. Disconnect the power mains cable connected to the main board module from the power supply module.
5. The edge of the rear metal cover is sharp, please lift the rear metal cover up and off carefully to avoid personal injury.

To install the rear metal cover, please perform these steps in reverse order.

Removing the Front Panel

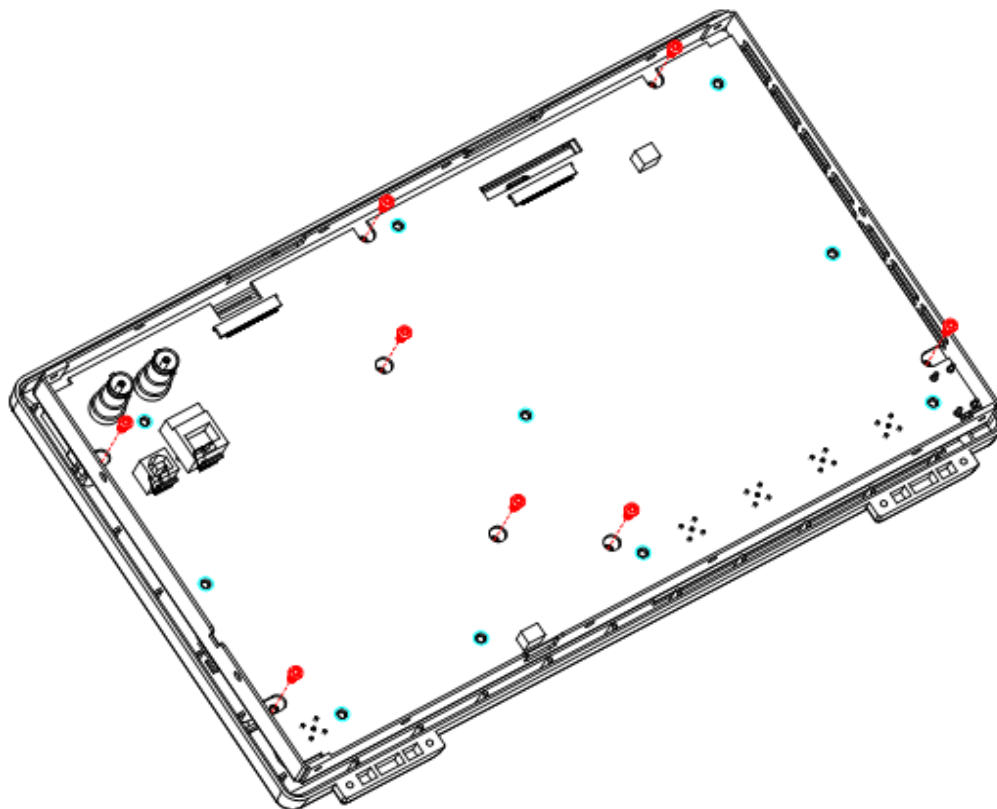


Figure 24 Removing the front panel

Removing steps:

1. Place the oscilloscope back-side down on a soft surface such as an anti-static mat.
2. Remove the eight screws located on the metal cover assembly.

To install the front panel, please perform these steps in reverse order.

Removing the LCD, Channel Board and Keyboard

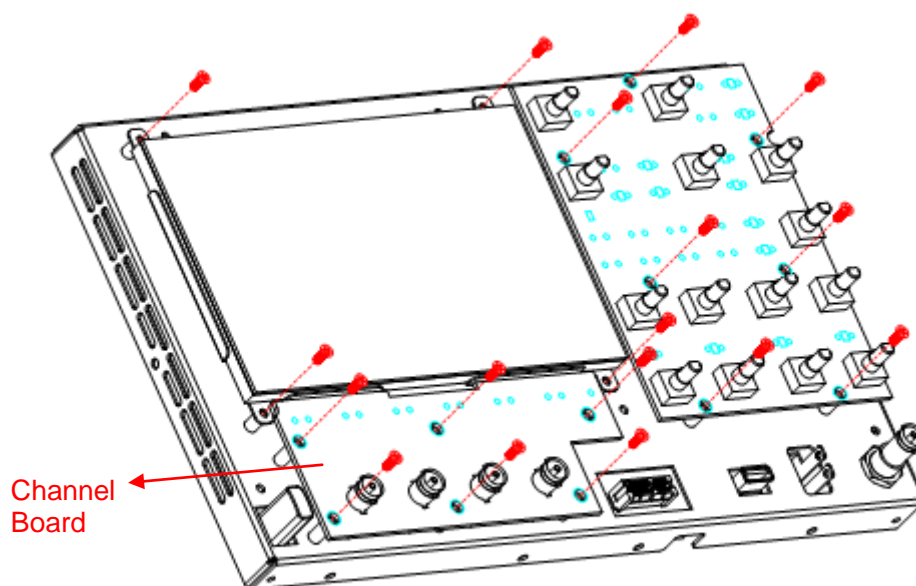


Figure 25 Removing the LCD, Channel board and keyboard

Removing steps:

1. Remove the silicone keypad.
2. Remove the four screws located on the edge of the display module.
3. Remove the six screws located on the channel board.
4. Remove the seven screws located on the keyboard.
5. Disconnect the cable that connects the keyboard and the channel board.
6. Separate the modules carefully.

Removing the Main Board

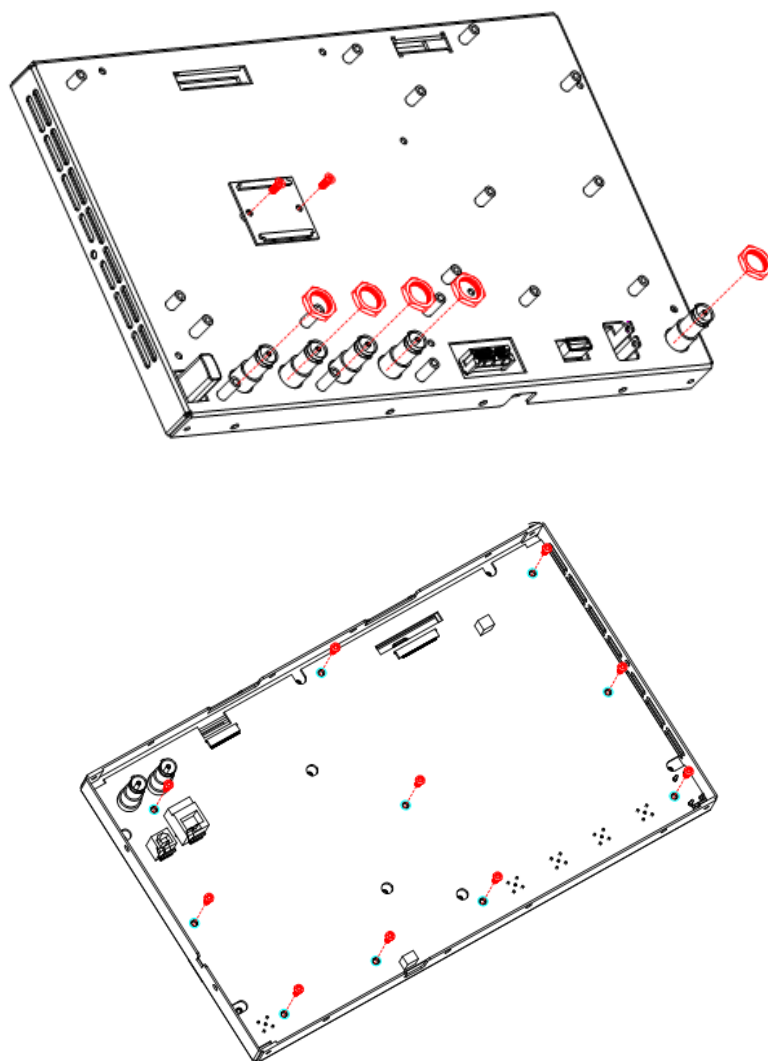


Figure 26 Removing the main board

Removing steps:

1. After removing the LCD module, disconnect the cable which connects to the plug board on the front metal assembly piece.
2. Remove the five nuts located on the channel BNC terminals.
3. Remove the ten screws located on the main board.
4. Separate the main board from the metal assembly and then lift it up and off carefully to avoid personal injury from the sharp edge of the metal

assembly.

To install the main board, please perform these steps in reverse order.

Troubleshooting Hardware Failures

This section provides information and procedures to deal with general hardware failures that might occur operating the oscilloscope. When troubleshooting these failures, it is important to take into consideration the following notices:

1. Please disconnect the power if finding a measured voltage value is different than the standard voltage value.
2. Before disconnecting the cables connected to main board or display module, please turn off the oscilloscope and disconnect the power cord.
3. While performing any internal testing of the oscilloscope, please take precautions to avoid damaging internal components or modules resulting from electrostatic discharge (ESD).

ESD Precautions

While performing any internal testing of the oscilloscope, please refer to the following precautions to avoid damage to the internal modules or components resulting from ESD.

- Hold circuit boards by the edges whenever possible.
- Reduce handling of static-sensitive modules as much as possible.
- Wear a grounded antistatic wrist strap to drain the static charge from your body while touching these modules.
- Operate static-sensitive modules only in static-free areas. Avoid handling modules in areas that contain anything capable of generating or holding a static charge.

Required Equipment

The equipment listed in the table are required to troubleshoot the oscilloscope.

Table 19 Required Equipment

Equipment	Critical Specifications	Example
Digital Multimeter	Accuracy $\pm 0.05\%$ 1 mV resolution	Agilent 34401A

Oscilloscope	300 MHz BW 1 MΩ/50 MΩ impedance
--------------	------------------------------------

Main Board Drawing

Please refer to the following drawing to quickly locate test points on the main board.

Test point beginning with a 'U' refers to ICs.

Test point beginning with a 'CL' refers to electronic capacity.

Test point beginning with a 'T' refers to pads.

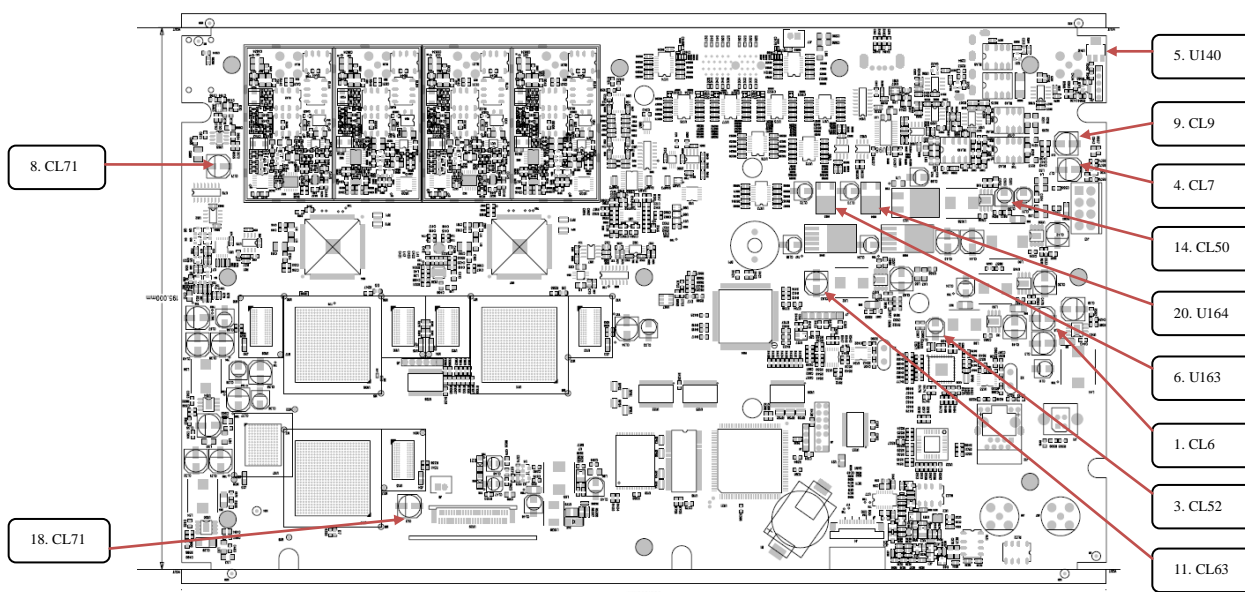
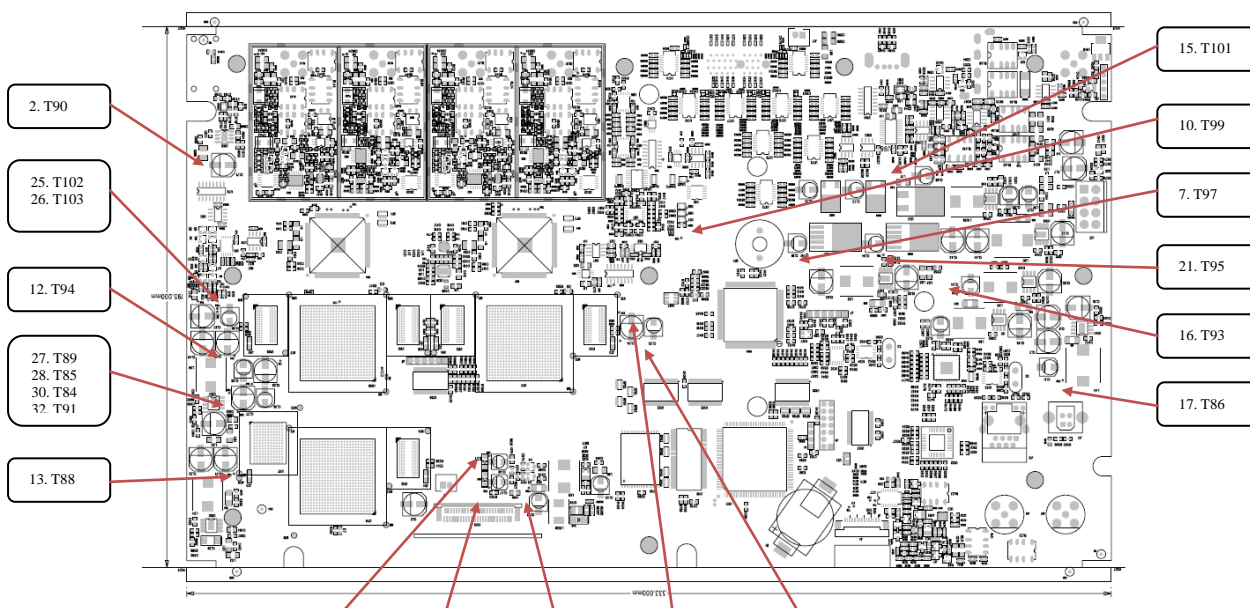


Figure 27 TEST POINTS



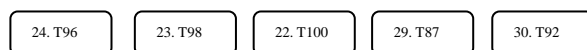


Figure 28 TEST POINTS (Continued)

Troubleshooting Flowchart

The following troubleshooting tree is recommended for quickly locating the defective subsystem or PCB.

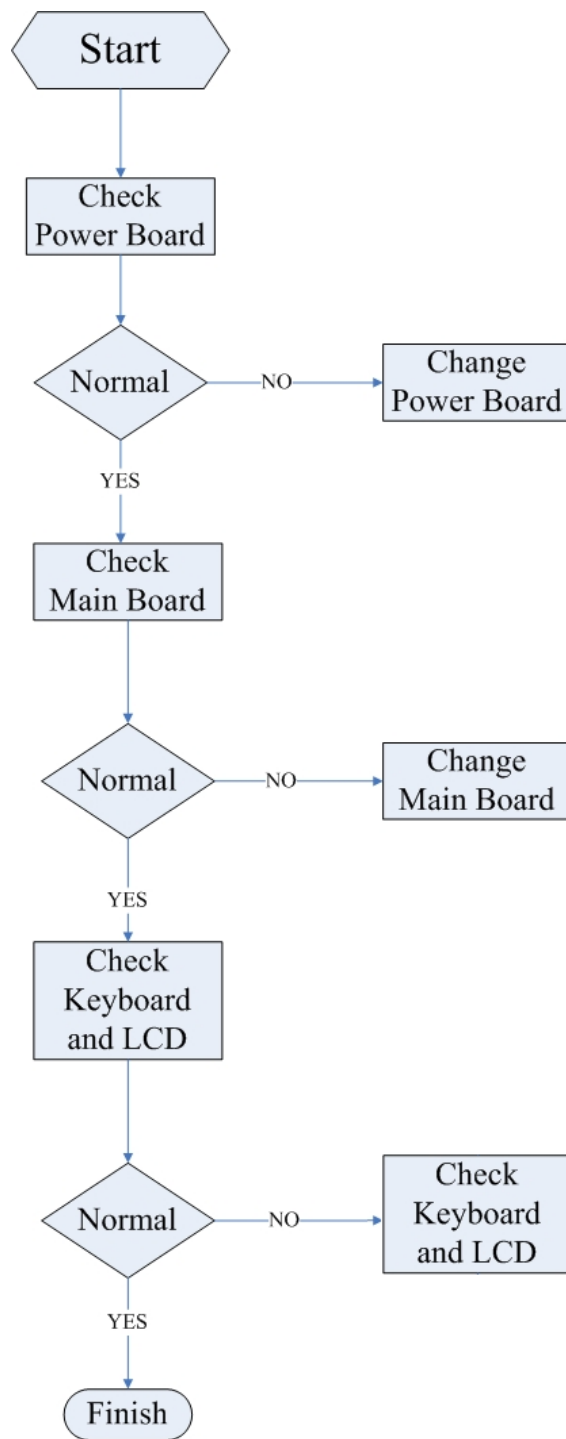


Figure 29 Troubleshooting flowchart

Check the Power Supply

Before performing the power supply testing procedure, please make sure that the oscilloscope is grounded through the protective lead of the power cord. Do NOT touch or disassemble the power supply module without taking safety precautions due to the potential for electric shock. The procedure for testing the power supply is as follows:

1. Disconnect the power cord of the oscilloscope and then check whether the fuse has burned out.
2. Remove metallic cover of the power supply module using a screwdriver, and then connect the power cord.
3. Focus at the Power Connector which contains 8 pins from Pin1 to Pin8 on the main board. Power supply test voltages can be measured at these points using a digital multimeter to check whether they are within the specified range. The corresponding voltage parameters to be tested are listed in the table below:

Table 20 Voltage parameters of the power supply module

Voltage value	Pin	Error
GND	Pin 4, Pin 5, Pin 6	NULL
6.5 V	Pin 1, Pin 2	10%
15 V	Pin 8	10%
AC LINE SIGNAL	Pin 7	NULL
Reserve	Pin 3	NULL

If each tested voltage value is within the specified range as listed in the table above, then the power supply is operating normally. If so, go to the next step.

4. Disconnect the cable connected to the main board, and then again perform the testing procedures as above:

If each tested voltage value is within the specified range as listed in to the table above, then the power supply's load is likely the cause of the out-of-tolerance power supply measured reading. Additional checking or even replacing the main board is required for further testing.

If there is at least one voltage value out of the specified range then the power supply module is defective and will need to be replaced with a new one. For safety considerations, please do not disassemble the power supply module unless another person is present.

Check the Main Board

If removing the main board from the oscilloscope's inside metal shelf is required, place it on a clean insulated mat after removing it. In addition, to avoid any integrated circuits or components on the main board being damaged due to overheating, please cool the main board, if it is under power, whenever possible using a fan. Please follow these procedures for testing the main board:

1. Several types of connectors are used, Fan Connector, LCD Connector, Keyboard Connector. Check to make certain they are connected properly.
2. Make certain that the connectors on the main board are connected properly, then connect the power supply module cable to the appropriate place on the main board. Finally, connect the oscilloscope power cord. Turn on the oscilloscope to check whether the voltage values at test points are within specified range using a digital multimeter. The voltage parameters to be tested are listed in table below:

Table 21 Voltage parameters of the main board

Item	Net	Test Point	Voltage(V)	Error
1	IN15V	CL6 Pin1	15	±5%
2	VCC_15V	T90	15	±5%
3	VFAN_12V	CL52 Pin1	13.4	±5%
4	IN6.5V	CL7 Pin1	6.5	±5%
5	A_+5V	U140 Pin4	5	±5%
6	VCC_6V5C	U163 Pin3	6.5	±5%
7	VCC_A5V	T97	5	±5%
8	VLP_3V	CL71 Pin1	3.32	±5%
9	VCC_6V5	CL9 Pin1	6.5	±5%
10	VCC_1V9	T99	1.92	±5%
11	VCC2_1V5	CL63 Pin1	1.5	±5%
12	VCC1_1V5	T94	1.5	±5%
13	VCC_1V8	T88	1.81	±5%
14	VCC_-6V	CL50 Pin2	-6.5	±5%
15	VEE_-5V	T101	-5	±5%
16	VCC_1V2	T93	1.221	±5%
17	VCC_3V3	T86	3.34	±5%
18	VLED(With LCD)	CL2 Pin1	9	±5%
19	VLEDEE(With LCD)	CL2 Pin2	0.2	±5%
20	VCC_6V5E	U164 Pin3	6.5	±5%
21	VEA_A5V	T95	5	±5%
22	VCC_10V4	T100	10.32	±5%

23	VCC_16V	T98	16	±5%
24	VEE_-7V	T96	-7	±5%
25	VREF_DDR1	T102	0.75	±5%
26	VTT_DDR1	T103	0.75	±5%
27	VREF_QDR	T89	0.9	±5%
28	VTT_QDR	T85	0.9	±5%
29	VREF_DDR2	T87	0.75	±5%
30	VTT_DDR2	T92	0.75	±5%
31	VREF_DDRM	T84	0.75	±5%
32	VTT_DDRM	T91	0.75	±5%

If there is at least one voltage value tested which falls outside the specified range, please turn off the oscilloscope and the power immediately to avoid damage to the internal circuitry or the main board. At this point the Main board will require replacement.

If each voltage value tested is within the specified range, please go to the next step.

3. Check the oscilloscope's clock signal using a separate oscilloscope. Measure the clock at the test point marked "T76" located near the crystal "X3".

If the clock frequency measurement is not 25 MHz, then the fault may come from the main board and a new replacement board is necessary.

If the clock measurement is 25 MHz and the Main board is not operating correctly, please return the oscilloscope to the manufacturer for repair.

Check the Display Module

Here are procedures for testing the Display Module:

1. Disconnect the power cord to make certain the display FPC cable is correctly connected.
2. Connect the power cord and turn on the oscilloscope. If the screen remains dark, then test the voltage value of the backlight; Items "18" "19" in Table 21.

If the test result is within range, check the VGH and VGL of the LCD at test item "23" "24" in Table 3. If the screen remains dark, but voltages are all correct, a new LCD is required.

If the measurement is out of range, a new main board is required.

3. If the screen is abnormally bright, check the backlight and VGH, VGL first as described in step 1 and step 2. Then test the Clock signal pin, located on the main board.

If the Clock signal is as specified, The problem may be due to a defective

display module. Please return the oscilloscope to the manufacturer for service.

Handling General Hardware Failures

The general hardware failures are listed in the table below. Reading the following information can aid in quickly solving some of the simpler possible failures.

Table 22 Troubleshooting general failures

General hardware failures	Method to deal with
No start-up after pressing the ON/OFF button	Check the power cord connection. Also check the power button and power line fuse.
No displaying after power on	Check that the LCD FPC cable is correctly connected.
No response after pressing any button Even though the scope display appears normal.	Check if the keypad cable is correctly connected to the main board.
Every time the oscilloscope is turned on, the Time displayed at the lower right corner restores to its initial value.	Check and replace the button battery on the main board.
The USB interface not working correctly	Check if the rear USB cable is correctly connected.
The LAN interface not working correctly	Check the LAN setting in the I/O set menus, reboot the scope and try again.

Contact SIGLENT

SIGLENT TECHNOLOGIES CO.,LTD

Address: 3/F, building NO.4, Antongda Industrial Zone, 3rd Liuxian
Road, Bao'an District, Shenzhen, P.R.China

Tel: 0086-755-3661 5186

E-mail: sales@siglent.com

<http://www.siglent.com>