

SSG3000X

Signal Generator

Service Manual

SM0803X-E01A

Guaranty and Declaration

Copyright

SIGLENT TECHNOLOGIES CO., LTD All Rights Reserved.

Trademark Information

SIGLENT is the registered trademark of **SIGLENT TECHNOLOGIES CO.,LTD**

Declaration

- ◆ **SIGLENT** products are protected by patent law worldwide
- ◆ **SIGLENT** reserves the right to modify or change parts of or all the specifications or pricing policies at company's sole decision.
- ◆ Information in this publication replaces all previously corresponding material.
- ◆ Any way of copying, extracting or translating the contents of this manual is not allowed without the permission of **SIGLENT**.
- ◆ **SIGLENT** will not be responsible for losses caused by either incidental or consequential in connection with the furnishing, use or performance of this manual as well as any information contained.

Product Certification

SIGLENT guarantees this product conforms to the national and industrial standards in China as well as the ISO9001: 2008 standard and the ISO14001: 2004 standard. Other international standard conformance certification is in progress.

General Safety Summary

Carefully read the following safety precautions to avoid any personal injury or damage to the instrument and any products connected to it. To avoid potential hazards, please use the instrument as specified.

Use Proper AC Power Line

Only the power cord designed for the instrument and authorized by local country should be used.

Ground the Instrument

The instrument is grounded through the protective earth conductor of the power line. To avoid electric shock, please make sure the instrument is grounded correctly before connecting its input or output terminals.

Connect the Probe Correctly.

If a probe is used, do not connect the ground lead to high voltage since it has isobaric electric potential as the ground.

Look Over All Terminals' Ratings

To avoid fire or electric shock, please observe all ratings and label notices on this instrument. Before connecting the instrument, please read the manual carefully to gain more information about the ratings.

Use Proper Overvoltage Protection

Make sure that no overvoltage (such as that caused by a thunderstorm) can enter the product, or else the operator might be exposed to danger of electrical shock.

Electrostatic Prevention

Operate the instrument in an electrostatic discharge protective area environment to avoid damages induced by static discharge. Always ground both the internal and external conductors of the cable to release static before connecting.

Maintain Proper Ventilation

Inadequate ventilation may cause increasing of the instrument's temperature, which will eventually damage the instrument. So keep well ventilated and inspect the intake and fan regularly.

Avoid Exposed Circuit or Components

Do not touch exposed contacts or components when the power is on.

Do Not Operate Without Covers

Do not operate the instrument with covers or panels removed.

Use Only the Specified Fuse.

Keep Product Surfaces Clean and Dry.

To avoid the influence of dust and/or moisture in the air, please keep the surface of the device clean and dry.

Do Not Operate in Wet Conditions.

In order to avoid short circuiting to the interior of the device or electric shock, please do not operate the instrument in a humid environment.

Do Not Operate in an Explosive Atmosphere.

In order to avoid damage to the device or personal injury, it is important to operate the device away from an explosive atmosphere.

Safety Terms and Symbols

Terms on the product. These terms may appear on the product:

DANGER Indicates direct injuries or hazards that may happen.

WARNING Indicates potential injuries or hazards that may happen.

CAUTION Indicates potential damages to the instrument or other property that may happen.

Symbols on the product. These symbols may appear on the product:



**Hazardous
Voltage**



**Protective
Ground**



Warning



**Earth Chassis
Ground**

Contents

Guaranty and Declaration	2
General Safety Summary.....	3
Safety Terms and Symbols	4
Preparation Information	6
Functional check	6
Power-on Inspection	6
Interface Test	7
USB Host Test	7
USB Device Test	9
Performance Verification Test	13
10 MHz output accuracy test	14
Absolute amplitude accuracy test	14
Second Harmonics	17
Internal AM modulation test	19
Internal FM modulation test	21
Internal Φ M modulation test.....	23
Pulse modulation test.....	24
Exit I Q modulation test.....	26
LF AC test	28
LF DC test.....	30
Assembly Procedures	31
Safety Considerations	31
List of Modules	32
Required Tools	32
Disassembly Procedures	33
Removing the Outer Cover.....	33
Removing the IQ Module	34
Removing the Power Module	35
Removing the Control Board.....	35
Removing the Main Board	36
Removing the front panel.....	37
Removing the LCD, Keyboard	38
Contact SIGLENT	39

Preparation Information

Before initiating performance verification or any adjustments, it is recommended to follow these procedures. The following topics are discussed in this chapter.

- How to perform functional checks
- How to operate performance verification test

For more detailed information about the signal generator operation, please refer to the SSG3000X User Manual.

Functional check

There are three types of checks used to determine if the signal generator is operating properly.

Power-on Inspection

The normal operating voltage for SSG3000X series signal generators is in the range of 100-240 VRMS, 50 Hz/ 60 Hz/ 440 Hz.

Please use the power cord provided with the accessories to connect the instrument to the power source as shown in the figure below.

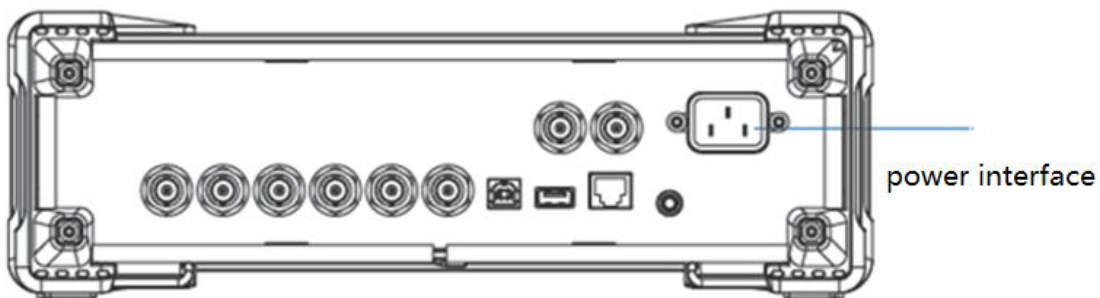

Figure 1-1 Connect power cord

Note: To avoid electric shock, make sure that the instrument is correctly grounded to the earth before connecting AC power.

Press the power-on button located at the lower left corner of the front panel and several keys will illuminate for about 6 seconds. Then, the boot screen will appear on the display.

The front panel is shown in the figure below.



Figure 1-2 Front Panel



Figure 1-3 Rear Panel

Interface Test

The SSG3000X series signal generator is designed with three standard interfaces: USB Host, USB Device, and LAN. Being connected to other instruments via these interfaces enables the signal generator to achieve additional capabilities. In order to ensure the signal generator is operating properly, it is recommended to first test the interfaces.

USB Host Test

To test if the USB Host interface is working normally.

Tools:

- USB memory device (U disk)

Steps:

1. Insert a U disk into the USB Host interface on the front panel of the signal generator.
2. An icon shaped like a U disk appears on the upper right of the screen, as shown in figure below. The icon appearance indicates the U disk has been

successfully recognized.

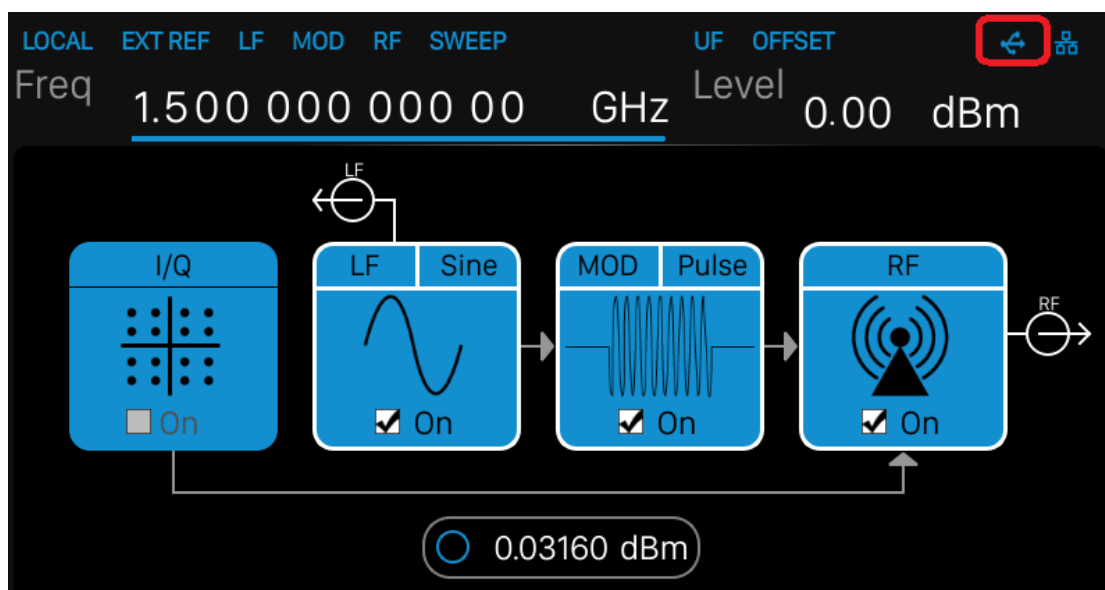

Figure 2-1 USB drive has been properly recognized

USB Device Test

To test if the USB Device interface is operating normally.

Tools:

- A computer with USB interface that is compatible with running National Instruments NI-MAX software
- A standard USB cable (Type A-B)
- NI-MAX software

Steps:

1. Download and install National Instruments NI MAX software by following the installation instructions provided by National Instruments.
2. Connect the signal generator USB Device port and the computer using an USB cable.
3. Run NI MAX software. Click “Device and interface” at the upper left corner of the NI software interface and immediately displays the “USBTMC” device symbol.

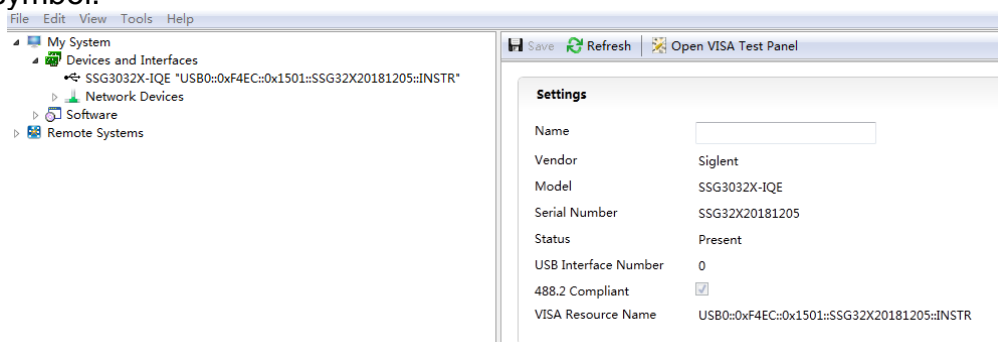

4. Click “Open VISA Test Panel” option button, and then the following Interface will appear. Then click the “Input/Output” option button and click the “Query” option button in order to view the Read operation information.

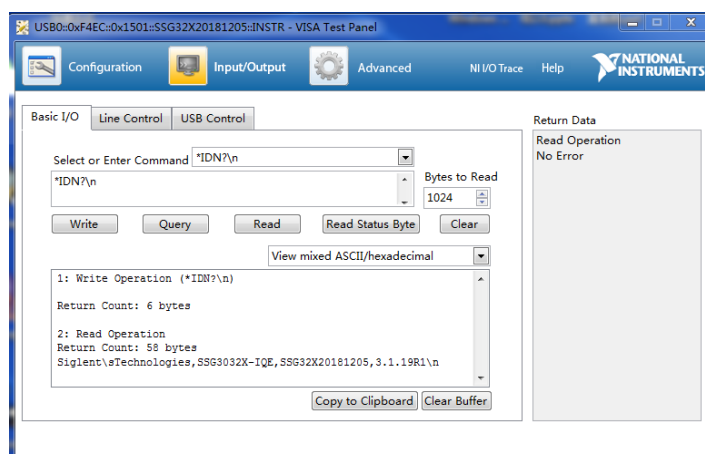

LAN Port Test

Use to test the LAN interface functionality.

Tools:

- A computer with functional LAN interface
- A standard LAN cable

Steps:

1. Connect the signal generator and the computer using a LAN cable via LAN interface.
2. Press **System** -> **Interface** -> **LAN**, Set DHCP State ON, as the figure below shows. The signal generator will set IP Address and Subnet Mask and Gateway automatically in this network.

Write down the displayed IP address. It will be used in later steps.

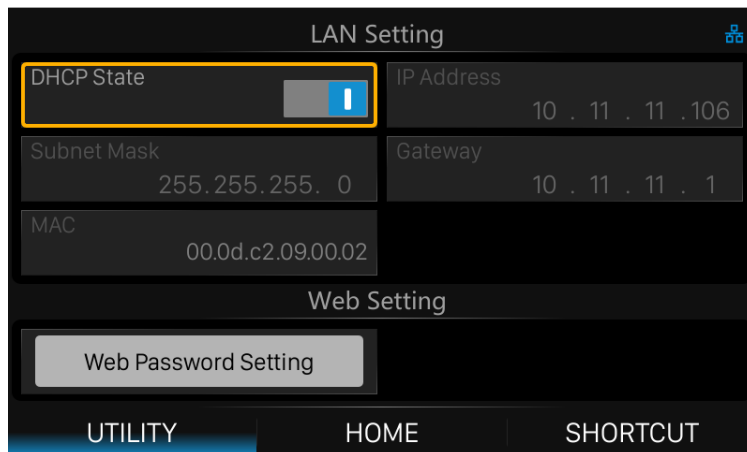
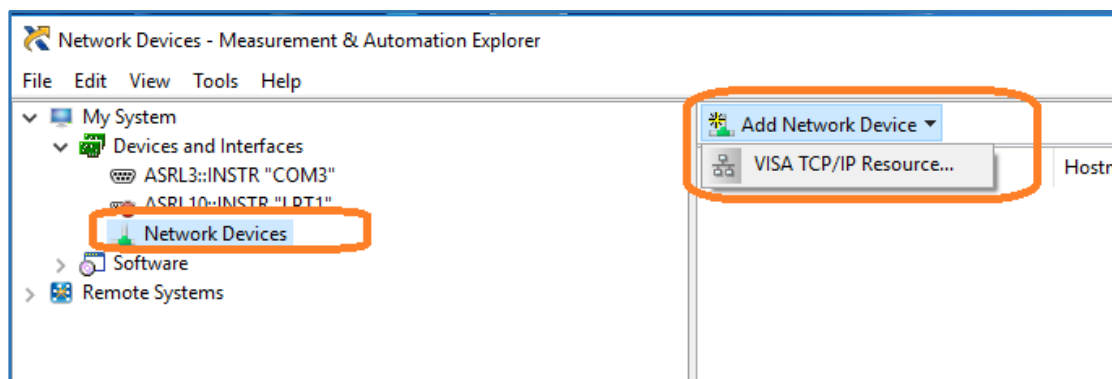

Figure 2-2 IP configuration interface

3. Run NI max software. Click “Device and interfaces” in the upper left corner of the NI software interface, select “Network Devices”, Add Network Device, and select VISA TCP/IP Resource as shown:.



4. Select Manual Entry of LAN instrument, select Next, and enter the IP address as shown. Click Finish to establish the connection:

NOTE: Leave the LAN Device Name BLANK or the connection will fail.

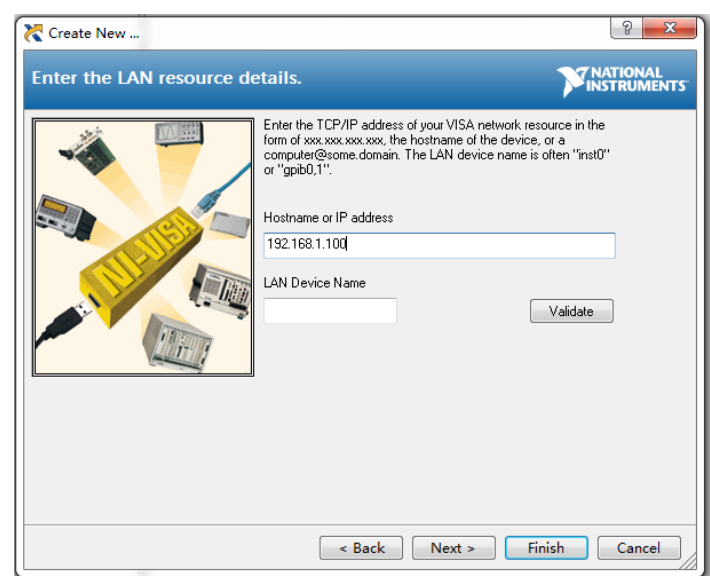
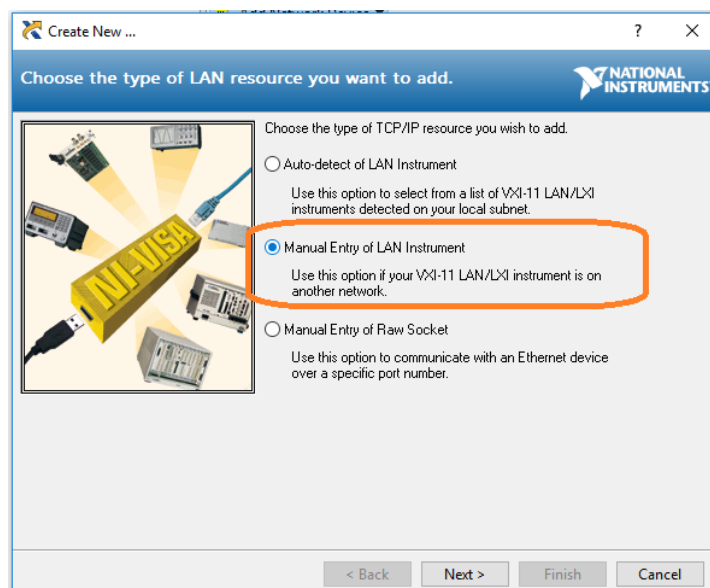

4. After a brief scan, the connection should be shown under Network Devices:

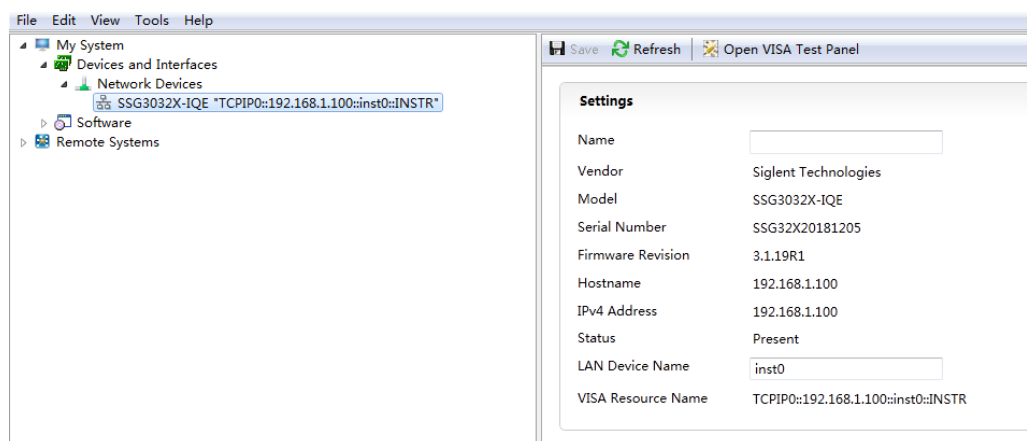

5. Right-click on the product and select Open NI-VISA Test Panel:
6. Click “Input/Output” option button and click “Query” option button. If everything is connected and operating correctly, the Read operation information returned shown below will appear.

NOTE: The *IDN? Command (known as the Identification Query) should return the instrument manufacturer, instrument model, serial number, and other identification information.

Performance Verification Test

This chapter explains testing the signal generator in order to verify performance specifications. For accurate test results, please let the test equipment and the signal generator warm up 30 minutes before testing.

Below is the required equipment:

Table 3-1 Test equipment

Equipment	Specification	Qty.	Recommended
Signal Analyzer	9 kHz~3.2 GHz	1	Keysight N9020
Power Meter	6 GHz	1	R&S NRP6A
Frequency Counter	10 MHz	1	SIGLENT SDG1050 With OCXO
Attenuator	10 dB	1	
RF switch	18 GHz	1	
SMA-N Cable	6 GHz	3	
BNC Cable	2 GHz	1	

10 MHz output accuracy test

Specification

Reference frequency	10.000000 MHz
Initial calibration accuracy	<0.2 ppm



Figure 3-6 Connecting test instruments for frequency accuracy

Steps:

1. Connect ref out port of the signal generator to the channel A of the SDG6000X. The SDG6000X should be connected to an external OXCXO 10 MHz reference oscillator.
2. Set the SDG6000x to frequency counter mode, and set frequency ref to 10.000000 MHz
3. Check if the frequency deviation ≤ 0.2 ppm

Record:

Table 2-1 Frequency deviation

Frequency	Frequency Deviation	Pass/Fail
10.000000 MHz		

Absolute amplitude accuracy test

Specification

Level error (ALC on ,temperature is 20°C~30°C)			
	+13 dBm~-50 dBm	-50 dBm~-90 dBm	-90 dBm~-110 dBm
9 kHz \leq f<100 kHz	≤ 0.9 dB ≤ 0.7 dB(typ.)	≤ 1.1 dB ≤ 0.7 dB(typ.)	≤ 1.1 dB ≤ 0.7 dB(typ.)
100 kHz \leq f \leq 3.2 GHz	≤ 0.7 dB ≤ 0.5 dB(typ.)	≤ 0.7 dB ≤ 0.5 dB(typ.)	≤ 1.1 dB ≤ 0.7 dB(typ.)

Test Devices

1. Power Meter $\times 1$
2. Dual-N Cable $\times 1$
3. Dual-BNC Cable $\times 1$
4. Signal generator $\times 1$

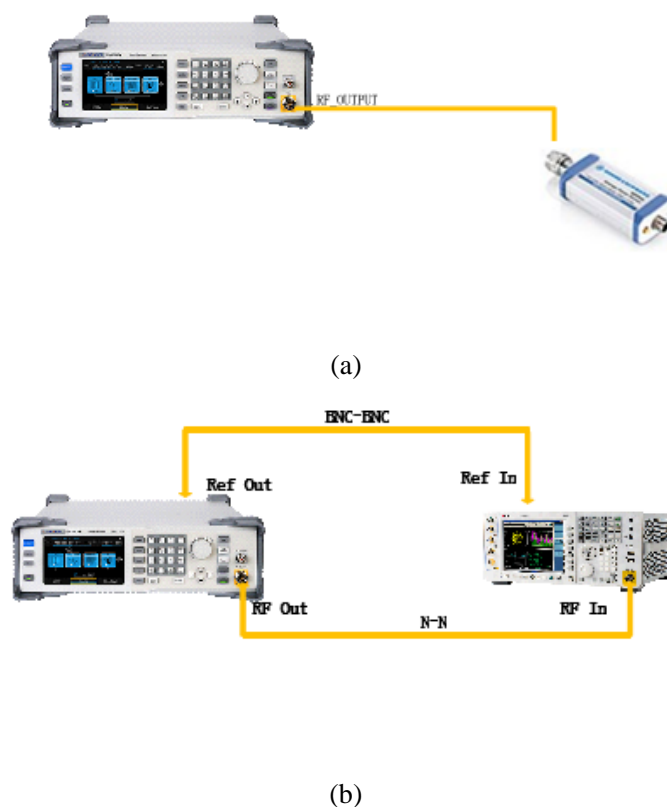

Figure 3-1 Absolute amplitude accuracy connections

Test Procedures

1. Connect the output terminal of the SSG3000X with the power meter, as shown in Figure 3-1 (a).
2. Set the SSG3000X to output a sine waveform with -10 dBm amplitude. Then modify the output frequency of the SSG3000X according to Table 2-2 and enable the RF output switch **RF**.
3. Modify the frequency of the power meter accordingly each time the output frequency of the SSG3000X is modified. Read the amplitude measurement value **A1** and record it to the test record form.
4. Disconnect the SSG3000X and the power meter. Connect the **[10 MHz OUT]** terminal of the signal analyzer with the **[EXT REF IN]** terminal at the rear panel of the signal generator using dual-BNC cable to synchronize the two instruments.
5. Connect the output terminal of the SSG3000X with the input terminal of the signal analyzer using dual-N cable as shown in Figure 3-1 (b).
6. Configure the signal analyzer:
 - a) Select the external frequency reference input.
 - b) Set the span to 100 Hz.
 - c) Set the reference level to -20 dBm.
 - d) Set the input attenuation to 10 dB.
 - e) Set the resolution bandwidth to 1 Hz.
 - f) Set the self-calibration to normal and perform all of the calibration items.
7. Set the output frequency of the SSG3000X and the center frequency of the signal analyzer according to Table 2-2 (the center frequency of the signal analyzer corresponds to output frequency of the SSG3000X).
8. Each time the center frequency is changed, wait for the instrument to finish a sweep and press **Peak Search** to find the maximum peak. Then record the result **A2** to the test record form.

9. **System Error** (the input attenuation of the signal analyzer is 10 dB) = **A2 - A1** and record the measurement result.

10. Keep the connection shown in Figure 3-1 (b) unchanged, press **Mode Preset** to restore the signal analyzer to its factory setting and set the output amplitude of the SSG3000X according to Table 2-3.

11. Each time the output amplitude is changed, set the output frequency of the SSG3000X and the center frequency of the signal analyzer according to Table 2-2 (the center frequency of the signal analyzer corresponds to output frequency of the SSG3000X).

12. Each time the center frequency is changed, wait for the instrument to finish a sweep; then, press **Peak Search** to find the maximum peak and record the measurement result **A3** to the test record form.

Note: when the output amplitude of the SSG3000X is -10 dBm, the measurement result **A3**, namely, the measurement value **A2** of the signal analyzer in step 9.

13. Calculate the **Global Error = A3 - Reference Value** and record the result.

14. Calculate the amplitude accuracy using the formula **Amplitude Accuracy = |Global Error - System Error|** and compare the calculation result with the specification.

Table 2-2 Output Frequency of the SSG3000X

	Output Frequency						
SSG3000X	103kHz	1.33MHz	51.33MHz	533MHz	1.933GHz	2.433GHz	2.933GHz

Note: When the frequency of the signal measured is less than 10 MHz, make certain the signal analyzer is in the DC coupling mode to ensure the measurement accuracy.

Table 2-3 Output Amplitude of the SSG3000X

Output amplitude		
-10 dBm	-50 dBm	-90 dBm

Test Record Form

Table 2-4

SSG3000X Output Frequency	Power Meter Measurement Value A1	Signal Analyzer Measurement Value A2	System Error
103 kHz			
1.33 MHz			
51.33 MHz			
533 MHz			
1.933 GHz			
2.433 GHz			
2.933 GHz			

Table 2-5

Reference Value	-10 dbm				
SSG3000X Output	Signal Analyzer Measurement Value A3	Global Error	Amplitude Accuracy	Limit	Pass/Fail
103 kHz					
1.33 MHz					

51.33 MHz				<0.7		
533 MHz						
1.933 GHz						
2.433 GHz						
2.933 GHz						

Table 2-6

Reference Value	-50 dbm				
SSG3000X Output	Signal Analyzer Measurement Value A3	Global Error	Amplitude Accuracy	Limit	Pass/Fail
103 kHz				<0.7	
1.33 MHz					
51.33 MHz					
533 MHz					
1.933 GHz					
2.433 GHz					
2.933 GHz					

Table 2-7

Reference Value	-90 dbm				
SSG3000X Output	Signal Analyzer Measurement Value A3	Global Error	Amplitude Accuracy	Limit	Pass/Fail
103 kHz				<0.7	
1.33 MHz					
51.33 MHz					
533 MHz					
1.933 GHz					
2.433 GHz					
2.933 GHz					

Second Harmonics

Specification

Spectral purity		
Harmonics	CW mod, 1 MHz<f<3.2 GHz, Level ≤13 dBm	<-30 dBc

Test Devices

1. PC × 1
2. Signal Analyzer × 1
3. BNC-BNC Cable × 1
4. N-N Cable × 1

Test Connection Diagram

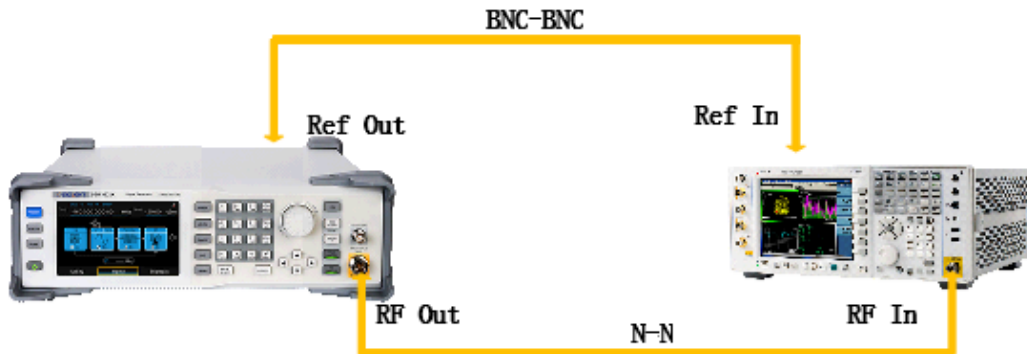

Test Procedures

1. Synchronize the SSG3000X and signal analyzer. Connect the RF output terminal of the SSG3000X with the RF input terminal of the signal analyzer.
2. Configure the SSG3000X:
 - a. Set the output frequency follow the table 2-8
 - b. Set the output level of the SSG3000X to 13dBm
3. Configure the signal analyzer:
 - a. Preset.
 - b. Set the input attenuation to auto.
 - c. Set the reference level to the SSG3000X power plus 2.
 - d. Switch the preamp to off.
 - e. Set the center frequency to the SSG3000X frequency.
 - f. Set the span to 5 kHz.
 - g. Set the resolution bandwidth to 100 Hz.
 - h. Press **Peak** and get the power result as P0.
 - i. Set the center frequency to the SSG3000X frequency $\times 2$.
 - j. Repeat steps f and g.
 - k. Press **Peak** and get the power result as P1.
 - l. Record the P0-P1.
4. The P0-P1 is the **Second Harmonic Distortion**. And compare the measurement result with the specification.

Table 2-8

Freq(Hz)	Set Power(dBm)	2th Harmonic Power(dBm)	Diff(dB)	Pass Range(dB)	Pass/Fail
1 MHz				>30.0	
52 MHz				>30.0	
112 MHz				>30.0	
312 MHz				>30.0	
512 MHz				>30.0	
912 MHz				>30.0	
1212 MHz				>30.0	
1512 MHz				>30.0	
1912 MHz				>30.0	

2512 MHz				>30.0	
2912 MHz				>30.0	

Internal AM modulation test

Specification

Amplitude Modulation		
Modulation source	internal, external, internal + external	
AM depth setting range	0 %~100 %	
Resolution of m ^[1] setting	0.1 %	
AM Accuracy	f _{mod} =1 kHz	< 4 % of m setting+1 %
AM Distortion	f _{mod} =1 kHz, m≤30 %, level<0 dBm	<3 % (typ.)

Note: [1] m represents the AM depth.

Test Devices

1. Signal Analyzer × 1
2. Dual-BNC Cable × 1
3. Dual-N Cable × 1

Test Connection Diagram

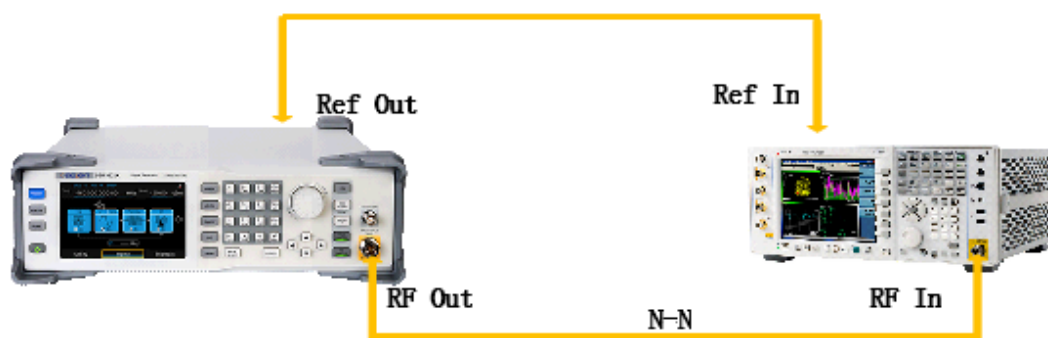

Test Procedures

1. Synchronize the SSG3000X and signal analyzer. Connect the RF output terminal of the SSG3000X with the RF input terminal of the signal analyzer as shown in above figure.
2. Configure the SSG3000X:
 - 1) Set the frequency to 1 GHz.

SIGLENT

- 2) Set the amplitude to -10 dBm.
 - 3) Enable the AM switch.
 - 4) Set the modulation source to internal.
 - 5) Set the modulation depth to 30%.
 - 6) Set the modulation rate to 1 kHz.
 - 7) Set the modulation waveform to "Sine".
 - 8) Enable the modulation output switch **MOD**.
 - 9) Enable the RF output switch **RF**.
3. Configure the Signal Analyzer:
- 1) Select the **Analog Demod** mode.
 - 2) Select the **AM** analog demodulation.
 - 3) Set the span to 200 kHz.
4. Press **Meas Setup** -> **Auto BW & Scale** and then read the results of the demodulated signal in the AM analog demodulation test interface of the signal analyzer. Record the measurement results **(Pk - Pk)/2** and **Distortion**.

Note: the value **(Pk - Pk)/2** represents the peak of the low frequency signal after AM demodulated.

5. Calculate the modulation accuracy and the distortion using the formulas:

$$\text{AM Accuracy} = |(\text{Pk} - \text{Pk})/2 - 30\%|,$$

$$\text{AM Distortion} = \text{Distortion}.$$

Then, compare the calculation results with the specifications.

Test Record Form

SSG3000X Output Frequency	Test Item	Measure ment	Calculated Result	Limit	Pass/ Fail	
1 GHz	AM Accuracy ^[1]			< 4 % of m setting+1 %		
	AM Distortion ^[2]			<3 % (typ.)		

Note:

[1] AM Accuracy = $|(\text{Pk} - \text{Pk})/2 - 30\%|$

[2] AM Distortion = Distortion value in the AM analog demodulation test interface

Internal FM modulation test

Specification

Frequency Modulation		
Modulation source	internal, external, internal + external	
Maximum FM deviation	$N^{[1]} \times 1$ MHz (typ.)	
Resolution of $m^{[2]}$ setting	0.1% of m setting or 1 Hz, whichever is larger	
FM Deviation Accuracy	$f_{\text{mod}} = 1$ kHz, internal	<2% of m setting+20 Hz
FM Distortion	$f_{\text{mod}} = 1$ kHz, $m = N \times 1$ MHz	<0.5 % (nom.)

Note:

[1] Please refer to the value of N in the "Frequency Bands" section of the SSG3000X Data Sheet.

[2] m represents the FM deviation.

Test Devices

1. Signal Analyzer × 1
2. Dual-BNC Cable × 1
3. Dual-N Cable × 1

Test Connection Diagram

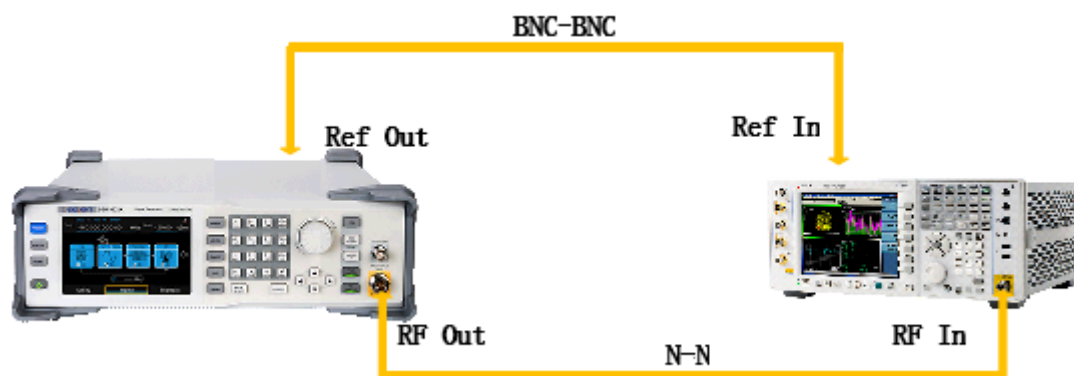

Test Procedures

6. Synchronize the SSG3000X and signal analyzer. Connect the RF output terminal of the SSG3000X with the RF input terminal of the signal analyzer as shown in above figure.
7. Configure the SSG3000X:
 - 1) Set the frequency to 1 GHz.

- 2) Set the amplitude to -10 dBm.
 - 3) Enable the FM switch.
 - 4) Set the modulation source to internal.
 - 5) Set the modulation deviation to 500 kHz.
 - 6) Set the modulation rate to 1 kHz.
 - 7) Set the modulation waveform to "Sine".
 - 8) Enable the modulation output switch **MOD**.
 - 9) Enable the RF output switch **RF**.
8. Configure the Signal Analyzer:
- 1) Select the **Analog Demod** mode.
 - 2) Select the **FM** analog demodulation.
 - 3) Press **Meas Setup** -> **Auto BW & Scale**.
 - 4) Set the span to 2 MHz.
 - 5) Set the Channel BW to 1.5 MHz.
 - 6) Set the RF Res BW to 300 Hz.
9. Read the results of the demodulated signal in the FM analog demodulation test interface of the signal analyzer. Record the measurement results **(Pk - Pk)/2** and **Distortion**.

Note: the value **(Pk - Pk)/2** represents the peak of the low frequency signal after FM demodulated.

10. Calculate the modulation accuracy and the distortion using the formulas:

FM Accuracy = |(Pk - Pk)/2 – 500 kHz|,

FM Distortion = Distortion.

Next, compare the calculation results with the specifications.

Test Record Form

SSG3000X Output Frequency	Test Item	Measure ment	Calculated Result	Limit	Pass/ Fail	
1 GHz	FM Accuracy ^[1]			<2% of m setting+20 Hz		
	FM Distortion ^[2]			<0.5 % (nom.)		

Note:

[1] FM Accuracy = |(Pk - Pk)/2 – 500 kHz|

[2] FM Distortion = Distortion value in the FM analog demodulation test interface

Internal Φ M modulation test

Specification

Phase Modulation		
Modulation source	internal, external, internal + external	
Maximum Φ M deviation	$N^{[1]} * 5$ rad	
Resolution of $m^{[2]}$ setting	0.1 % of m setting or 0.01 rad, whichever is larger	
Φ M Deviation Accuracy	$f_{mod} = 1$ kHz, internal, deviation $\leq N * 5$ rad	< 2 % of m setting + 0.05 rad
Φ M Distortion	$f_{mod} = 1$ kHz, deviation $\leq N * 5$ rad	< 0.5 % (nom.)

Note:

[1] Please refer to the value of N in the “Frequency Bands” section of the SSG3000X Data Sheet.
 [2] m represents the Φ M deviation.

Test Devices

1. Signal Analyzer x 1
2. Dual-BNC Cable x 1
3. Dual-N Cable x 1

Test Connection Diagram

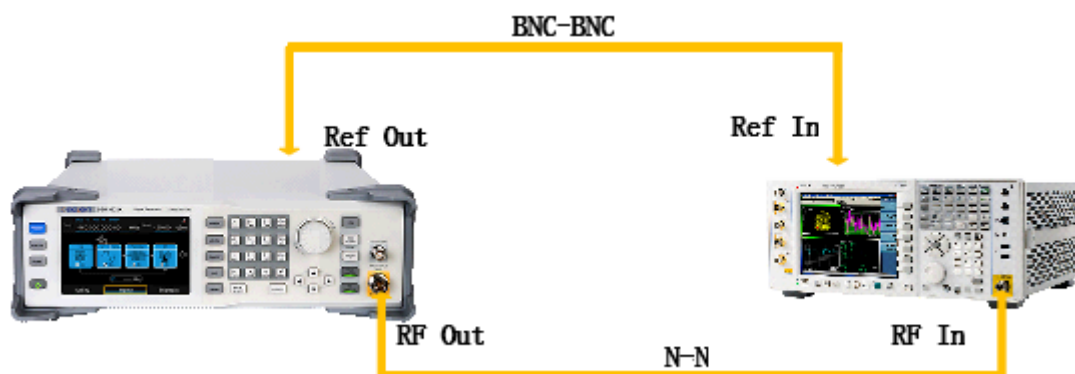

Test Procedures

11. Synchronize the SSG3000X and signal analyzer. Connect the RF output terminal of the SSG3000X with the RF input terminal of the signal analyzer as shown in above figure.
12. Configure the SSG3000X:
 - 1) Set the frequency to 1 GHz.
 - 2) Set the amplitude to -10 dBm.

- 3) Enable the Φ M switch.
- 4) Set the modulation source to internal.
- 5) Set the modulation deviation to 2.5 rad.
- 6) Set the modulation rate to 1 kHz.
- 7) Set the modulation waveform to "Sine".
- 8) Enable the modulation output switch **MOD**.
- 9) Enable the RF output switch **RF**.

13. Configure the Signal Analyzer:

- 1) Select the **Analog Demod** mode.
- 2) Select the **Φ M** analog demodulation.

14. Press **Meas Setup** -> **Auto BW & Scale** and then read the results of the demodulated signal in the Φ M analog demodulation test interface of the signal analyzer. Record the measurement results **(Pk - Pk)/2** and **Distortion**.

Note: the value **(Pk - Pk)/2** represents the peak of the low frequency signal after Φ M demodulated.

15. Calculate the modulation accuracy and the distortion using the formulas:

Φ M Accuracy = |(Pk - Pk)/2 - 2.5 rad|,

Φ M Distortion = Distortion.

Then, compare the calculation results with the specifications.

Test Record Form

SSG3000X Output Frequency	Test Item	Measure ment	Calculated Result	Limit	Pass/ Fail
1 GHz	Φ M Accuracy ^[1]			<2% of m setting+0.05 rad	
	Φ M Distortion ^[2]			<0.5 % (nom.)	

Note:

[1] Φ M Accuracy = |(Pk - Pk)/2 - 2.5 rad|

[2] Φ M Distortion = Distortion value in the Φ M analog demodulation test interface

Pulse modulation test

Specification

Pulse modulation	
Modulation source	internal, external
On/off ration	1 MHz <f<3.2 GHz > 70 dBc

Raise/fall time (10%/90%)	10% to 90% of RF amplitude	<50 ns
Pulse repetition time	Setting range	40 ns~300 s

Test Devices

1. Signal Analyzer x 1
2. Dual-BNC Cable x 1
3. Dual-N Cable x 1

Test Connection Diagram

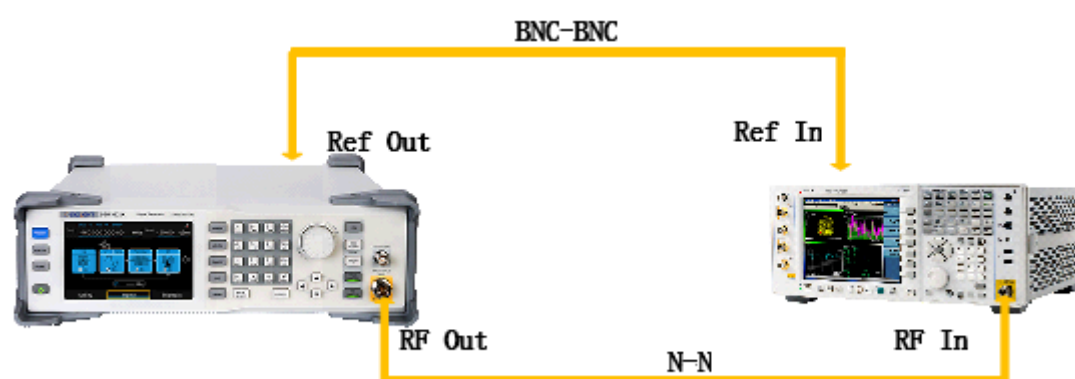

Test Procedures

16. Synchronize the SSG3000X and signal analyzer. Connect the RF output terminal of the SSG3000X with the RF input terminal of the signal analyzer as shown in above figure.
17. Configure the SSG3000X:
 - 10) Set the frequency to 1 GHz.
 - 11) Set the level to -10 dBm.
 - 12) Enable the pulse state.
 - 13) Set the pulse source to internal.
 - 14) Set the pulse mode to single.
 - 15) Set the pulse period to 1s.
 - 16) Set the pulse width to 0.5s.
 - 17) Set the pulse trigger to Key.
 - 18) Enable the modulation output switch **MOD**.
 - 19) Enable the RF output switch **RF**.
18. Configure the Signal Analyzer:

- 4) Set the center frequency to 1Ghz.
- 5) Set the span to 0 Hz.
- 6) Set the reference level to 0 dBm.
- 7) Set the input attenuation to 10 dB.
- 8) Set the resolution bandwidth to 100 Hz.
- 9) Set the video bandwidth to 100kHz.
- 10) Set the sweep time to 1s.
- 11) Set the trigger mode to video trigger.

19. Press **Click to trigger** on the display of the SSG3000X to start a pulse sweep and wait for the analyzer to finish a sweep, then press **Peak Search** to locate the peak

20. Press **Marker**->**Delta**->input 0.5s, then press **Click to trigger** on the display of the SSG3000X again. record the **Delta** value which equal to the - **On/Off Ratio**

Test Record Form

SSG3000X Output Frequency	Test Item	Measurement	Calculated Result	Limit	Pass/ Fail
1 GHz	On/Off Ratio			> 70 dBc	

Note:

[1] Calculation Result = -Delta.

Exit I Q modulation test

Specification

IQ modulation feature	
Modulate source ^[5]	external
Band width	base band I or Q <100 MHz(typ.) RF(I+Q)<200 MHz(typ.)
Full-scale input	$\sqrt{I^2 + Q^2} = 0.5V_{rms}$
EVM	16QAM^[5], Root cosine filler(a =0. 22), 5 MSps, level ≤0 dBm 10 MHz<f ≤1.5 GHz , EVM ≤0.7 %(nom.) 1.5 GHz<f ≤3.2 GHz , EVM ≤1.2 %(nom.)
	QPSK, Root cosine filler (a =0. 22), 5 MSps, level ≤0 dBm 10 MHz<f ≤1.5 GHz , EVM ≤0.7 %(nom.) 1.5 GHz<f ≤3.2 GHz , EVM ≤1.2 %(nom.)

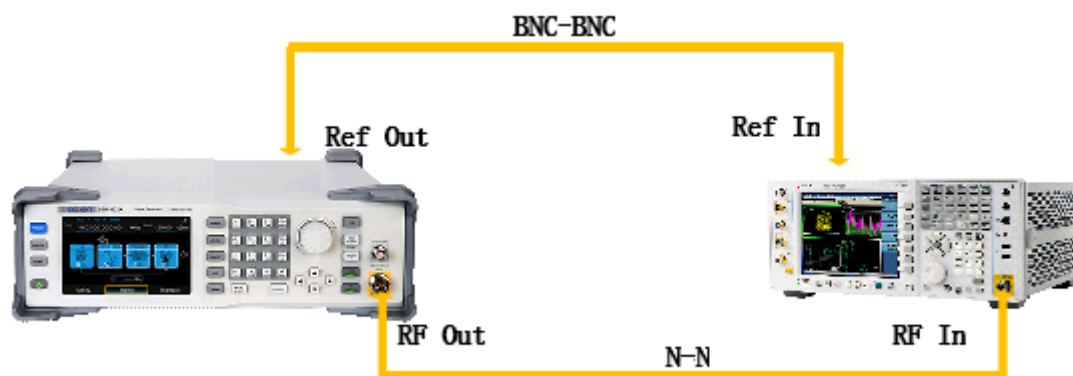

Test Procedures

1. Synchronize the SSG3000X and signal analyzer. Connect the RF output terminal of the SSG3000X with the RF input terminal of the signal analyzer. Connect the USB DEVICE connector of the SSG3000X with the USB interface of the PC as shown in figure.
2. Install the EasyIQ software to the PC. Configure the IQ modulation wave table using the EasyIQ software.
3. Configure the wave Data Source, the modulation type of the wave, the filter parameter of the wave.

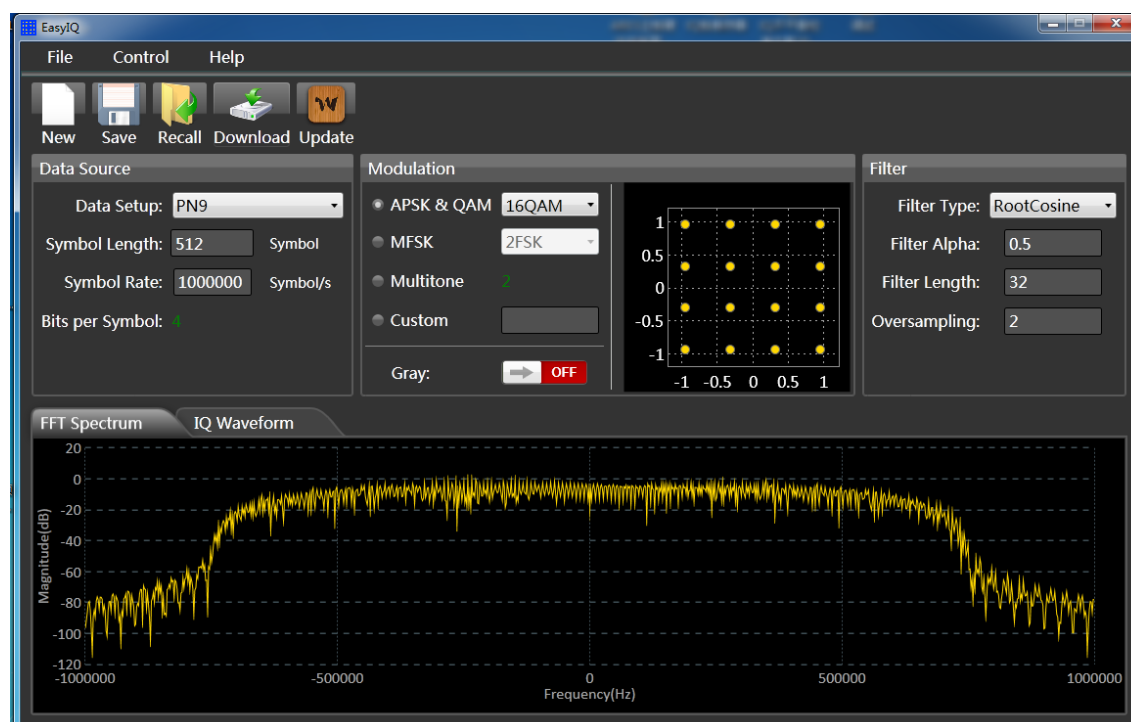

Then download the currently generated wave to the SSG3000X.

4. Configure the SSG3000X:
 - a) Set the frequency to 800 MHz.
 - b) Set the level to 3 dBm.
 - c) Press I/Q to enter the I/Q source settings interface.
 - d) Enable the I/Q state switch.
 - e) Set the source to internal.

- f) Enable the modulation output switch mod.
- g) Enable the RF output switch RF.

- 5. Configure the signal analyzer:
 - a) Press mode—89601 VSA to enter the vector signal analysis interface.
 - b) Press demodulator—digital demod
 - c) Press grid 2*2 to show the EVM value.
 - d) Press demod properties to display digital demodulation properties.
 - e) Press QAM Formats to select QAM16.
 - f) Set symbol rate to 4 MHz.
 - g) Select the filter type to root raised cosine.
 - h) Select the reference filter to raised cosine.
 - i) Set the roll of factor(a) to 0.22.
 - j) Read the EVM value.
 - k) Display the center frequency.
 - l) Record measurement result and compare it with the specification.

LF AC test

Specification

Internal modulation generator(LF)	
Frequency response	Sine wave < 0.3 dB

Test Devices

- 1. Power Sensor × 1
- 2. N-BNC Cable × 1
- 3. USB Cable × 1

Test Connection Diagram

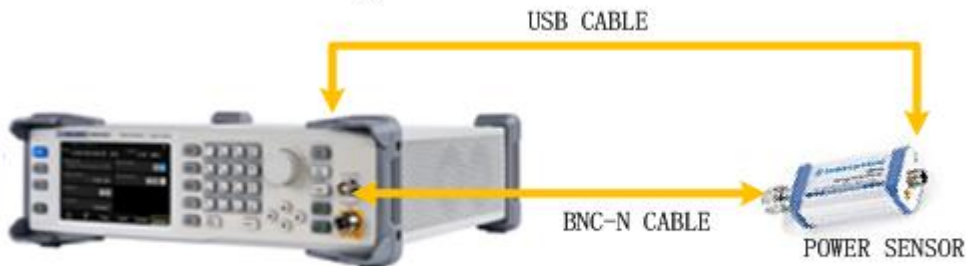

Test Procedures

- 1. Connect the LF output terminal of the SSG3000X with the input terminal of the power sensor. Connect the [USB ] connector of the SSG3000X with the USB interface

of the power sensor as shown in figure above.

2. Enable LF output switch. Select Sine waveform of the generator and set the amplitude to 0 dBm and then step through the frequencies listed below in sequence. Then, set the amplitude to -20 dBm and repeat the frequency steps.

Output Voltage	0 dBm		-20 dBm	
Frequency	Power Meter Measurement Value	Spec Range (dBm)	Power Meter Measurement Value	Spec Range (dBm)
100 kHz		-0.3 ~ 0.3		-20.3 ~ -19.7
200 kHz				
300 kHz				
400 kHz				
500 kHz				
600 kHz				
700 kHz				
800 kHz				
900 kHz				
1 MHz				

3. Compare the value measured from Power Sensor shown on the SSG3000X interface with the spec range shown in the table above.

LF DC test

Specification

DC Offset error	$\pm(1\%+3\text{ mV})$
-----------------	------------------------

Test Devices

1. Digital Multimeter × 1
2. Banana-to-single-BNC Cable × 1 s

Test Connection Diagram



Test Procedures

1. Connect the LF output terminal of the SSG3000X with the Voltage input terminal of the Digital Multimeter as shown in figure above.
2. Enable LF output switch. Select DC waveform of the generator and set the instrument to each output value described in the table below and measure the output voltage with the DMM.

DC Offset	DMM Measurement Value	Spec Range $\pm(1\%+3\text{ mV})$
-2 V		-2.017 V ~ -1.983 V
-1 V		-1.007 V ~ -0.993 V
-100 mV		-102 mV ~ -98 mV
-10 mV		-12.9 mV ~ -7.1 mV
0 V		-3 mV ~ 3 mV
10 mV		6.9 mV ~ 13.1 mV
100 mV		96 mV ~ 104 mV
1 V		0.987 V ~ 1.013 V
2 V		1.977 V ~ 2.023 V

Note: The output impedance of generator is $50\ \Omega$ and the input impedance of DMM is high-z, so the measured value should divide by 2 to get a accurate value.

3. Compare the measured voltage with the spec range shown in the table above.

Assembly Procedures

This chapter describes how to remove the major modules from the SSG3000X signal generator. To install the removed modules or replace new modules, please follow the corresponding operating steps in reverse order.

This chapter includes the following topics:

- **Safety Considerations** which describes security information needed to consider while operating.
- **List of Modules** in which the modules to remove are listed.
- **Required Tools** which describes the tools needed to perform the procedures.
- **Disassembly Procedures** which describes in detail how to remove and install the modules.

Safety Considerations

Only qualified personnel should perform the disassembly procedures. Whenever possible, disconnect the power before you begin to remove or replace the modules. Otherwise, possible personal injuries or damages to the components may occur.

Avoid Electrical Shock Hazardous voltages exist on the LCD module and power supply module. To avoid electrical shock, first disconnect the power cord from the analyzers and then wait at least three minutes for the capacitors in the analyzers to discharge before you begin disassembly.

Preventing ESD Electrostatic discharge (ESD) can damage electronic components. When doing any of the procedures in this chapter, use proper ESD precautions. As a minimum, place the analyzers on a properly grounded ESD mat and wear a properly grounded ESD strap.

List of Modules

The following removable modules are listed in the order of performing disassembly procedures.

Table 4-1 List of modules

Number of Module	Module
1	Outer cover
2	Front-Panel
3	Power module
4	Main board
5	Zynq board
6	IQ-E board
7	RF connector
8	LCD ,Keyboard

Required Tools

Use these tools to remove or replace the modules in the analyzers:

- Multifunctional screwdriver
- Antistatic gloves
- Custom screw hexagonal nut tool or long nose pliers

Disassembly Procedures

This section describes how to remove and install the modules listed above in the signal generator in detail. Complete disassembly will be best achieved using the following operating steps.

Removing the Outer Cover

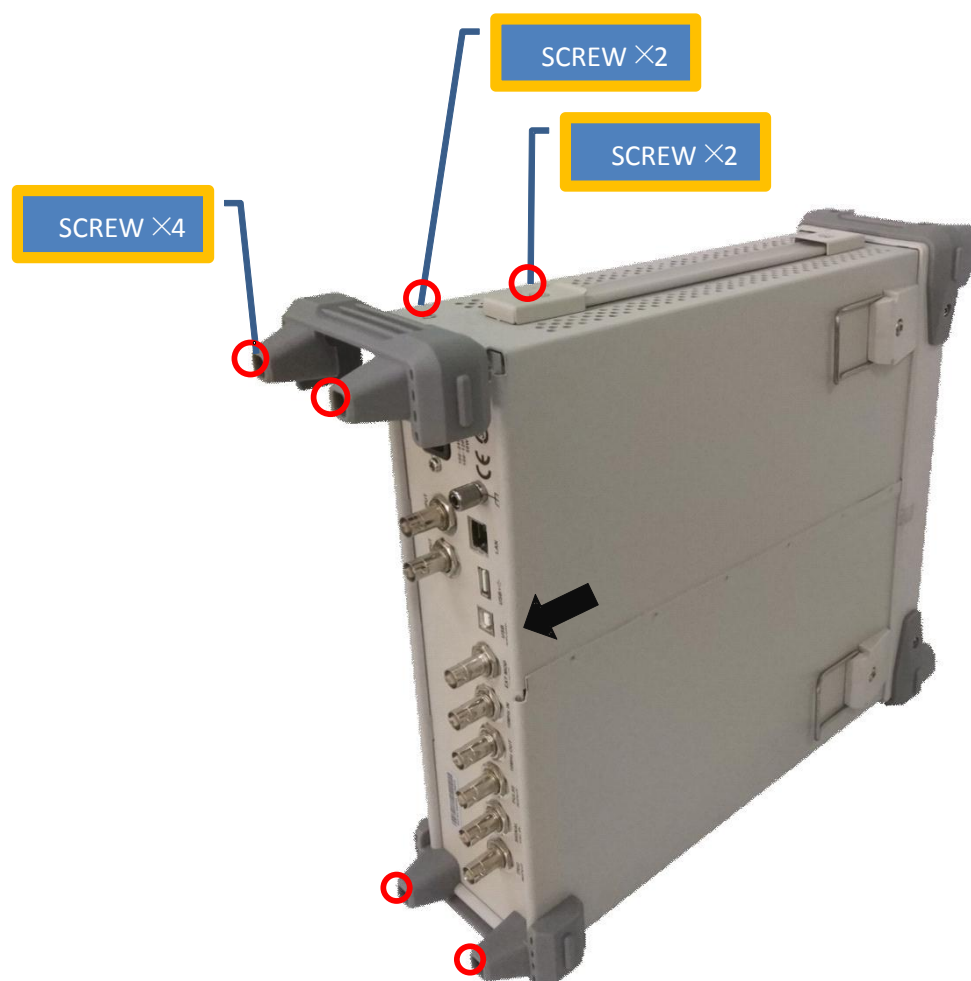

Figure 4-1 Removing the Rear Panel Screws

Removal steps:

1. Remove the screws as shown in figures above.
2. Press the place of the outer cover as the arrows point in the first figure and remove the outer cover from the machine.

To install the outer cover, please perform these steps in reverse order.

Removing the IQ Module

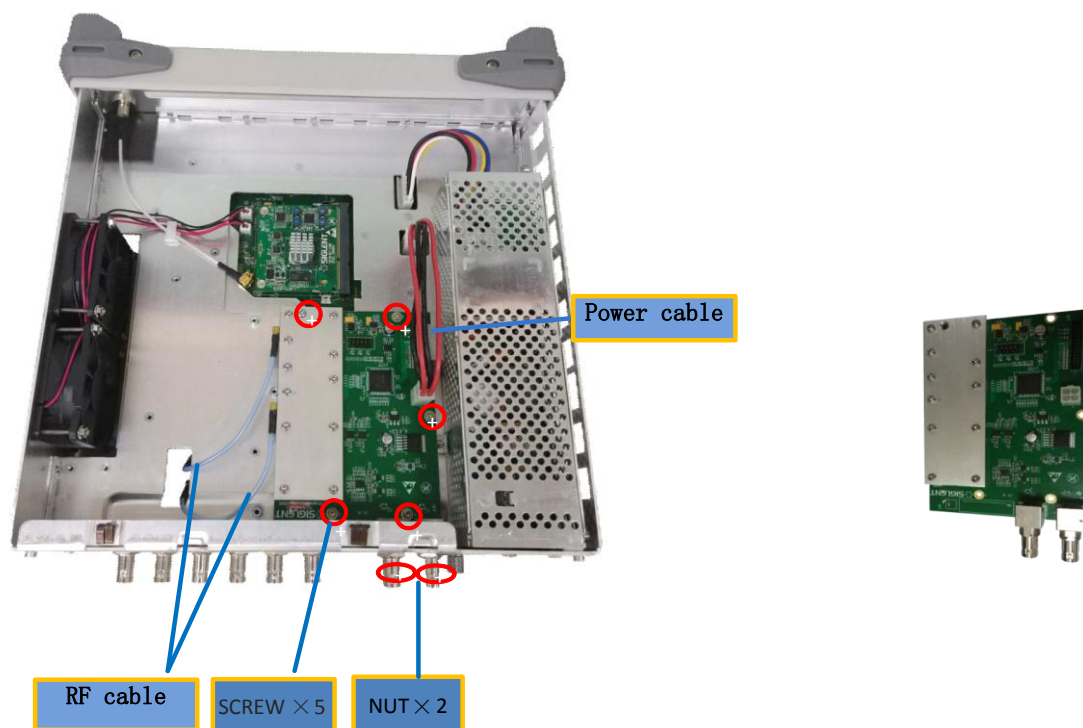

Removal steps:

- 1、.Disconnect the power cable and the RF cable
- 2、 Remove the five screws located on the IQ board.
- 3、 Next, remove the IQ board.

To install the IQ board, please follow these same steps in reverse order.

Removing the Power Module

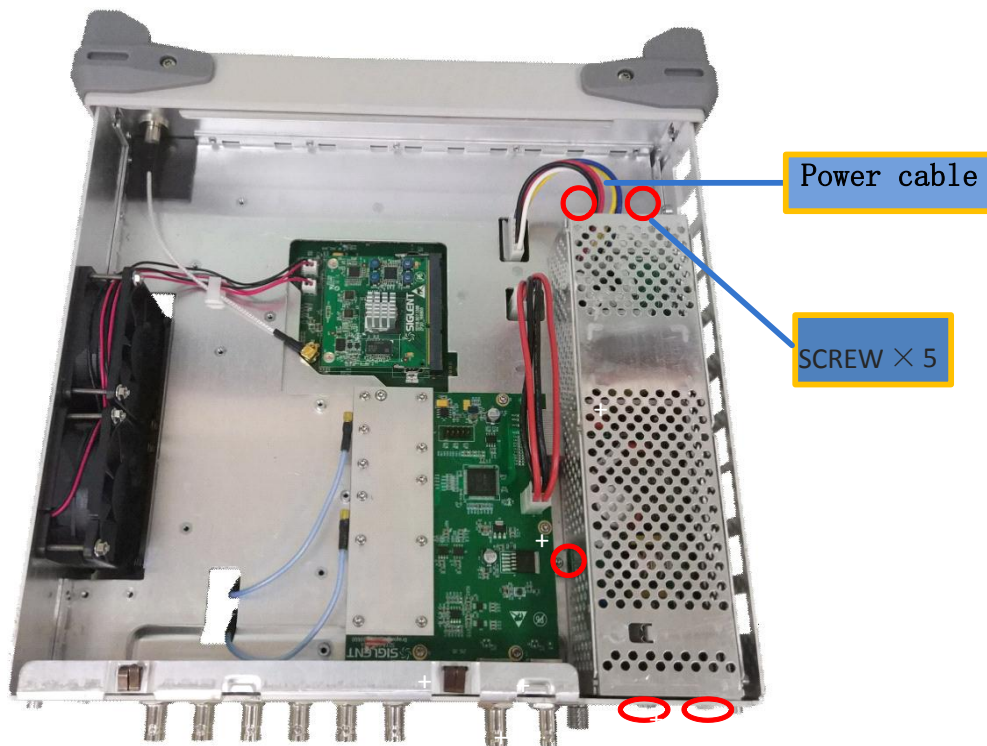

Removal steps:

- 1、 Disconnect the power cable
- 2、 Remove the five screws located on the metal shell
- 3、 Next, remove the Power Module

To install the Power Module, please follow these same steps in reverse order.

Removing the Control Board

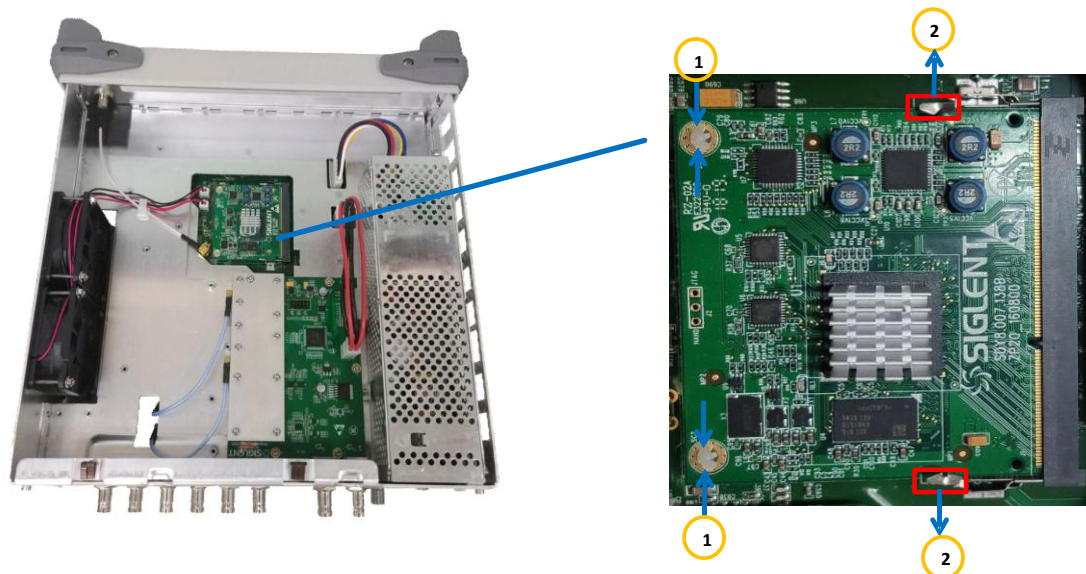

Removal steps:

- 1、 Unlock the hook as show in the above figure
- 2、 Remove the control board

Removing the Main Board

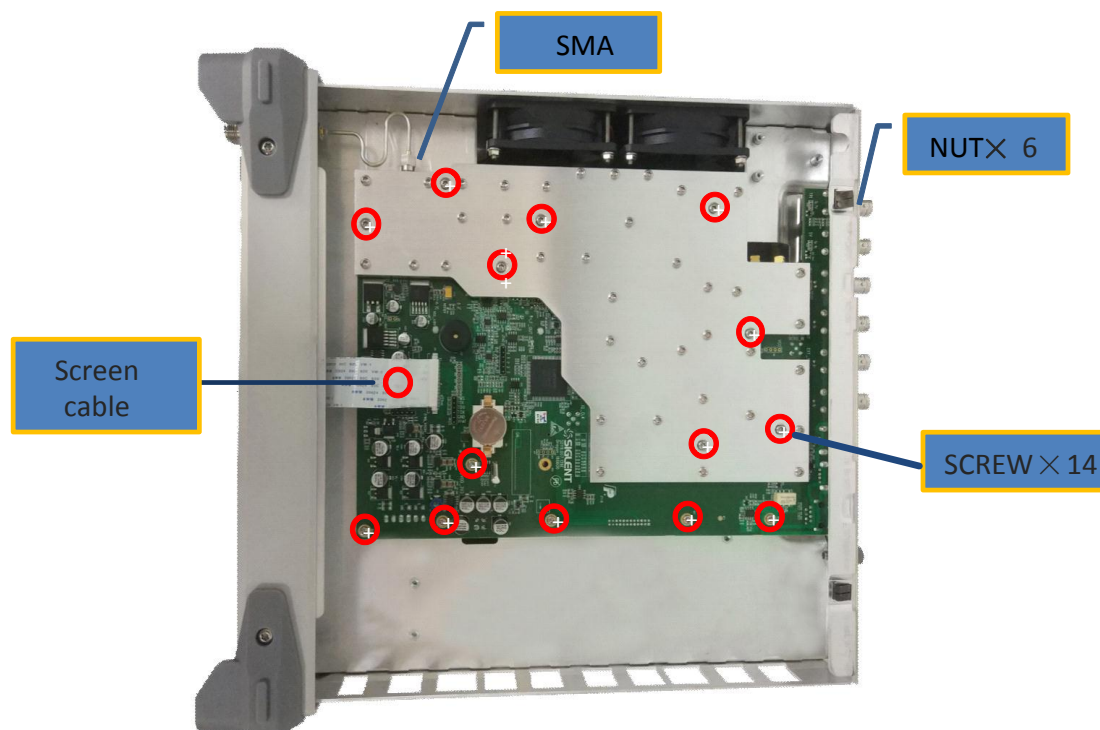

Removal steps:

If the device has the IQ_E option, remove the IQ board first

1. Place the signal generator bottom up.

2. Disconnect the screen cable and RF cable connected to the main board module from the fronted module.
3. Remove the screws located on the main board.
4. Remove the six nuts from the back BNC terminal.

To install Main Board, please perform these steps in reverse order.

Removing the front panel

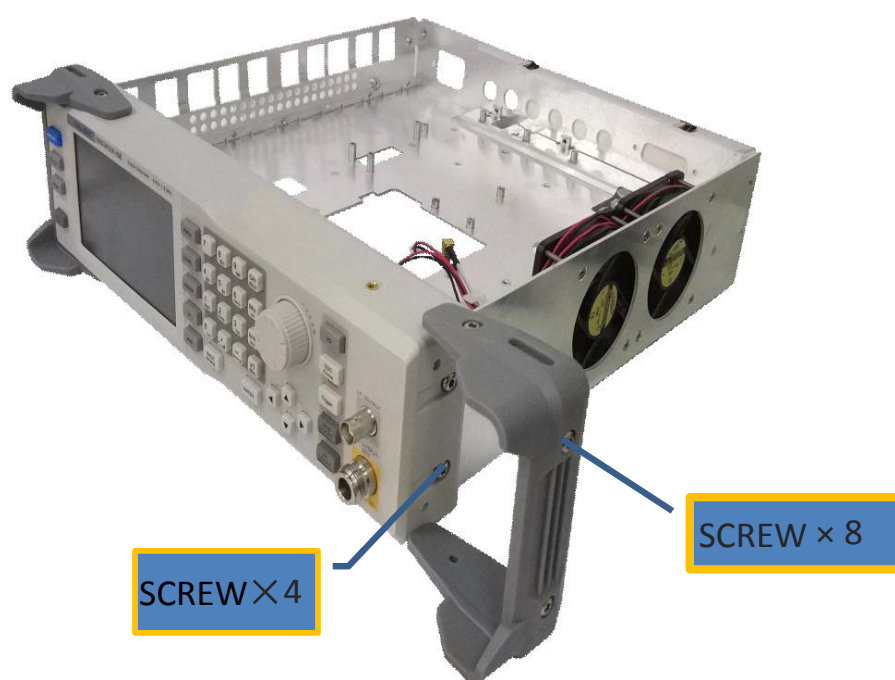

Figure 4-4 View of front panel

Removal steps:

1. Remove the eight screws on the rubber feet
2. Remove the four screws located on the front panel.

To install the front panel, please perform these steps in reverse order.

Removing the LCD, Keyboard

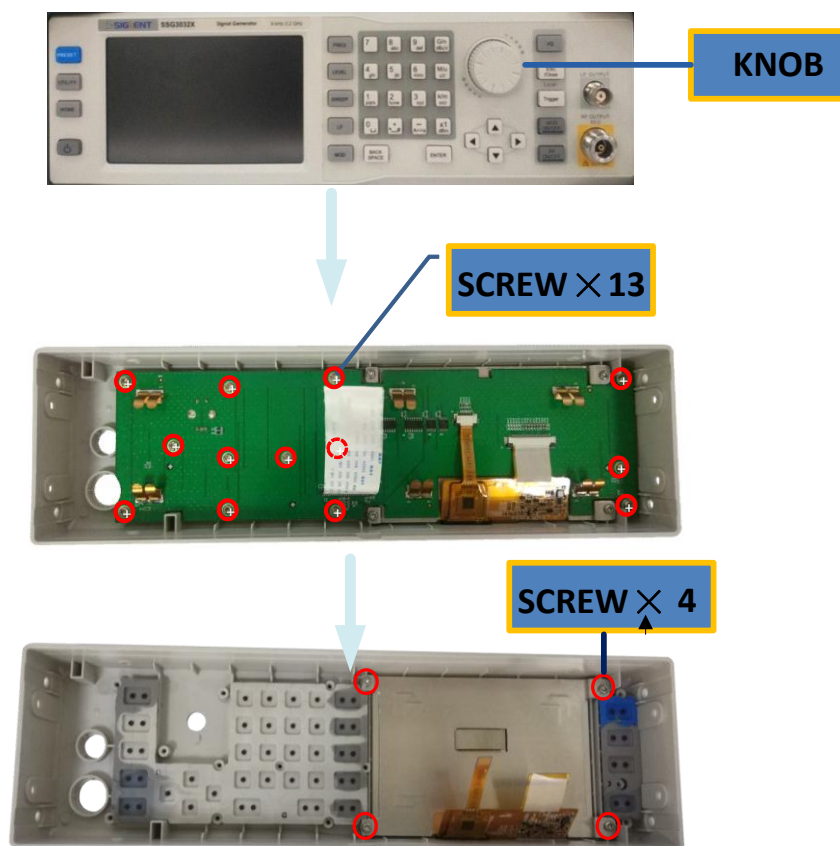

Figure 4-5 Removing the LCD and keyboard

Removal steps:

1. Remove the thirteen screws on the keyboard.
2. Remove the four screws located on the edge of the display module.
3. Disconnect the cable that connects the keyboard and the channel board.
4. Separate the modules carefully.