

SDS2000X Plus Digital Storage Oscilloscope

Quick Start

QS0102XP_E01A



Copyright Information

Declaration

SIGLENT products are protected by patent law in and outside of P.R.C.

SIGLENT reserves the right to modify or change parts of or all the specifications or pricing policies at the company's sole decision.

Information in this publication replaces all previously corresponding material.

Any method of copying, extracting or translating the contents of this manual is not allowed without the permission of SIGLENT.

Note: SIGLENT is the registered trademark of SIGLENT TECHNOLOGIES CO., LTD.

Contents

COPYRIGHT INFORMATION.....	1
GENERAL SAFETY SUMMARY.....	3
GENERAL CARE AND CLEANING.....	5
GENERAL INSPECTION	6
QUICK START.....	7
FRONT OF OSCILLOSCOPE	9
BACK OF OSCILLOSCOPE.....	10
PROBE COMPENSATION.....	11
USER INTERFACE.....	12
BASIC OPERATIONS	19

General Safety Summary

Carefully read the following safety precautions to avoid any personal injury or damage to the instrument and any products connected to it. To avoid potential hazards, please use the instrument as specified.

Use Proper Power Cord

Only the power cord designed for the instrument and authorized by local government regulations should be used.

Ground the Instrument

The instrument is grounded through the protective earth conductor of the power cord. To avoid electric shock, please make certain the instrument is grounded correctly before connecting its input or output terminals.

Connect the Signal Cable Correctly

The potential of the signal cable ground is equal to the earth ground. Do not connect the signal wire to a high voltage.

Look Over All Terminals' Ratings

To avoid fire or electric shock, please look over all ratings and sign instructions of the instrument. Before connecting the instrument, please read the manual carefully to gain more information about the ratings.

Use Proper Overvoltage Protection

Make sure that no overvoltage (such as that caused by a thunderstorm) can reach the product, or else the operator might be exposed to the danger of electrical shock.

Electrostatic Prevention

Operate in an electrostatic-protected area environment to avoid damages induced by static

discharge. Always ground both the internal and external conductors of the cable to release a static charge before connecting.

Maintain Adequate Ventilation

Inadequate ventilation may cause an increase in temperature, which may eventually damage the instrument. Maintain suitable ventilation and inspect the fan and intake regularly.

Avoid Exposed Circuits and Components

Do not touch exposed contacts or components when the instrument's power is on.

Use Only the Specified Fuse

Do Not Operate Without Covers

Do not operate the instrument with covers or panels removed.

Safety Terms and Symbols

Terms used in this product. These terms may appear in the product:

DANGER Indicates direct injury or hazards that may happen.

WARNING Indicates potential injury or hazards that may happen.

CAUTION Indicates potential damage to the instrument or other property that may happen.

Symbols used in this product. These symbols may appear on the product:



Hazardous
Voltage



Protective Earth
Ground



Warning



Earth Ground



Power Switch

General Care and Cleaning

Care

Do not store or leave the instrument in direct sunshine for extended periods of time.

To avoid damages to the instrument or probes, please do not expose them to fog, liquid, or solvents.

Cleaning

Please perform the following steps to clean the instrument and probes regularly in accordance with its operating conditions.

1. Disconnect the instrument from all power sources and then clean with a soft wet cloth.
2. Clean the loose dust on the outside of the instrument and probe with a soft cloth. When cleaning the LCD, take care to avoid scratching it.

To avoid damage to the surface of the instrument and probe, please do not use any corrosive liquid or chemical cleansers.

Make sure that the instrument is completely dry before restarting it to avoid potential short circuits or personal injury.

General Inspection

1. Inspect the shipping container

Keep the damaged shipping container or cushioning material until the contents of the shipment have been completely checked and the instrument has passed both electrical and mechanical tests.

The consigner or carrier will be responsible for damages to the instrument resulting from shipment. SIGLENT would not provide free maintenance or replacement if the instrument has been damaged in shipment.

2. Inspect the instrument

If there are instruments found damaged, defective or failure in electrical and mechanical tests, please contact SIGLENT.

3. Check the accessories

Please check the accessories according to the packing list. If the accessories are incomplete or damaged, please contact your SIGLENT sales representative.

Quick Start

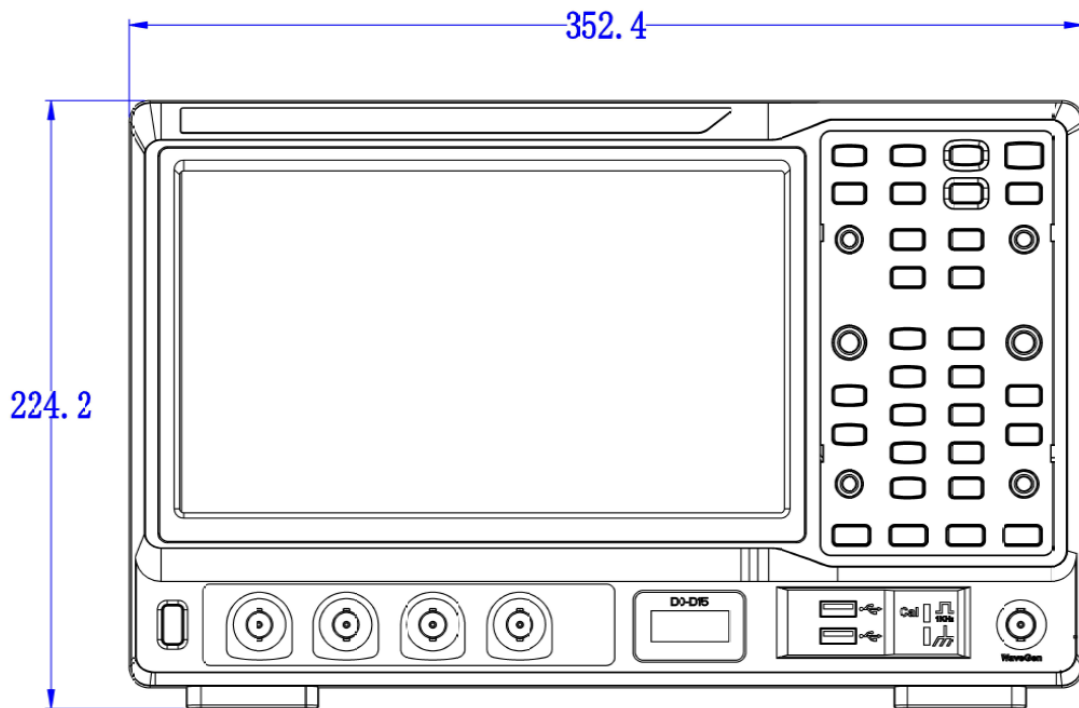

Front View

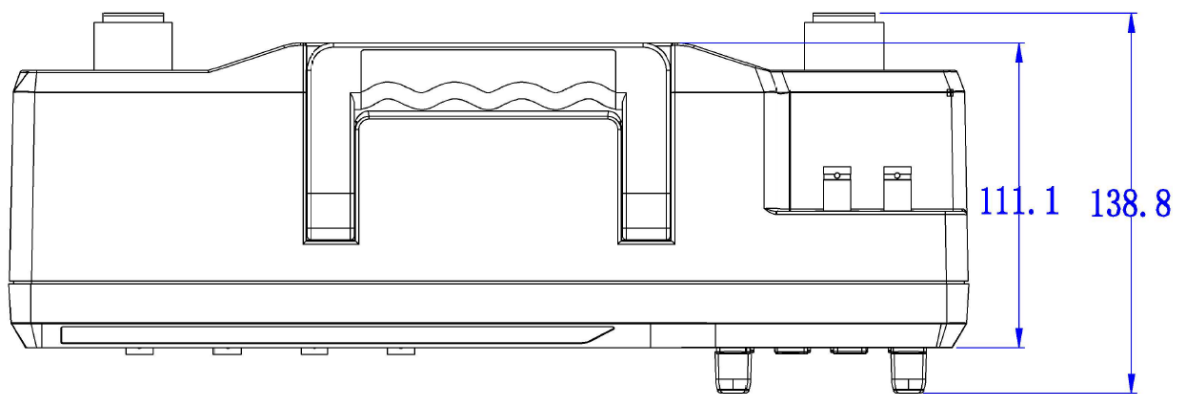

Top View

Adjust the Supporting Legs

Adjust the supporting legs properly to use them as stands to tilt the oscilloscope upwards for stable placement as well as easier operation and observation of the instrument.

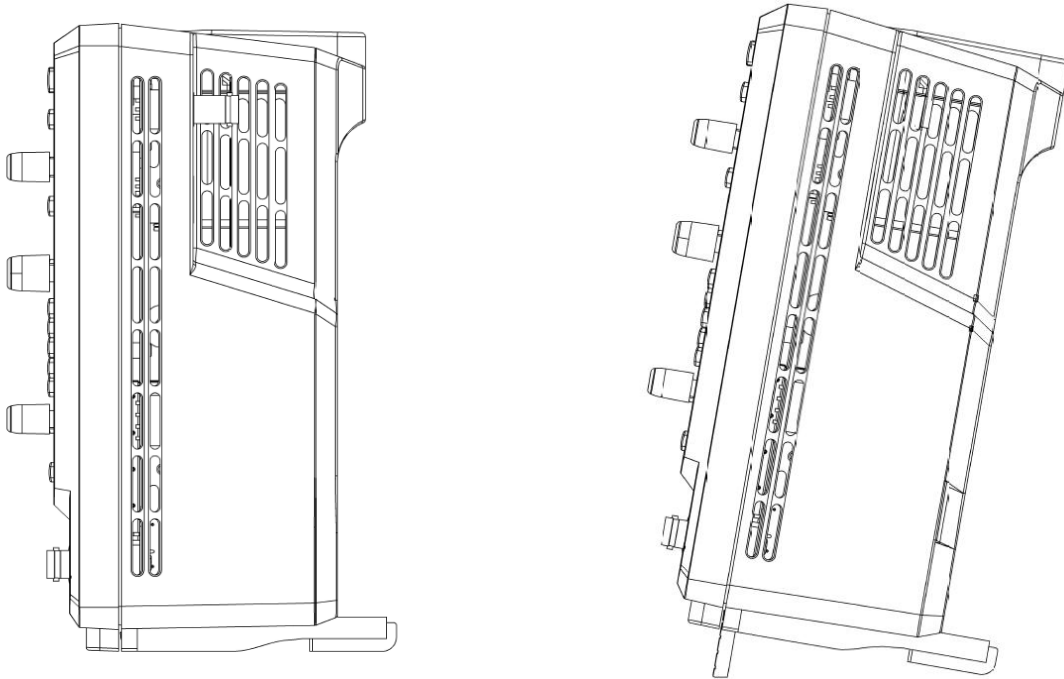

Connecting to Power Supply

The standard power supply for the instrument is 100~240 V, 50/60 Hz or 100~120 V, 400 Hz. Please use the power cord provided with the instrument to connect it to AC power.

Front of Oscilloscope

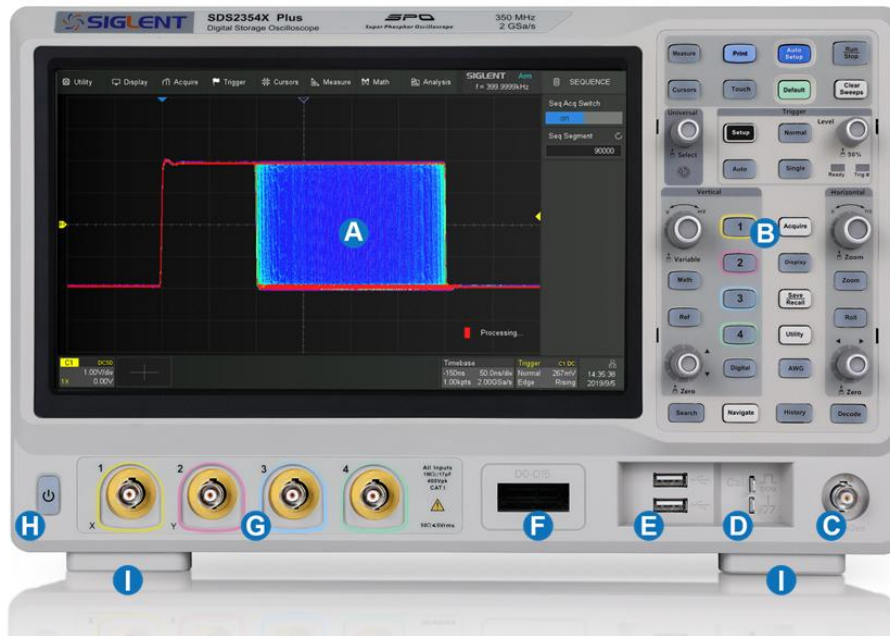

- A** Touch Screen Display **B** Front Panel **C** Waveform Generator Output
- D** Probe Compensation / Ground Terminal **E** USB Host Ports **F** Digital Input Connector
- G** Analog Input Connectors (CH1, CH2, CH3, CH4) **H** Power Switch **I** Supporting Legs

- See the “User Interface” chapter for more details about Touch Screen Display and Front Panel.
- The built-in **Waveform Generator** is capable of outputting up to 50 MHz frequency.
- Connect the USB Host Ports to USB storage devices used for data transfer, or USB mouse / keyboard for control.
- Digital Input Connector** receives 16-channel digital signals from the SPL2016 digital probe.

Back of Oscilloscope



- A** Auxiliary Output outputs the trigger indicator. When Pass / Fail is enabled, outputs the pass / fail signal.
- B** External Trigger Input.
- C** LAN Port connects to the network for remote control.
- D** USB Device connects with a PC for remote control.
- E** AC Power Input.
- F** Handle.

Probe Compensation

All oscilloscope probes should be properly compensated before their first use with the oscilloscope. A non-compensated or inadequately compensated probe may cause inaccurate measurement. The following steps illustrate the proper probe compensation procedure.

1. Use the probe to connect the CH1 Input Terminal and the Compensation Signal Output Terminal **D** on the front panel. Connect the ground alligator clip of the probe to the “Ground Terminal” under the compensation signal output terminal.
2. Check the displayed waveforms and compare them with the following figure.

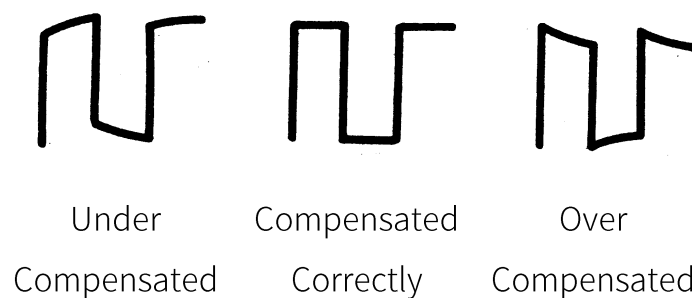

3. Use a nonmetallic flat-head screwdriver to adjust the low-frequency compensation adjustment hole on the probe until the waveform matches the “Compensated Correctly” waveform above.

User Interface



- A** Menu Bar with drop-down menus lets you access set-up dialogs and other functions. All functionality can be accessed through the menu bar.
- B** Grid Area displays the waveform traces. Traces can be moved by dragging them and re-scaled by pinch and spread.
- C** Channel descriptor boxes include analog channels (C1 ~ C4), digital channels (D), math (F1-F2) and reference (Ref). They are located under the grid area, showing the parameters of the corresponding traces. Touching the boxes creates a dialog box.
- D** Timebase and Trigger Descriptor Boxes show the parameters of timebase and trigger respectively. Touching the boxes creates a dialog box.
- E** Dialog Box is the main area to select the parameters for a chosen specific function.
- F** Trigger Delay Indicator locates where the waveform triggers on the horizontal axis.
- G** Trigger Level Indicator shows the level where the waveform triggers on the vertical axis.
- H** Cursors show where measurement points have been set.

Channel Descriptor Box

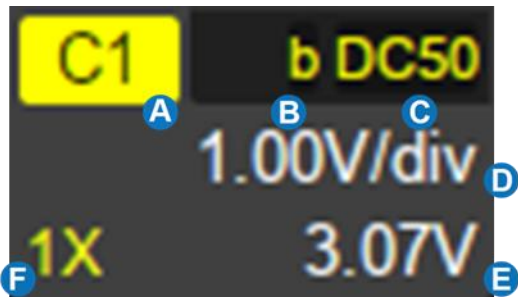

- A** Channel index
- B** Bandwidth limit indicator
- C** Coupling and impedance
- D** Volts/div
- E** Offset
- F** Probe attenuation

Timebase and Trigger Descriptor Boxes

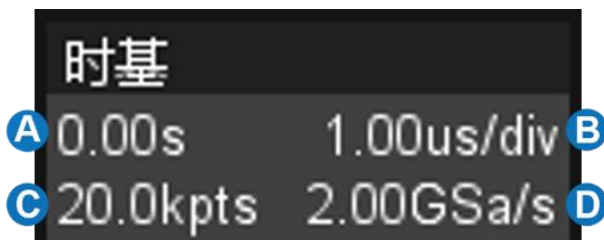

- A** Trigger delay
- B** Time/div
- C** # Samples
- D** Sample rate

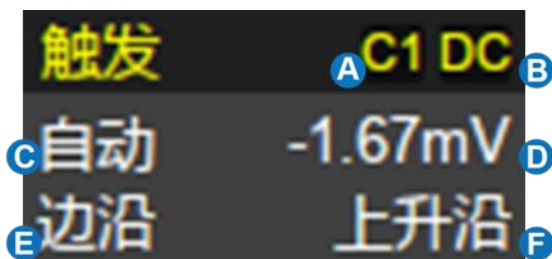

- A** Trigger source
- B** Trigger coupling
- C** Trigger mode
- D** Trigger level
- E** Trigger type
- F** Trigger slope

Dialog Box

The dialog box on the right side of the screen is the main area for setting the parameters of the selected function.

- A** A. Title bar. Touching the bar can hide the dialog box, and touching again can open the dialog box.
- B** Parameter setting area.
- C** Scroll bar. When parameters are more than the displayed range, the blue scrollbar will be displayed. By sliding the dialog area up and down, or rolling the mouse wheel, it can scroll to the area not displayed.

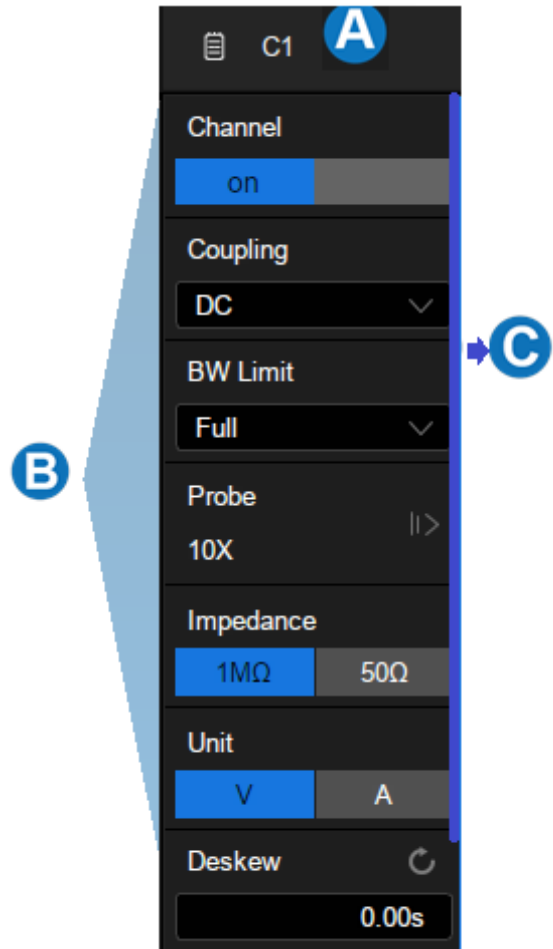

To Set Parameters

The SDS2000X Plus provides several different ways to set parameters:

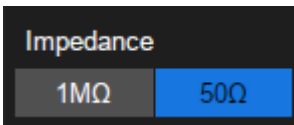

Switch – sets parameters with two states, such as to enable or disable a function. Touch the switch region to change from one state to the other.

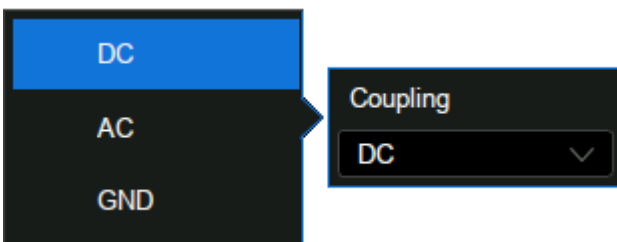

List – sets parameters with more than two options, such as the coupling mode of channels. Touch the parameter region, and then select the expected option from the pop-up list.

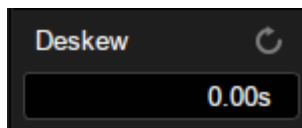

Virtual Keypad – Sets parameters with a numerical value. Touch the parameter region, and the parameter can be adjusted by the universal knob on the front panel; touch the region again, then the virtual keypad appears;

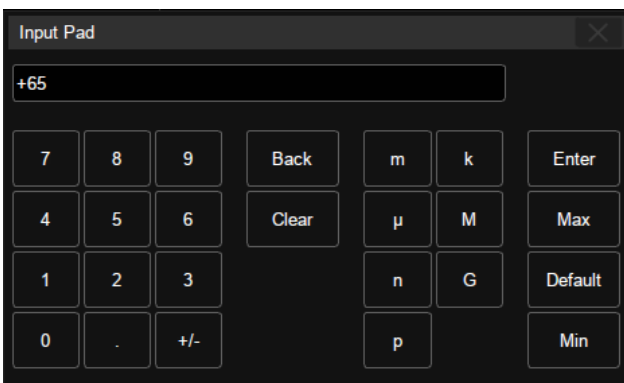

To use the operation of setting “deskew” of the channel as an example: If the expected value is 65 ns, input “65” on the virtual keypad, and then choose the unit **n** to complete the operation. On the virtual keypad, touching the button **Max**, **Min**, and **Default** quickly sets the parameter to its maximum, minimum and default values.

Touch Gestures

Waveforms, cursors and trigger level can be adjusted by touch gestures in the grid area.

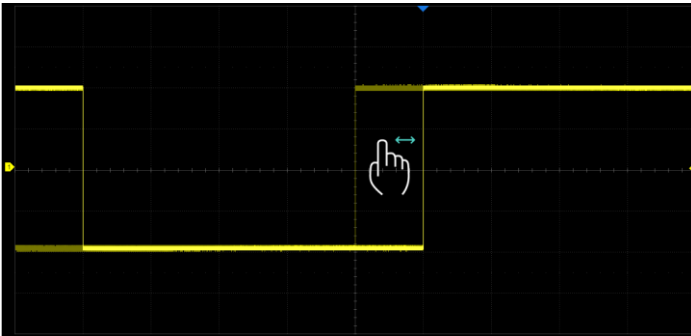

Drag the waveform left and right to move it on the horizontal axis

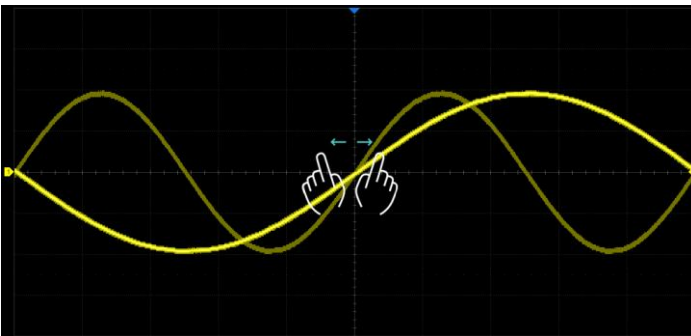

Pinch and spread the waveform horizontally to re-scale the timebase

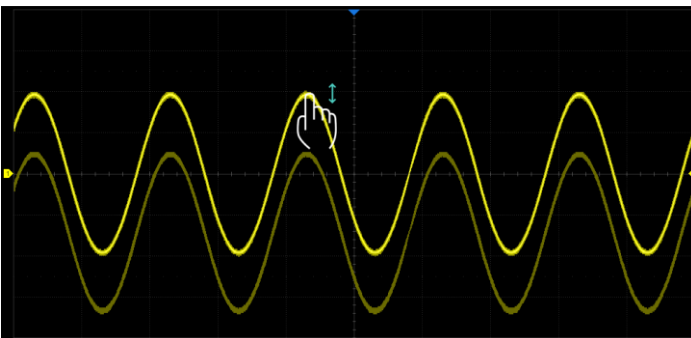

Drag the waveform up and down to move it on the vertical axis

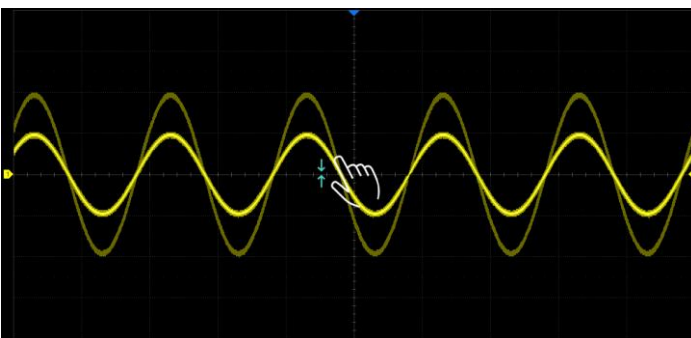

Pinch and spread the waveform vertically to re-scale the vertical gain

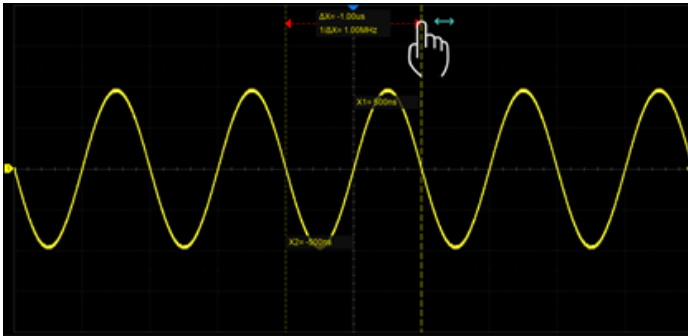

Touch and drag the cursor to move it

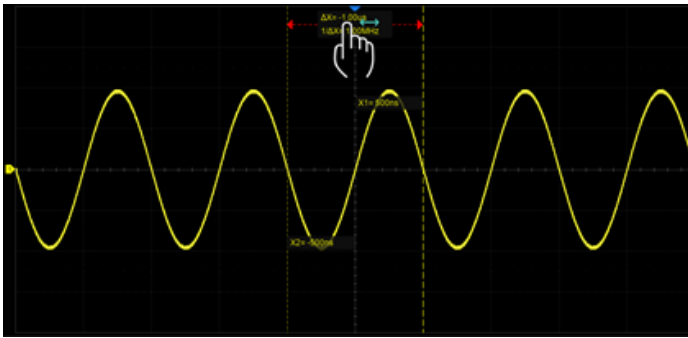

Touch and drag the cursor information region to move the pair of cursors simultaneously

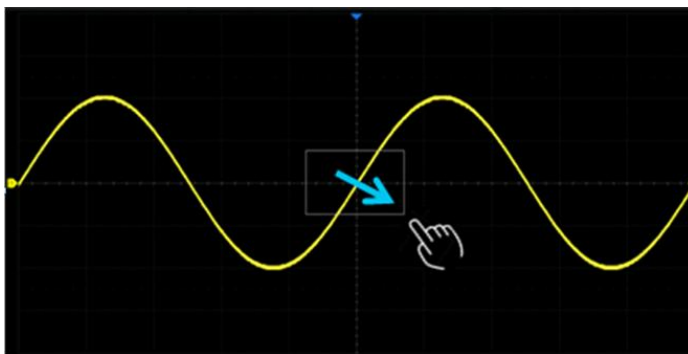

Draw a rectangular box to create a zone or a histogram region. At the beginning of the gesture keep the angle close to 45° so it can be recognized as the drawing box gesture

Front Panel



Most of the front panel controls duplicate functionality available through the touch screen display. They are covered in more detail in the Basics section and in the User Manual.



Automatically sets the waveform to adapt the display according to its frequency and amplitude



Resets the oscilloscope to the default configuration.



Enables or disables the touch screen. When it is lighted the functionality is enabled



Rotate the universal knob to set the value of the activated parameter, or to move the selected cursor. Push to select a different cursor.

Choosing the Language



Basic Operations

Turn On / Disable a Channel

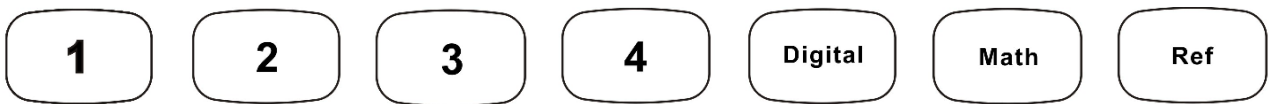

From the Front Panel

Push the channel button (1-4, Digital, Math, Ref) to turn on the corresponding channel. Its channel descriptor box and dialog box will appear on the display.



If a channel is already on but not activated, push the button to activate it. If a channel is already on and activated, push the same button again to disable the channel.

From the Touch Screen

Touch the  button and then select the expected channel to turn it on, and its channel descriptor box and the dialog box will appear on the display. Touch the channel descriptor box and then touch the  button to disable it.

Vertical System

- A** Analog channel on / off
- B** Rotate the knob to adjust the vertical scale (volts/div). Push to switch to alternate between coarse and fine adjustments
- C** Rotate the knob to adjust the DC offset or vertical position of the channel. Push to set the offset to zero
- D** Digital channels on / off
- E** Math on / off
- F** Reference on / off



Channel Setup

Touch the channel descriptor box, a quick dialog will pop up. Vertical scale and offset can also be set from this dialog box.



- A** Touch the region to set the vertical scale with the universal knob or virtual keypad
- B** ▲ to increase the vertical scale and ▼ to decrease
- C** Check to coarsely adjust the vertical scale and uncheck to enable fine adjustment
- D** Touch the region to set the offset with the universal knob or virtual keypad
- E** ▲ to increase the offset and ▼ to decrease
- F** Set the offset to zero
- G** Copy the setting of the current channel to another channel
- H** Quickly select the current channel as the source of a specified operation (Trigger, FFT, Measure, Cursor, Search, DVM, and Counter)
- I** Disable the channel
- J** Open the dialog box on the right side

Activating a channel or touching **J** in the quick dialog of the channel recalls the channel dialog box, displaying more parameters:

- A** Turn channel on/off
- B** Coupling (DC, AC or GND)
- C** Bandwidth limit (Full, 200 MHz or 20 MHz)
- D** Probe attenuation (1X, 10X, 100X or custom)
- E** Set the label text. Click to recall the label setting. Users can customize the text and display of the label
- F** Quickly apply a specified operation (Cursor, Measure, FFT, Search, DVM, Histogram and Mask Test) to the current channel
- G** Impedance
- H** Units for the channel
- I** Deskew
- J** Enable/disable invert

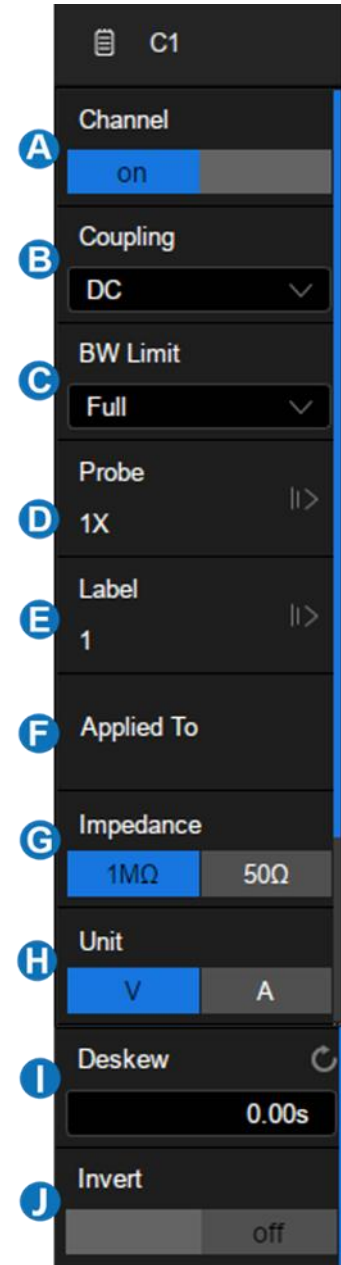

Horizontal System

- A** Rotate to adjust the horizontal scale (time/div); When Zoom is enabled, push to switch between the main window and zoom window
- B** Rotate to adjust trigger delay; push to set trigger delay to zero
- C** Push to enable Zoom mode; Push again to exit Zoom
- D** Push to enable horizontal Roll; push again to exit Roll mode. At timebase settings larger than 50ms/div, it is recommended to set the oscilloscope to Roll mode so that the waveform is displayed in real-time

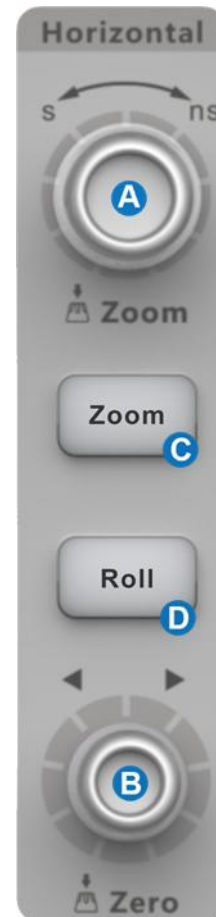

Touch the timebase descriptor box to display a quick dialog box. Timebase and Trigger Delay can also be set in this dialog box.

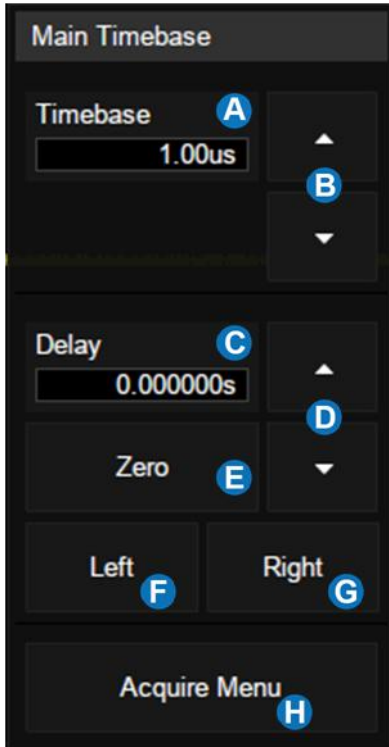

- A** Set the horizontal scale (timebase) by the virtual keypad
- B** ▲ to increase and ▼ to decrease the horizontal scale
- C** Set the trigger delay by the virtual keypad
- D** ▲ to increase and ▼ to decrease the trigger delay
- E** Set the trigger delay to zero
- F** Set the trigger delay to the left part of the screen
- G** Set the trigger delay to the right part of the screen
- H** Open the Acquire dialog box

Acquisition System

Touch **H** on the quick menu of the timebase settings, or press the **Acquire** button on the front panel, or touch the menu bar **Acquire** > **Menu** to recall the Acquire dialog box on the right side.

- A** Select the interpolation mode
- B** Select the Acq mode
- C** Select the acquisition mode (Normal/Peak)
- D** Select the maximum memory depth (up to 200 Mpts/ch)
- E** Set Sequence mode
- F** Select the vertical resolution. When 10-bit is selected, the resolution is enhanced by 4 times, while the bandwidth is downgraded to around 100 MHz

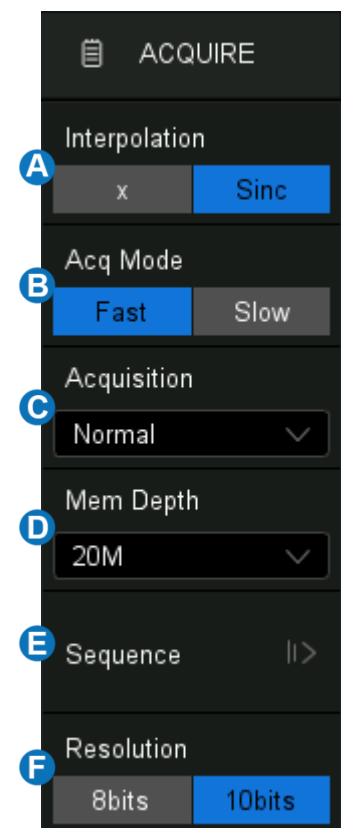

Zoom

The SDS2000X Plus supports waveform zoom in the horizontal and vertical directions. Push the **Zoom** button on the front panel to enable Zoom mode.



When the Zoom mode is enabled, Press down the horizontal knob to switch between the main window and zoom window.

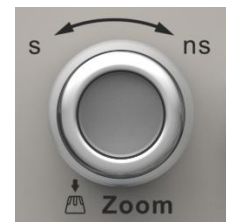

In Zoom mode the grid area is divided into two areas. The main window appears on the top and the zoom window on the bottom. The region without the gray background in the main window is the portion of trace that is magnified in the zoom window. Please refer to the User Manual for detailed operation instructions of Zoom mode.

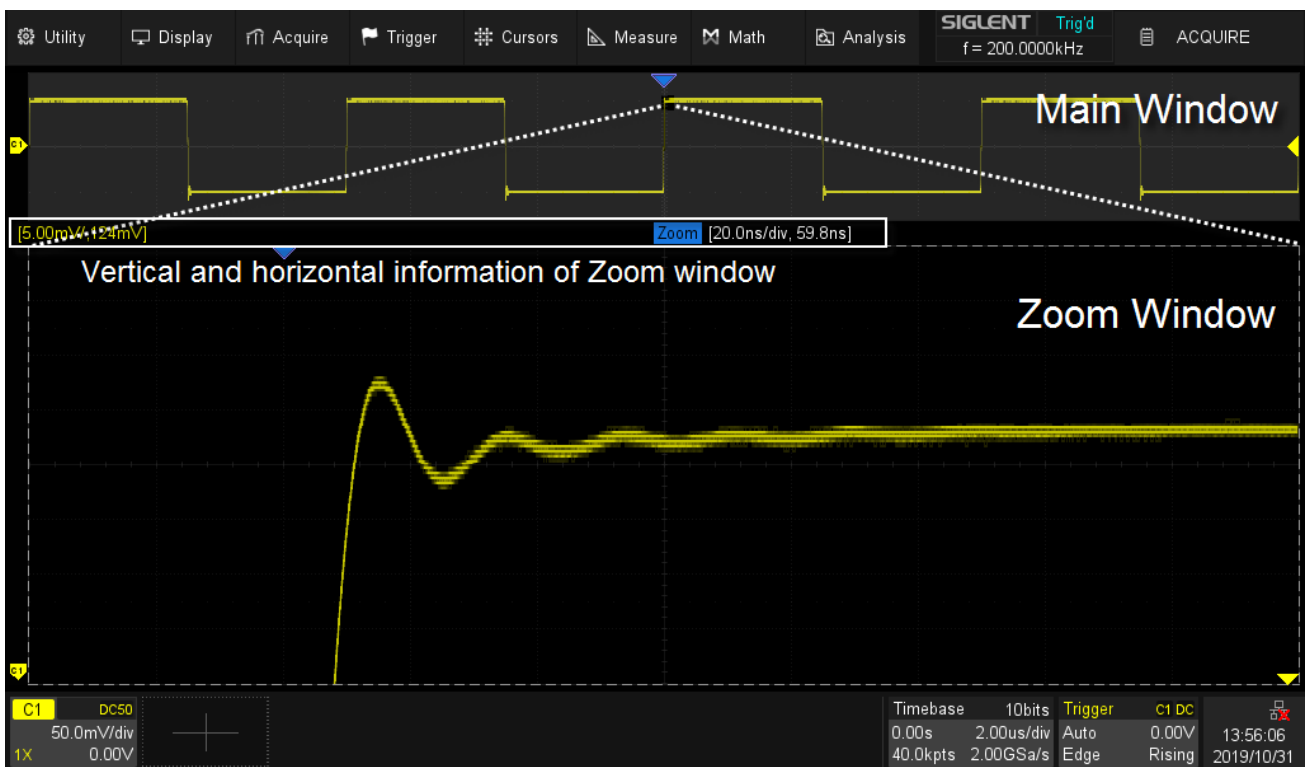

Trigger

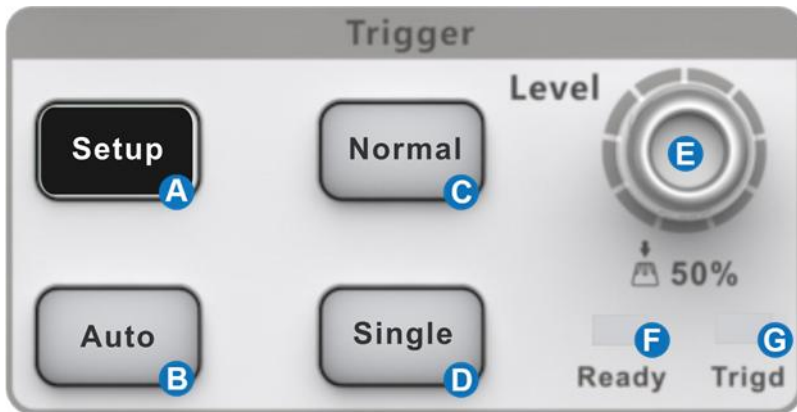

The trigger system supports multiple powerful triggering modes including serial bus triggering. Refer to the User Manual for more details.

- A** Opens trigger setup dialog box
- B** Auto mode – triggers after preset period if no valid trigger occurs
- C** Normal mode – triggers repeatedly when all conditions are met
- D** Single-mode – triggers once when all conditions are met
- E** Trigger level adjustment -- push to set the level to 50% of the waveform
- F** Ready LED, lighted when ready for trigger
- G** Trig'd LED, lighted when a trigger event happens

Indicators Relative to Trigger

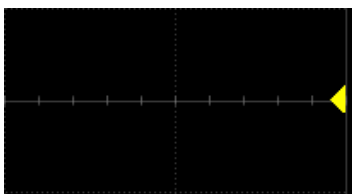

Trigger level indicator

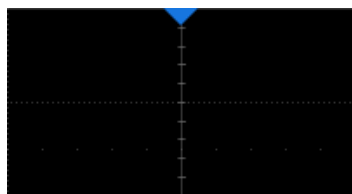

Trigger delay indicator



Trigger delay indicator
(outside the screen)

- A** Select trigger type
- B** Select the trigger source
- C** Select the trigger slope (When the trigger type is "Edge", "Slope" and other specific types)
- D** Set holdoff (None/Time/Events)
- E** Set trigger coupling mode (DC/AC/LF Reject/HF Reject)
- F** Enable/disable Noise Rejection. When Noise Reject is on, the trigger hysteresis is increased, so the noise immunity of the trigger circuit is better. As a compromise, the trigger sensitivity degrades
- G** Set the Zone trigger

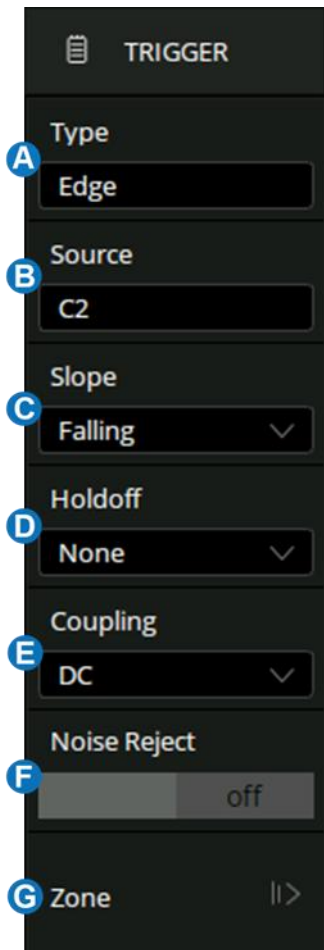

Math

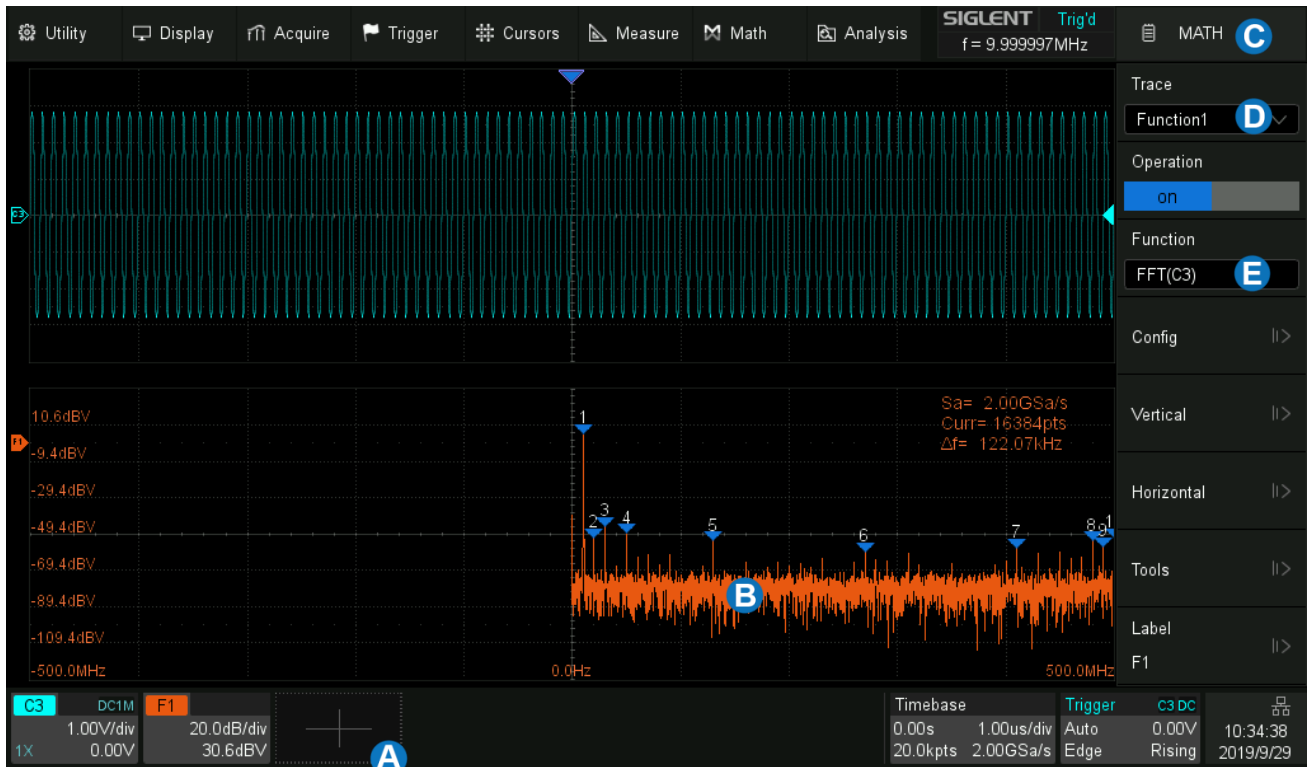

- A** Touch **+** > **Func1/Func2**, or push the **Math** button on the front panel to create a math trace and open math setup dialog box **C**
- B** Math trace
- C** Math setup dialog box
- D** Selects the trace (F1 or F2)
- E** Selects the operator and source (C1~C4, Z1~Z4, F1~F2)

Measure & Statistics

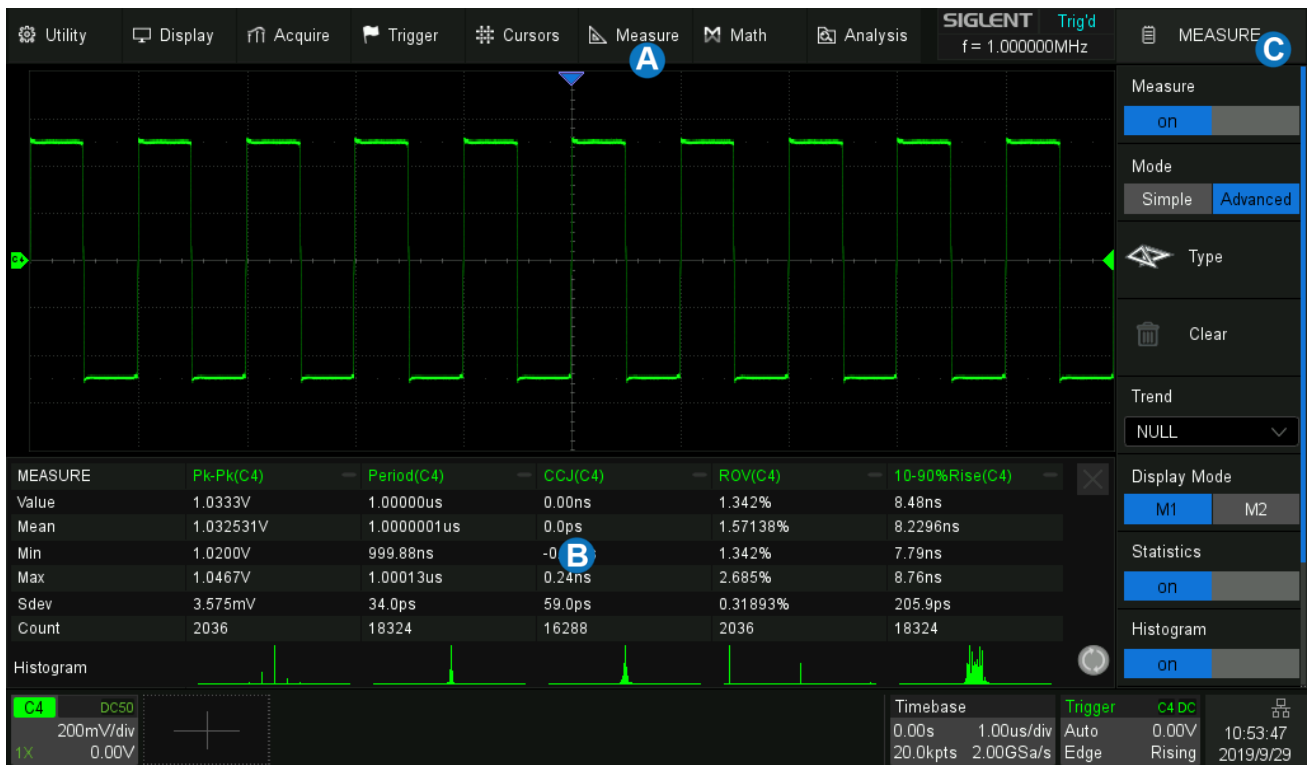

- A Touch **Measure** > **Menu**, or push the **Measure** button on the front panel to open measure setup dialog box
- B Measurement parameters and statistics display area. If select the mode as “Simple”, the "Simple" parameter area is displayed. Touch the **Clear Sweeps** button on the front panel to reset the statistics
- C Measure dialog box

Cursors

Cursors set measurement points on the Vertical or Horizontal axis of a trace (or both). For more information please refer to the User Manual.



- A** Push the button to open the cursors setup dialog box
- B** Rotate the knob to move the selected cursor; push to select different cursor

The display mode of cursors

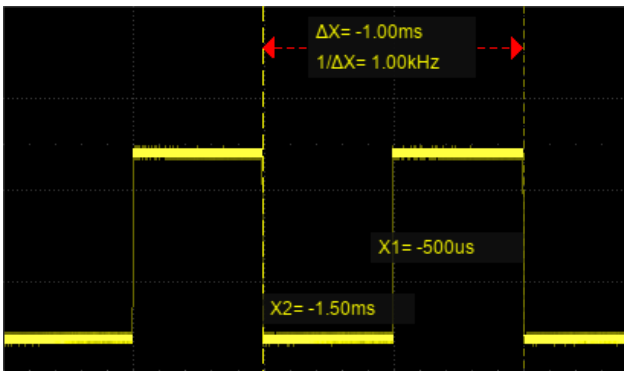

Display mode 1



Display mode 2

Reference Waveforms

Reference waveforms (REFA, REFB, REFC, and REFD) are analog or math traces stored in the non-volatile memory. They can be recalled to the display for comparison with other traces.

Press the  button on the front panel to set the reference waveforms.

- A** Select the location of the reference (REFA/REFB/REFC/REFD)
- B** Select the source (C1~C4, F1~F2)
- C** Enable/disable Display of the reference waveform
- D** Set the label text of the reference trace
- E** Save the specified waveform in **B** to the specified location in **A**



The reference waveforms (.ref) can be saved to an external storage device. See the chapter “Save / Recall” for details.

Save/Recall

Press the  button on the front panel, or touch **Utility** > **Save/Recall** to save / recall a setup, picture, waveform data or reference waveform.

- A** Choose Save or Recall operation
- B** Select the object type
- C** Specify the location of the object
- D** When the location in **C** is “External” , touch this region to recall the file manager for further operations

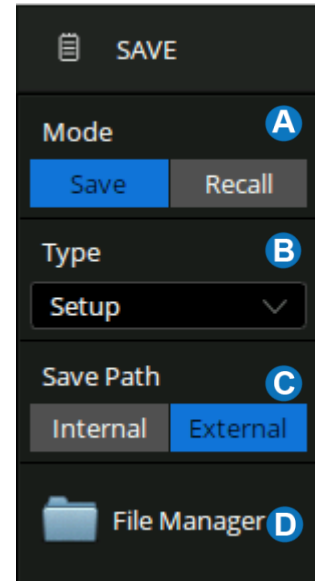

Quickly Save a Screenshot

Push the  button on the front panel to save the screenshot as a picture (.bmp/.png/.jpg) to an external storage device.

Calibration

The oscilloscope is calibrated at the factory prior to being shipped. The calibration is run at 23 °C (± 2 °C) and is valid for temperatures 23 ± 5 °C. Within this temperature range, the oscilloscope will meet all specifications once warmed up.

Warm up the oscilloscope for at least 20 minutes prior to each use or calibration in order for it to reach a stable operating temperature. Specifications are not guaranteed during the warm-up period.

Whenever the oscilloscope is used in an environment outside 23 ± 5 °C, or when it has been more than one month since the previous calibration, manual calibration is recommended. To perform a self-calibration:

Touch **Utility** > **Menu** > **Do Self Cal**

or **Utility** > **Do Self Cal**

Software Option

Installing a Software Option

Follow the steps below to install a software option (see the datasheet for details) after purchasing it and obtaining the Option Key:

1. Utility > Menu > Options , 或 Utility > Options
2. Select the correct Option Type
3. Input the option key in the text box
4. Touch Install and then restart the oscilloscope

About SIGLENT

SIGLENT is an international high-tech company, concentrating on R&D, sales, production and services of electronic test & measurement instruments.

SIGLENT first began developing digital oscilloscopes independently in 2002. After more than a decade of continuous development, SIGLENT has extended its product line to include digital oscilloscopes, function/arbitrary waveform generators, RF generators, digital multimeters, DC power supplies, spectrum analyzers, vector network analyzers, isolated handheld oscilloscopes, electronic load and other general purpose test instrumentation. Since its first oscilloscope, the ADS7000 series, was launched in 2005, SIGLENT has become the fastest growing manufacturer of digital oscilloscopes. We firmly believe that today SIGLENT is the best value in electronic test & measurement.

Headquarters:

SIGLENT Technologies Co., Ltd
Add: Bldg No.4 & No.5, Antongda Industrial
Zone, 3rd Liuxian Road, Bao'an District,
Shenzhen, 518101, China
Tel: + 86 755 3688 7876
Fax: + 86 755 3359 1582
Email: sales@siglent.com
Website: int.siglent.com

USA:

SIGLENT Technologies America, Inc
6557 Cochran Rd Solon, Ohio 44139
Tel: 440-398-5800
Toll Free: 877-515-5551
Fax: 440-399-1211
Email: info@siglent.com
Website: www.siglentna.com

Europe:

SIGLENT Technologies Germany GmbH
Add: Liebigstrasse 2-20, Gebaeude 14,
22113 Hamburg Germany
Tel: +49(0)-819-95946
Fax: +49(0)-819-95947
Email: info-eu@siglent.com
Website: www.siglenteu.com

Follow us on
Facebook: SiglentTech

