

# SPD4000X Series Programmable Linear DC Power Supply



QuickStart

EN01A



SIGLENT TECHNOLOGIES CO.,LTD



# Copyright and Statement

## Copyright

**SIGLENT TECHNOLOGIES CO., LTD.** All rights reserved.

## Trademark Information

**SIGLENT** is registered trademark of **SIGLENT TECHNOLOGIES CO., LTD.**

## Statement

**SIGLENT** products are protected by patent laws in and outside of the P.R. China.

**SIGLENT** reserves the rights to change the specification and price.

Information in this publication replaces all previous corresponding published material.

Contents in this manual are not allowed to be copied, extracted or translated in any form or by any means without **SIGLENT**'s permission.

## Product Certification

**SIGLENT** certified that this product meets China's national product standards and industry product standards, and further certified that this product meets the relevant standards of other international standards organization members.

## Contact Us

**SIGLENT TECHNOLOGIES CO., LTD.**

Address: Blog No.4 & No.5, Antongda Industrial Zone, 3rd Liuxian Road,  
Bao'an District, Shenzhen, 518101, China.

Tel: 400-878-0807

E-mail: support@siglent.com

Http://www.siglent.com

# Contents

Copyright and Statement .....	1
General Safety Summary .....	3
Safety Terms and Symbols .....	4
General Care and Cleaning .....	5
General Inspection .....	5
Considerations.....	6
Mechanical Dimensions.....	7
Preparation Before Use .....	8
Panel Introduction.....	9
User Interface .....	11
Basic Operation .....	13
Remote Control .....	20
More Information .....	20

## General Safety Summary

Please review the following safety precautions carefully to avoid personal injury or damage to this product or any product connected to it. To prevent potential danger, please use the instrument as specified.

### Use proper power cord

Only the power cord designed for the instrument and authorized by local country could be used.

### Power supply

AC Input Voltages: 100V/120V/220V/230V±10%, 50/60Hz.

### Use proper fuse

The fuse type of SPD4323X: 100V/120V: T6.3A/250V; 220V/230V: T3.15A/250V.

The fuse type of SPD4121X: 100V/120V: T10A/250V; 220V/230V: T3.15A/250V.

The fuse type of SPD4306X: 100V/120V: T10A/250V; 220V/230V: T6.3A/250V.

Make sure to use the correct type of fuse before turning on the instrument.

Do not connect the power cord before replacing the fuse.

Find out the reason why the fuse burned out before replacing the fuse.

### Ground the instrument

The instrument is grounded through the protective earth conductor of the power cord. To avoid electric shock, the grounding conductor must be connected to the earth. Make sure that the instrument is properly grounded before any inputs or outputs.

### Observe all terminal ratings

To avoid fire or electric shock, please observe all ratings and symbols on the instrument. Read this guide carefully to know more details about the ratings before connection.

### Keep proper ventilation

Inadequate ventilation may cause an increase of temperature, which will lead to further damage. Please keep proper ventilation and check the fan and air-vents regularly when using the instrument.

### Do not operate when you suspect that the product is malfunctioning

If you suspect that this product is damaged, please have it inspected by qualified maintenance personnel.

## Operate condition

Location: indoor, no strong light, almost no Interfering pollution

Comparative humidity:  $\leq 80\%$

Altitude:  $\leq 2000\text{m}$

Temperature:  $0^{\circ}\text{C}$  to  $40^{\circ}\text{C}$

## Do not operate in an explosive atmosphere

To avoid personal injury or damage to instrument, please do not operate in an explosive atmosphere.

## Keep surface of the product clean and dry

To avoid dust or moisture in the air influence the performance of the instrument, please keep surface of the product clean and dry.

## Safety Terms and Symbols

### Terms may appear on the product:

- DANGER** Indicates direct injury or hazard that may happen.
- WARNING** Indicates potential injury or hazard that may happen.
- CAUTION** Indicates potential damage to the instrument or other property that may happen.

### Symbols may appear on the product:



Hazardous  
Voltage



Warning



Protective  
Earth Ground



Earth  
Ground



Power  
Switch

## General Care and Cleaning

### Care:

Do not store or leave the instrument in direct sunshine for extended periods.

### Cleaning:

Please perform the following steps to clean the instrument and joints.

1. Clean the loose dust on the outside of the instrument and joints with a soft cloth.
2. Disconnect the instrument from all power sources and then clean it with a soft damp cloth. For more thorough cleaning, a 75% isopropanol water solvent can be used.

To avoid damage to the surface of the instrument and joints, please do not use any corrosive liquid or chemical cleansers.

Make sure that the instrument is completely dry before restarting it to avoid potential short circuits or personal injury.

## General Inspection

Please check the instrument according to the following steps.

- **Inspect the shipping container**

Keep the damaged shipping container or cushioning material until the contents of the shipment have been completely checked and the instrument has passed both electrical and mechanical tests.

The consigner or carrier will be responsible for damages to the instrument resulting from shipment.

**SIGLENT** would not provide free maintenance or replacement.

- **Inspect the instrument**

If there are instruments found damaged, defective or have failed any electrical and/or mechanical tests, please contact **SIGLENT**.

- **Check the accessories**

Please check the accessories according to the packing list. If the accessories are incomplete or damaged, please contact your **SIGLENT** sales representative.

## Considerations

To ensure that the instrument can work normally, please conduct necessary inspection before using it.

### Input Power Requirement

The SPD4000X allows a 50Hz/60Hz frequency, and four levels of AC power: 100V/120V/220V/230V  $\pm$  10%. You can select wanted power voltage with the "DIP Switch" at the rear panel according to the actual demand.

**Warning**

To switch to the wanted power voltage, please disconnect the power cord first.

### Electrical Check

Please use the power cord provided as accessory and connects the instrument to AC power. Check the power as the following steps.

1. Connect the power supply

**Warning**

To avoid electric shock, please make sure that the instrument is grounded correctly.

2. Turn on the power switch

Turn on the power switch to enter boot interface, and system return to the default settings after a while.



# Mechanical Dimensions

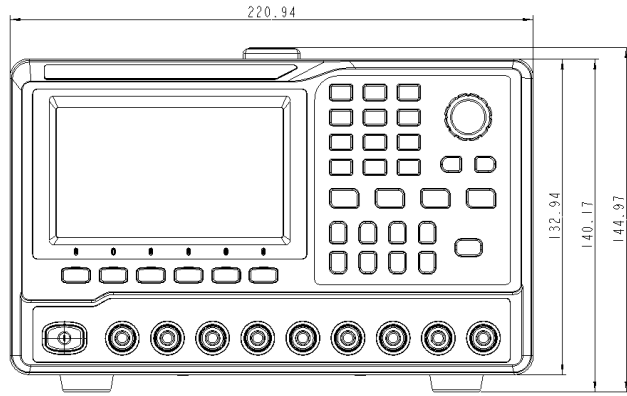

Front View

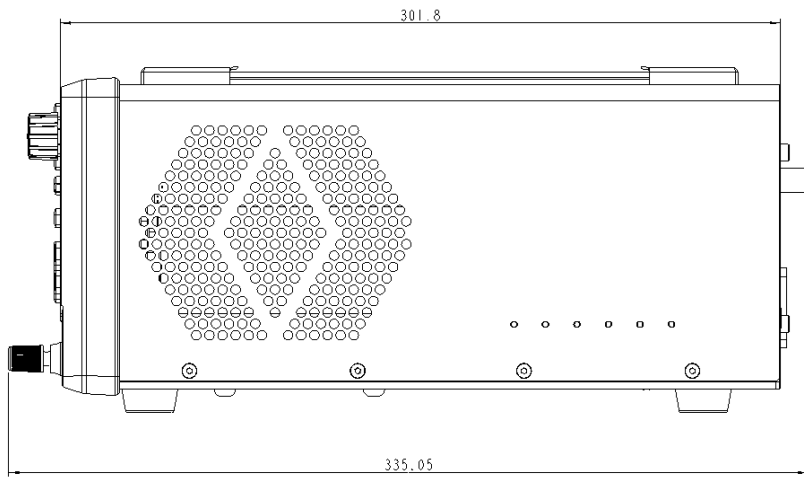

Right View (SPD4323X)

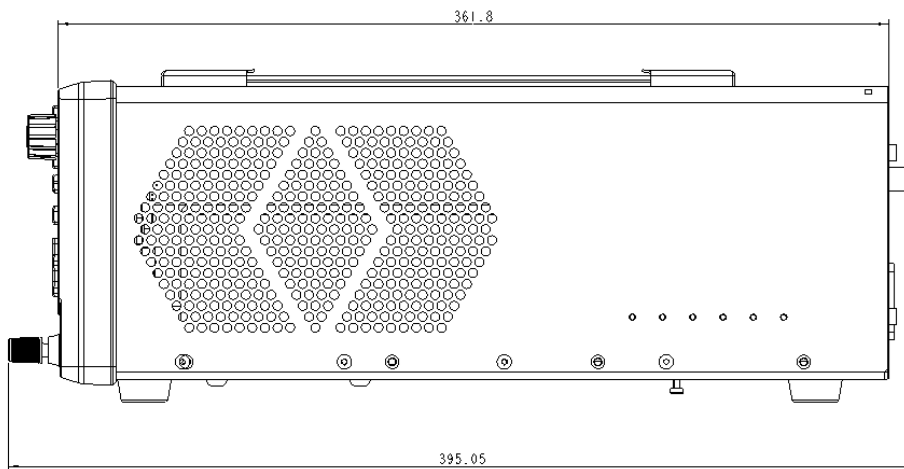

Right View (SPD4121X/SPD4306X)

## Preparation Before Use

### Connect AC Power

The SPD4000X allows a 50Hz/60Hz frequency, and four levels of AC power: 100V/120V/220V/230V $\pm$ 10%. Please use the power cord provided as accessory and connects the instrument to AC power. Before powering on, please confirm that the fuse is working properly.

### Output Check

The output check includes voltage check in condition of all channels with no load and current check in condition of short circuit so as to make sure that the instrument correctly responds to operation of the front panel.

#### Voltage output check:

1. Within no load, turn on the power, and make sure the setting current values of all channels are not zero.
2. Turn on CH1/CH2/CH3/CH4 and the instrument work in constant voltage mode. Check whether the voltage value could be changed from 0V to rated output voltage.

#### Current output check:

1. Turn on the power, and make sure the setting voltage values of all channels are not zero.
2. Use an insulated wire to connect the positive and negative terminal of CH1/CH2/CH3/CH4.
3. Turn on CH1/CH2/CH3/CH4 and the instrument work in constant current mode. Check whether the current value could be changed from 0A to rated output current.

# Panel Introduction



## Front Panel

1. Display area
2. Menu buttons. Access the display interface menu
3. Numeric keypad. Enter a value and press  to confirm
4. Knob. Press the knob can quickly move the cursor position, rotate the knob can increase or decrease the value
5. Right/left direction button. Press the button to move the cursor around
6. Shortcut function buttons
7. Channel control buttons
8. CH1 output terminals
9. CH2 output terminals
10. CH3 output terminals
11. CH4 output terminals
12. Ground terminal
13. Power switch



## Rear Panel

1. Warning message
2. LAN port
3. Ground port
4. USB ports
5. CH2/3 sense port
6. The DIP switch of the AC power and its identification
7. AC power socket and AC input voltage description
8. Fan vents
9. Certification mark
10. Device lock

## **Shortcut Function Buttons**

**Home** : Press this button to directly return to the main interface.

**Parallel/Series** : Set CH2/3 to parallel/series mode. The parallel or series logo of the corresponding mode is displayed on the display area at the same time.

**Save/Recall** : Perform save/recall operations on internal storage or external U disk. When pressing and holding this button for more than 3 seconds, the device will take a screenshot and save it to the U disk connected to the device.

**Lock/Unlock** : Enable/disable the lock function. Short press the button to enable lock function, long press to disable it, and the device will be automatically locked when remotely controlled.

## **Channel Control Buttons**

**1** : Press the button to select CH1 as the current channel.

**2** : Press the button to select CH2 as the current channel.

**3** : Press the button to select CH3 as the current channel.

**4** : Press the button to select CH4 as the current channel.

**On** : Press the button to turn on/off the output of current channel. When this button is illuminated, it indicates that the channel is in an open state.

**All On/Off** : Press the button to turn on/off all the channels. When this button is illuminated, it indicates that all channels are in an open state.

# User Interface

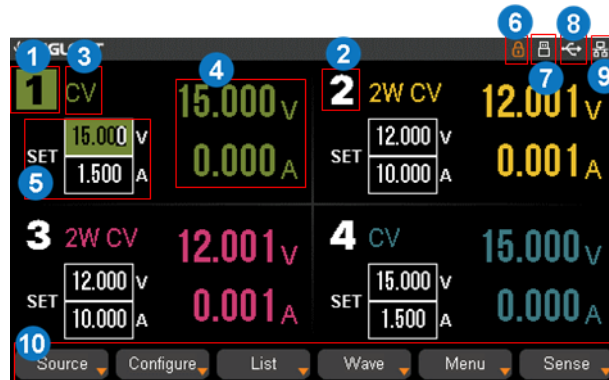

1. Channel logo.
2. CH2/CH3 working state: 2W or 4W.
3. Operating mode logo. The corresponding logo will display when working in CV or CC mode.
4. Output value. Display the current actual output voltage and current.
5. Output settings. Display the current output voltage and current settings, which can be adjusted using the numeric keypad or turning the knob on the front of the panel.
6. Lock logo. It will display when the instrument is currently locked.
7. U disk logo. It will display when there is a U-disk connection.
8. USB logo. It will display when there is a USB connection.
9. LAN logo. It will display when there is a LAN connection.
10. Front panel menu. Contains Source, Configure, List, Wave, Menu, and Sense.

## Source

Press **Source** corresponding menu button on the panel to enter the source setting interface, where you can set the output voltage, output current, overvoltage protection (OVP), overcurrent protection (OCP), etc.

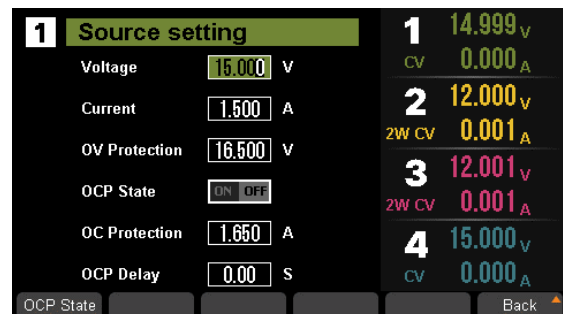

## Configure

Press **Configure** corresponding menu button on the panel to enter the configure setting interface. The following functions can be set:

- Delays: Set the delay time for turning on/off the output. 0-3600s can be set with a resolution of 0.01s
- Operation mode: Set CH2/3 to independent/parallel/series mode
- Default delay: Set the delay time to zero after confirming the setting in the pop-up window
- List coupling

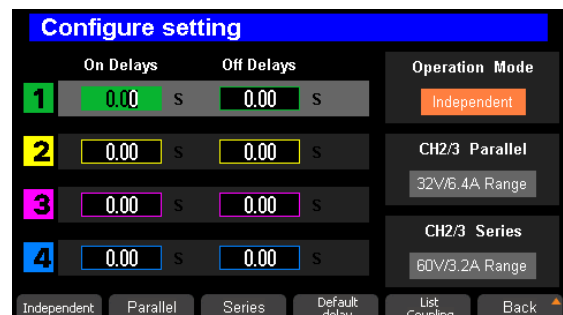

## List

Press **List** corresponding menu button on the panel to enter the list setting interface and set the list.

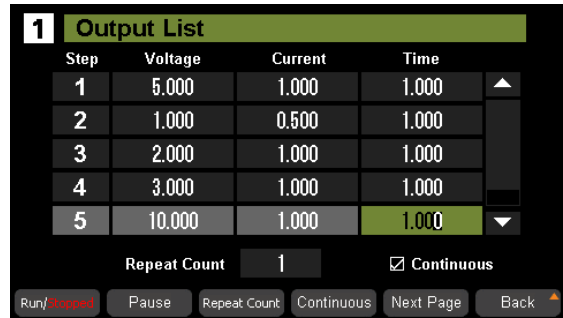

## Wave

Press **Wave** corresponding menu button on the panel to enter the list setting interface, where you can observe the real-time change of output parameters (voltage/current).

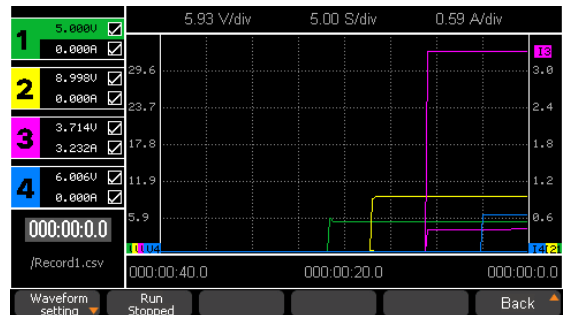

## Menu

Press **Menu** corresponding menu button on the panel to enter the menu interface. The following items can be viewed or set:

- System: Can perform operations such as viewing version information, sound settings, board test, upgrade.
- Interface: USB, LAN, GPIB can be viewed or set.
- Default Setting: Include default settings and factory settings.
- Save Recall: Include universal save/recall and list save/recall.
- Calibrate Device: Include calibrate source and Volt/Curr calibrate.

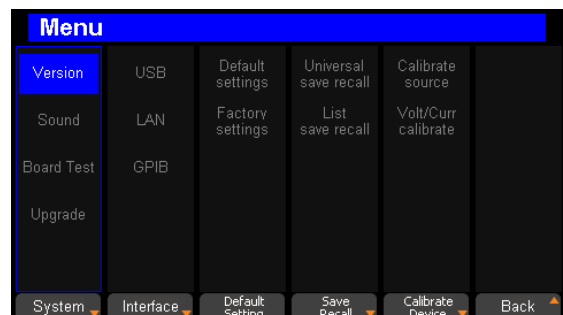

## Sense

Press **Sense** corresponding menu button on the panel to enter the sense settings interface and set CH2/CH3 4W sense mode to on or off.

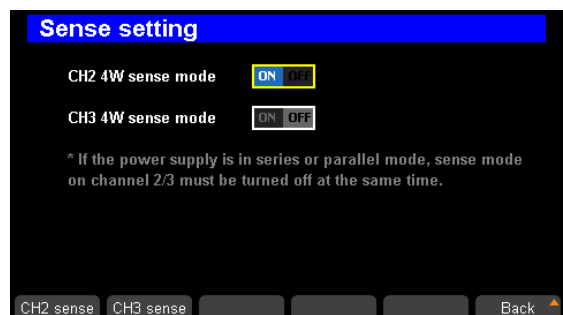

## Basic Operation

### Output Mode Setting

The SPD4000X has four sets of independently adjustable output sources, each output source supports constant voltage mode and constant current mode. The CH1/CH4 of the SPD4000X have only one independent output mode, when the CH2/CH3 have three output modes: independent, parallel and series.

In the independent mode, the output current and voltage are controlled respectively. In the parallel mode, the current value is twice that of the single channel. In the series mode, the voltage value is twice that of the single channel. When CH2 and CH3 are operating in independent mode, the 4W sense mode can be activated.

### Constant Voltage/Current Mode

The SPD4000X supports constant voltage and constant current mode. If the output load impedance value is greater than the value obtained by dividing the voltage setting by the current setting, the instrument will operate in constant voltage mode (CV). If the output load impedance is less than the value obtained by dividing the voltage setting by the current setting, the instrument will operate in constant current mode (CC).

- In constant voltage mode, the current value is less than the set value, and the voltage value is controlled through the front panel. The user interface will display CV logo at this moment, and the voltage value is maintained at the set value. It will return to constant current mode when the output current value reaches the set value.
- In constant current mode, the current value is rated and controlled through the front panel. The user interface displays the CC logo, and the current is maintained at the set value. At this point, the voltage value is under rating. It will return to constant voltage mode when the output current value is less than the set value.

### Independent Output Mode

CH1~CH4 are working in the independent mode, at the same time, they are insulated from the ground. The withstand voltage of the output terminals to the ground is  $\pm 240\text{VDC}$ .

Setting method:

1. Press **Configure** corresponding menu button on the panel to enter the configure setting interface.
2. Press **Independent** corresponding menu button on the panel, and the **Independent** under **Operation Mode** of the interface lights up, indicating that independent mode is selected. At this point, the **Parallel/Series** button light is off, and there is no serial or parallel logo on the user interface.
3. Connect the load to the terminals on the front panel: CH1 +/-, CH2 +/-, CH3 +/-, CH4 +/-.
4. Set voltage and current value of CH1/CH2/CH3/CH4:

- a) Press  /  /  /  button to select the wanted channel
  - b) Move the cursor through left/right direction button to select the wanted parameter (voltage, current)
  - c) Use the numeric keypad or knob to set the required value and then press  button to complete the value setting
5. Turn on the output: Press  button to turn on the output, the corresponding channel indicator light activates immediately, and "CC" or "CV" logo is shown on the current interface.

### CH2/CH3 Parallel Mode

In the parallel mode, the current value is twice as much as the single channel. CH2/3 are linked internally into one channel which is controlled by CH2, and CH2 reads the parallel voltage and current values.

Setting method:

1. Press  corresponding menu button on the panel to enter the configure setting interface.
2. Press  corresponding menu button on the panel to enable CH2/3 parallel mode, and the range of CH2/CH3 parallel voltage/current values under  light up, indicating that parallel mode is selected. At this point, the  button light is on, and there is "CH2/3 Parallel" logo on the user interface.
3. Connect the load to the terminals on the front panel: CH2 +/-.
4. Set voltage and current value.
  - a) Press  button to select the channel 2
  - b) Move the cursor through left/right direction button to select the wanted parameter (voltage, current)
  - c) Use the numeric keypad or knob to set the required value and press  to complete the value setting
5. Press  button corresponding CH2 to turn on the output.

### CH2/CH3 Series Mode

In the series mode, the voltage value is twice compared with that of single channel. CH2/3 are linked internally into one channel which is controlled by CH2, and CH2 reads the parallel voltage and current values.

Setting method:

1. Press  corresponding menu button on the panel to enter the configure setting interface.
2. Press  corresponding menu button on the panel to enable CH2/3 series mode, and the range of CH2/CH3 series voltage/current values under  light up, indicating that series mode is selected. At this point, the  button light is on, and there is "CH2/3 Series" logo on the user interface.
3. Connect the load to the terminals on the front panel: CH2+ & CH3-.



4. Set voltage and current value.
  - a) Press **2** button to select the channel 2
  - b) Move the cursor through left/right direction button to select the wanted parameter (voltage, current)
  - c) Use the numeric keypad or knob to set the required value and press **Enter** to complete the value setting
5. Press **On** button corresponding CH2 to turn on the output.

Note: Users can also use the **Parallel/Series** button on the front panel to select independent, parallel, or series modes directly.

#### **4W Sense Mode**

Only CH2 and CH3 can activate 4W sense mode, and 4W sense mode is not supported in series or parallel mode. When 4W sense mode is turned on and the wires are correctly connected, it can automatically compensate for the voltage drop of the positive and negative output lines, ensuring that the voltage of the remote device to be tested is equal to the set voltage of the power supply. To use this function, you need to use the voltage sense connector in the attachment.

#### **Save and Recall**

The SPD4000X supports saving the current settings to native internal storage or an external U disk, users can recall the saved file to restore the settings. If the external mode is selected, the data will be saved in the external U disk and can be recalled in the recall mode.

Eight group setups can be saved in memory. The contents of the setup file including:

- Independent/series/parallel mode
- Output voltage/current value

Save/Recall include universal save/recall and list save/recall. The following describes the operation steps for universal save/recall, with similar steps for list save/recall.

#### **Save Setting**

1. Set the state that you wanted.
2. Press **Save/Recall** button to enter the universal save interface.

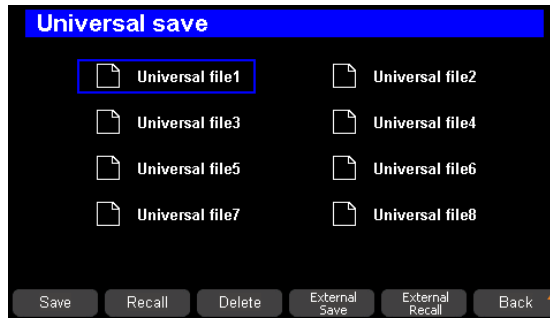

3. You can save the data to native internal storage or an external U disk by following steps.

Save the data to native internal storage:

Press the left/right direction button to select a file saving location (Universal file1 ~ Universal file8), and press the **Save** corresponding menu button on the panel to save the current settings. The prompt window "Save successfully" will pop up when the file is saved successfully.



Save the data to an external U disk:

After connecting a U disk to the SPD4000X, press **External Recall** corresponding menu button on the panel, and the data will be saved in the U disk.

### Recall Setting

1. Press **Save/Recall** button to enter the universal save interface.
2. You can recall the data to native internal storage or an external U disk by following these steps.

Recall the data from native internal storage:

Select the saved file that you want to invoke by left/right direction button. Press **Recall** corresponding menu button on the panel to recall the selected file. When the file is recalled successfully, the prompt window "Save Successfully" will pop up.

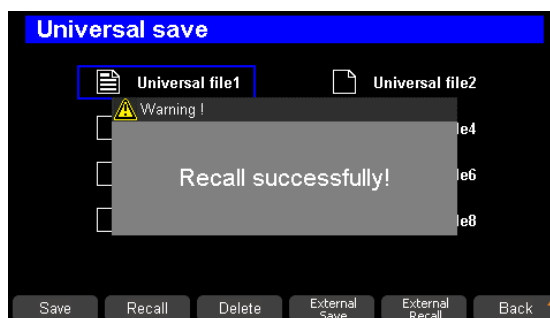



Recall the data from an external U disk:

Press the **External Recall** corresponding menu button on the panel to recall the selected file to recall the data stored on an external U disk.

Note: If you want to delete a file that has been saved before, use the left/right direction button to select the file and press **Delete** corresponding menu button on the panel to delete it.

### Lock Function

1. Press the **Lock/Unlock** button on any interface to activate the lock function.
2. When the lock function is activated, a graphic symbol  appears in the upper right corner of the interface. At this point, the buttons on the front panel will not function, but the device can be remotely controlled.
3. Long press **Lock/Unlock** button to turn off lock function, and the graphic symbol  in the upper right corner of the interface will disappear at the same time.

### Waveform Display

SPD4000X can display the changes of the output voltage and current of the channel in real time through the form of curve plotting.

Specific steps are below:

1. Set channel output parameters.
2. Press **Wave** corresponding menu button on the panel to enter the waveform display interface.
3. Select the parameter that you want to display the waveform.
4. Press the **ON** button corresponding to the selected channel to open the channel output, and then you can observe the real-time change of output parameters (voltage/current).
5. Press **Run** to save waveform data to the U disk connected to the instrument.

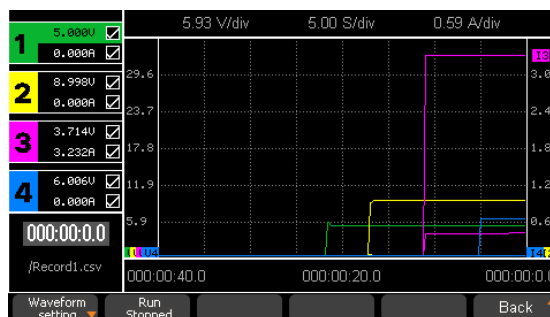

Note: The color of the output parameter waveform curve corresponds to the color of the channel.

## 🔌 List Setting

Press **List** corresponding menu button on the panel to enter the output list setting interface and set the list.

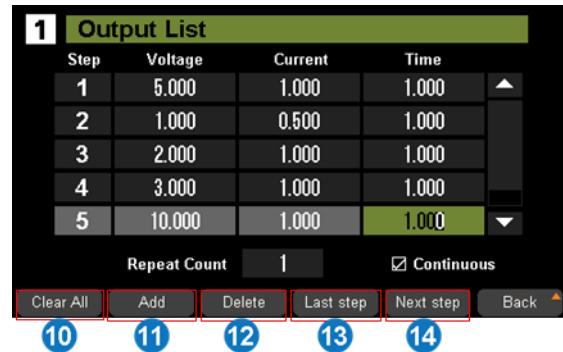
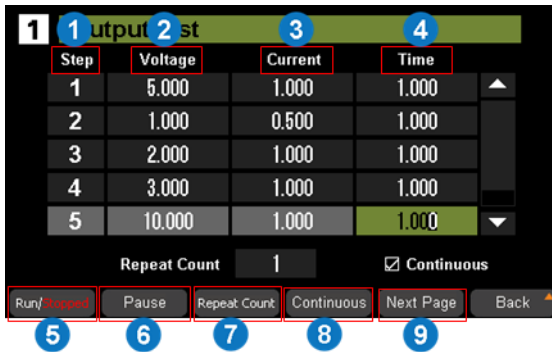

1. Step number
2. Voltage: Set the output voltage corresponding to the number of steps. Select the number of steps you want to set and use the numeric keypad or knob to set the value
3. Current: Set the output current corresponding to the number of steps. Select the number of steps you want to set and use the numeric keypad or knob to set the value
4. Time: Set the running time of the current step
5. Run/Stopped: Run/stopped the list
6. Pause: Pause the list
7. Repeat Court: The maximum is 9999
8. Continuous: Continuous loop the list
9. Next Page: Go to the next page
10. Clear All: Clear all steps in the list after confirming the setting in the pop-up window
11. Add: Add a step to the list
12. Delete: Delete the current selected step in the list
13. Last step: Edit the last step
14. Next Step: Edit the next step

## 🔌 LAN Setting

Setting method:

1. Connect the LAN port on the rear panel of the power supply to the local network using a network cable.
2. Press **Menu** > **Interface** corresponding menu button on the panel, and select **LAN** through the left/right direction button. Press the **Enter** button to enter the LAN setting interface.



3. Press the right/left direction button or press **DHCP** corresponding menu button on the panel to keep the cursor on the DHCP line, and then press **Enter** button to set DHCP to ON or OFF.
  - ON: The SPD4000X automatically sets IP address, subnet mask, and gateway based on the network it is connected to.
  - OFF: User set the IP address, subnet mask address and gateway address manually by pressing **IP** , **Subnet Mask** and **Gateway** corresponding menu button on the panel respectively, and use the numeric keypad or the knob to complete the address setting.
4. Use one of the above two methods to complete the LAN setting.
5. Press **Back** corresponding menu button on the panel to exit the LAN setting interface and return to menu interface. Press the button again to return to the main interface.

### **Version Information**

Press **Menu** > **System** corresponding menu button on the panel to select **Version** through the left/right direction button. Press **Enter** button to enter the version information display interface.

The version information includes: startup times, SPEC, software version, product type, serial number, and hardware version.

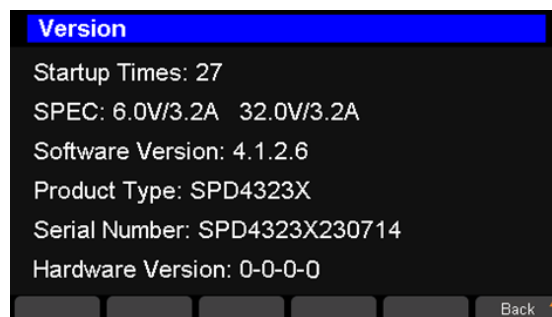

### **System upgrade**

Please follow the steps below to upgrade the firmware:

1. Download the firmware upgrade package from the official website.
2. Copy the .ADS file in the upgrade package to the root directory of the U disk.
3. Insert the U disk into the USB port of the rear panel.
4. Press **Menu** > **System** corresponding menu button, use left/right direction button to select **Upgrade** , and then press **Enter** button to confirm the selection.
5. Select the upgrade file and press **Enter** button to confirm, and the upgrade progress bar will pop up. The instrument will restart after successful upgrade. Otherwise, the upgrade failure information is displayed in the pop-up window.

Any operation that interrupts the upgrade process may cause upgrade failure or even render the machine unable to be restarted. Do not remove the U disk or make any changes to the power supply during the upgrade process.

## Remote Control

Based on the SCPI (Standard Commands for Programmable Instruments) command set, the power supply supports communication with the computer via USB and LAN to realize remote control. Please refer to the SPD4000X Series Programmable Linear DC Power Supply user manual for remote control methods, grammatical conventions, and related SCPI commands.

## More Information

You can obtain the instrument information and installation status of all options through system menu, for more information of this product, please refer to the following manuals (you can also download them from the **SIGLENT** web site).

### **SPD4000X Series Programmable Linear DC Power Supply user manual:**

Provides detailed introductions of the functions of this instrument, as well as detail introductions of the SCPI commands and programming of this instrument.

### **SPD4000X Series Programmable Linear DC Power Supply data sheet:**

Provides the main characteristics and specifications of this instrument.



**Headquarters:**

SIGLENT Technologies Co., Ltd  
Add: Bldg No.4 & No.5, Antongda Industrial  
Zone, 3rd Liuxian Road, Bao'an District,  
Shenzhen, 518101, China  
Tel: + 86 755 3688 7876  
Fax: + 86 755 3359 1582  
Email: sales@siglent.com  
Website: int.siglent.com

**North America:**

SIGLENT Technologies America, Inc  
6557 Cochran Rd Solon, Ohio 44139  
Tel: 440-398-5800  
Toll Free: 877-515-5551  
Fax: 440-399-1211  
Email: info@siglentna.com  
Website: www.siglentna.com

**Europe:**

SIGLENT Technologies Germany GmbH  
Add: Staetzlinger Str. 70  
86165 Augsburg, Germany  
Tel: +49(0)-821-666 0 111 0  
Fax: +49(0)-821-666 0 111 22  
Email: info-eu@siglent.com  
Website: www.siglenteu.com

Follow us on  
Facebook: SiglentTech

