

Service Manual

SDG2000X Series

Function/Arbitrary Waveform Generator

2016 SIGLENT TECHNOLOGIES CO., LTD

Guaranty and Declaration

Copyright

SIGLENT TECHNOLOGIES CO., LTD. All Rights Reserved.

Trademark Information

SIGLENT is the registered trademark of SIGLENT TECHNOLOGIES CO., LTD

Declaration

- **SIGLENT** products are protected by patent law in and outside of P.R.C.
- **SIGLENT** reserves the right to modify or change parts of or all the specifications or pricing policies at company's sole decision.
- Information in this publication replaces all previously corresponding material.
- Any form of copying, extracting or translating the contents of this manual is not allowed without the permission of **SIGLENT**.
- **SIGLENT** will not be responsible for losses caused by either incidental or consequential in connection with the furnishing, use or performance of this manual as well as any information contained.

Product Certification

SIGLENT guarantees this product conforms to the national and industrial standards in China as well as the ISO9001: 2008 standard and the ISO14001: 2004 standard. Other international standard conformance certification is in progress.

General Safety Summary

Carefully read the following safety precautions to avoid any personal injuries or damages to the instrument and any product connected to it. To avoid potential hazards, please use the instrument as specified.

Only qualified technical personnel should service this instrument.

Avoid fire or open flame.

Use properly rated power line connections.

Use only the specified power line which has been approved by your local regulatory agency.

Ground the Instrument.

The instrument is grounded through the protective ground conductor of the power line. To avoid electric shock, the ground conductor must be connected to the earth ground. Make sure the instrument is grounded correctly before connecting its input or output terminals.

Connect the signal wire correctly.

The potential of the signal wire ground is equal to the earth, therefore do not connect the signal wire to a high voltage. Do not touch the exposed contacts or components.

Observe all terminal ratings.

To avoid fire or electric shock, please observe all ratings and label instructions on the instrument. Before connecting the instrument, please read the manual carefully to gain more information about the ratings.

Do not operate with suspected failures.

If you suspect that the product is damaged, please allow only qualified service personnel to troubleshoot and repair it.

Avoid circuit or wire exposure.

Do not touch exposed contacts or components when the power is on.

Do not operate in wet/damp conditions.

Do not operate in an explosive atmosphere.

Keep the surface of the instrument clean and dry.

Safety Terms and Symbols

Terms used on the instrument. Terms may appear on the instrument:

DANGER: Indicates an injury or hazard that may immediately happen.

WARNING: Indicates an injury or hazard that may not immediately happen.

CAUTION: Indicates that a potential damage to the instrument or other property might occur.

Symbols used on the instrument. Symbols may appear on the instrument:



**Hazardous
Voltage**



**Protective
Earth Ground**



Warning



**Chassis
Ground**



**Power
Switch**

Catalog

Guaranty and Declaration	II
General Safety Summary	III
Overview of this Document.....	VI
The SDG2000X Series Generator at a Glance	VIII
The Front Panel at a Glance.....	IX
The Rear Panel at a Glance	XII
Chapter 1 Specifications	13
Chapter 2 Quick Start	21
To Prepare the Generator for Use	22
To Adjust the Carrying Handle.....	23
To Set the Output Frequency	24
To Set the Output Amplitude.....	26
To Set the DC offset	28
To Set the Duty Cycle of a Square Waveform.....	30
To Set the Symmetry of a Ramp Waveform	32
To Generate a Pulse Waveform	34
To Generate a Noise Waveform	37
To Set the DC Voltage	39
To Output a Built-In Arbitrary Waveform.....	41
To Use the Built-In Help System.....	43
Chapter 3 Calibration.....	44
Calibration Interval.....	44
Adjustment is Recommended	44
Automating Calibration Procedures	44
Recommended Test Equipment	44
Test Considerations	45
Performance Verification Test.....	45
DC Output Verification.....	46
AC Amplitude Verification.....	47
Frequency Response Verification	48
General Adjustment Procedure	50
Software Environment.....	51
Warming up	51
Channel Adjustment	52
Frequency Response Adjustment	57
TimeBase Calibration	58
Chapter 4 Assembly Procedures.....	59
Security Consideration	59
List of Modules	60
Required Tools.....	60
Disassembly Procedures.....	61

Chapter 5 Troubleshooting	66
ESD Precautions	66
Required Equipments	66
Channel Board Drawing	67
Main Board Drawing	68
Check the Power Supply	69
Check the Channel Board	71
Voltage Checking	71
10 MHz Clock Source Checking	72
FPGA Checking.....	72
Connector Checking.....	72
Check the Main Board	73
Voltage Checking	73
Main Board Clock Checking.....	73
ARM CPU System Checking.....	74
Connector Checking.....	74
Quick Guide for General Failures.....	75
Chapter 6 Maintenance	76
Maintain Summary.....	76
Repackaging for Shipment	76
Contact SIGLENT	77

Overview of this Document

This document is for the SDG2000X series arbitrary waveform generator, which will be mostly referred to “the generator” for short in the following text. The main contents described in this manual are:

The SDG2000X Series Generator at a Glance

This part introduces the main technology characteristics for the SDG2000X generator.

The Front Panel at a Glance

This section introduces briefly all of the buttons and the knob on the front panel.

The Rear Panel at a Glance

This section introduces the ports for easy communication on the rear panel.

Specification

Chapter 1 lists the generator’s specifications.

Quick Start

Chapter 2 describes prepare the generator for use and helps you get familiar with a few of its front-panel features.

Calibration

Chapter 3 provides calibration, verification and adjustment procedures for the generator.

Assembly Procedures

Chapter 4 provides disassembly procedures to help in gaining an understanding of the structure of the generator in preparing to install or replace any needed modules, or troubleshoot faults that might be encountered during operation.

Troubleshooting

Chapter 5 provides troubleshooting procedures for the internal circuit boards, as well as a quick guide for solving general problems. Before any operation, please read the ESD Precautions to avoid personal injuries or damages to the generator.

Maintenance

Chapter 6 provides information on maintenance, daily care and unpacking

inspection of the instrument. The contact information is included at the end of the chapter in case of some unsolvable troubles that might be encountered.

The Different SDG2000X Models Addressed by this Manual

All the description for function and performance in this document are according to the SDG2122X series generator, and apply to generator of the other types. The SDG2000X series contains the following types:

Type	Analog Bandwidth	Channels
SDG2042X	40 MHz	2
SDG2082X	80 MHz	2
SDG2122X	120 MHz	2

The SDG2000X Series Generator at a Glance

SIGLENT's SDG2000X is a series of dual-channel function/arbitrary waveform generators with specifications of up to 120 MHz maximum bandwidth, 1.2GSa/s sampling rate and 16-bit vertical resolution. The proprietary TrueArb & EasyPulse techniques help to solve the weaknesses inherent in traditional DDS generators when generating arbitrary, square and pulse waveforms. Using these techniques the SDG2000X provides users with a variety of high fidelity, low jitter signals in order to meet the growing requirements for a multitude of complex applications.

Characteristics

The powerful feature set for the SDG2000X generator family includes:

- ◆ Dual-channel, 120 MHz maximum bandwidth, 20 Vpp maximum output amplitude, high fidelity output with 80dB dynamic range
- ◆ High-performance sampling system with 1.2 GSa/s sampling rate and 16-bit vertical resolution. No detail in your waveforms will be lost
- ◆ Innovative TrueArb technology, based on a point-by-point architecture, supports any 8 pts ~ 8 Mpts Arb waveform with a sampling rate in range of 1 μ Sa/s ~ 75 MSa/s
- ◆ Innovative Easy Pulse technology, capable of generating lower jitter Square or Pulse waveforms, brings a wide range and extremely high precision in pulse width and rise/fall times adjustment
- ◆ Plenty of analog and digital modulation types: AM、DSB-AM、FM、PM、FSK、ASK、PSK and PWM
- ◆ Sweep and Burst function
- ◆ High precision Frequency Counter
- ◆ Standard interfaces: USB Host, USB Device (USBTMC) , LAN (VXI-11)
Optional interface: GPIB
- ◆ 4.3" touch screen display for easier operation

Note: All the specifications described in this manual refer to the SDG2122X.

The Front Panel at a Glance

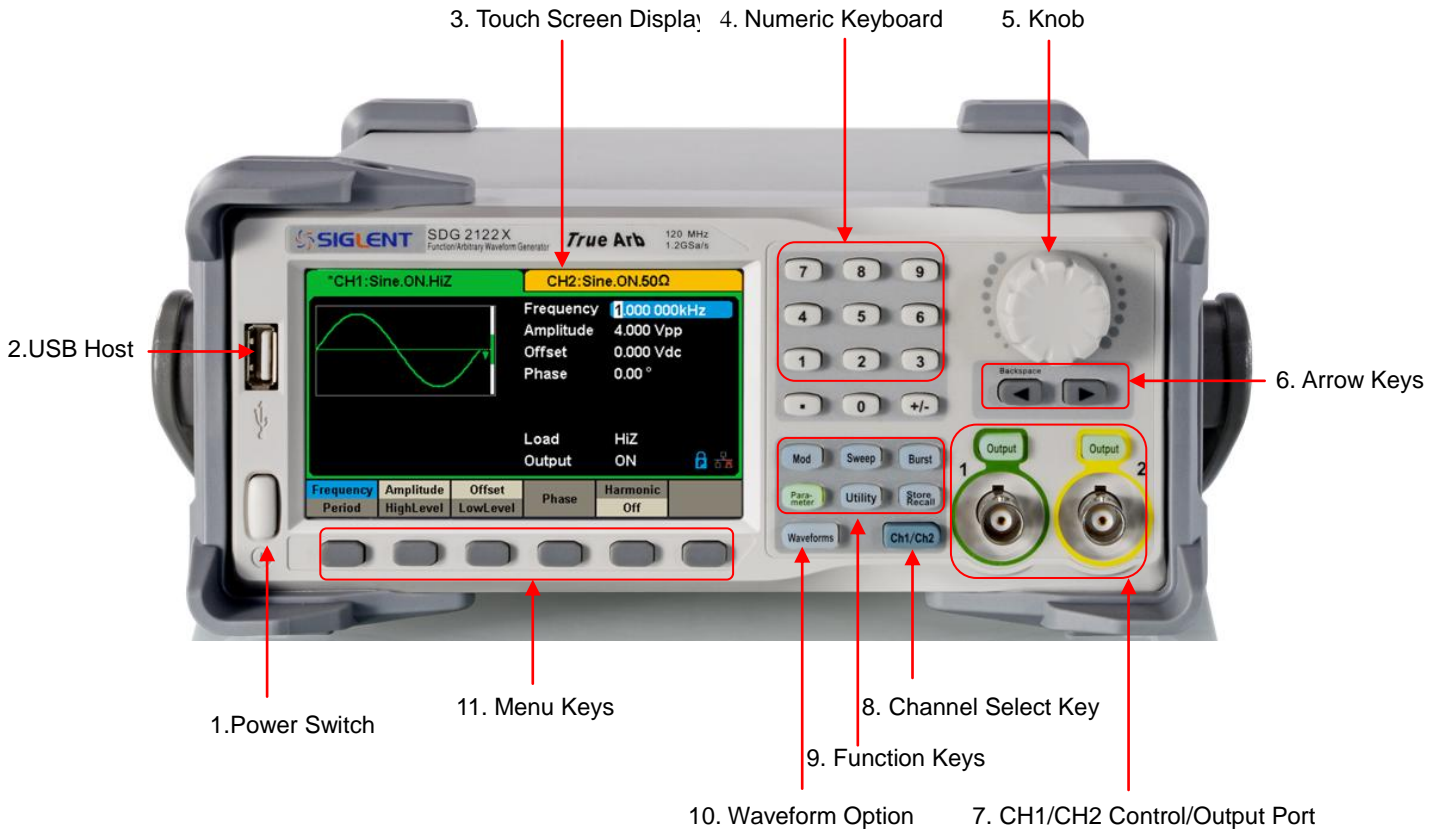

The User Interface at a Glance

SDG1000X can only display parameters and waveform for one channel at a time. The picture below shows the interface when CH1 is selected and AM modulation of a sine wave function is selected. The information displayed may vary depending on the function selected.

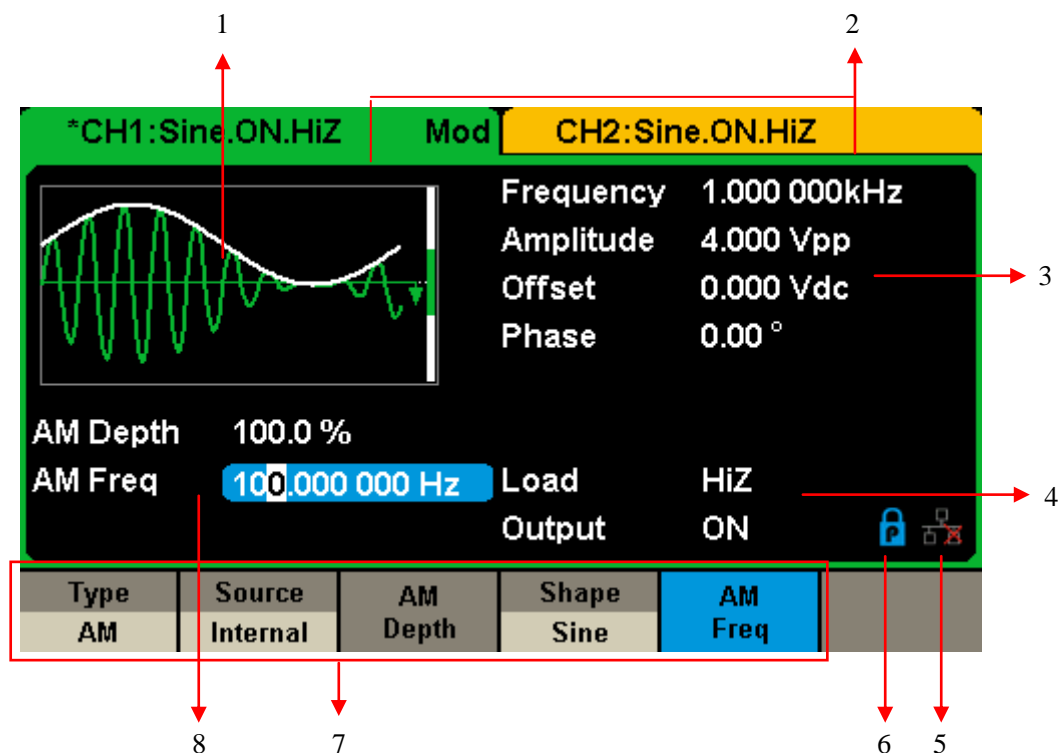

1. Waveform Display Area

Displays the currently selected waveform of each channel.

2. Channel Status Bar

Indicates the selected status and output configuration of the channels.

3. Basic Waveform Parameters Area

Shows the current waveform's parameters for the selected channel. Press **Parameter** and select the corresponding softkey to highlight the parameter to configure. Then use number keys or knob to change the parameter value.

4. Channel Parameters Area

Displays the load and output settings of the currently selected channel.

Load ----Value of the output load, as selected by the user.

Press **Utility** → **Output** → **Load**, then use the softkeys, number keys or knob to change the parameter value; or continue pressing the corresponding output key for two second to switch between High Impedance and 50 Ω .

High Impedance: display HiZ.

Load: display impedance value (the default is 50 Ω and the range is 50 Ω to 100 k Ω).

Note: This setting does not actually change the instrument's output impedance of 50 Ω but rather is used to maintain amplitude accuracy into different load values.

Output ----Channel output state.

After pressing corresponding channel output control port, the current channel can be turned on/off.

5. LAN Status Icon

The SDG2000X will show different prompt messages based on the current network status.



This mark indicates LAN connection is successful.



This mark indicates there is no LAN connection or LAN connection is unsuccessful.

6. Mode Icon

The SDG2000X will show different prompt messages based on the current choosing status of the mode.



This mark indicates current mode is Phase-locked.



This mark indicates current mode is Independent.

7. Menu

Shows the menu corresponding to the displayed function. For example, Figure 4 shows the parameters of “AM modulation”.

8. Modulation Parameters Area

Shows the parameters of the current modulation function. After selecting the corresponding menu, use number keys or knob to change the parameter value.

The Rear Panel at a Glance

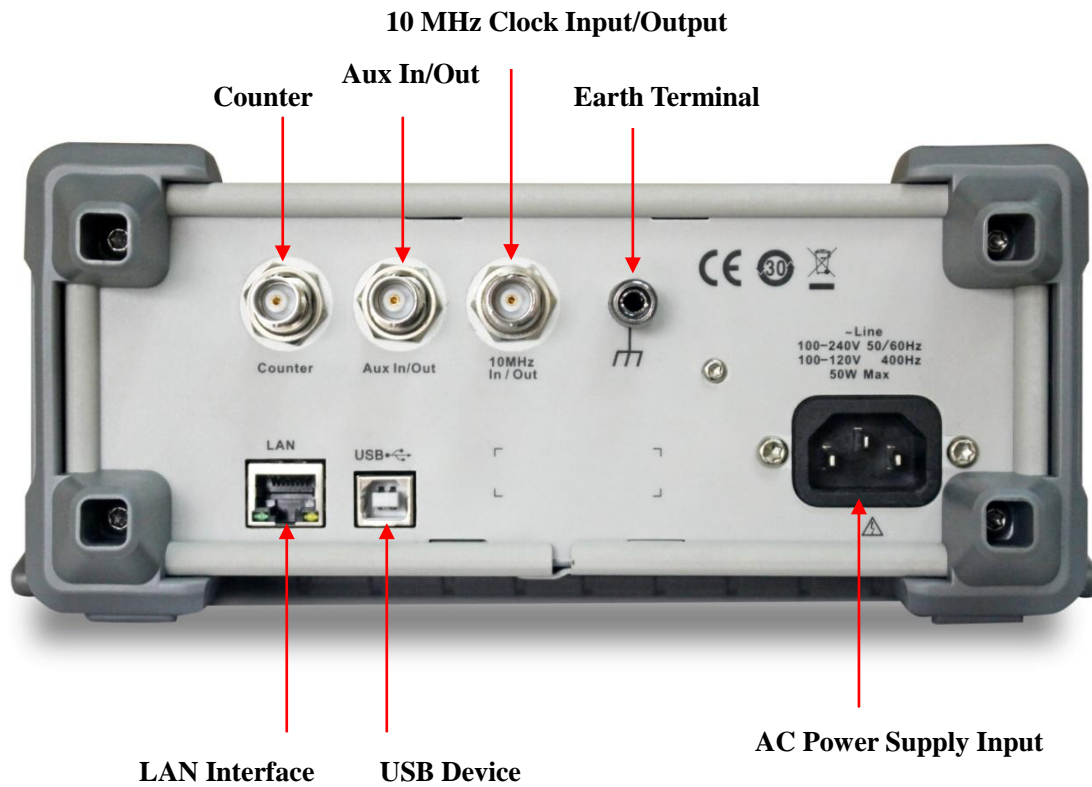

WARNING: For protection from electric shock, the grounding power cord must not be defeated. If only a two-contact electrical outlet is available, connect the instrument's chassis ground screw (see above) to a good earth ground.

Chapter 1 Specifications

These specifications apply to the SDG2000X series Arbitrary Waveform Generators. To verify that a generator meets the specifications, it must first meet the following conditions:

- The generator must have been operating continuously for thirty minutes within the specified operating 18 °C ~ 28 °C temperature.
- The generator must be within the factory calibration interval of one year.

Frequency Characteristics					
Parameter	Min.	Typ.	Max.	Unit	Condition
Resolution			1μ	Hz	
Initial accuracy	-1		+1	ppm	25 °C
	-2		+2	ppm	0~40 °C
1 st -year aging	-1		+1	ppm	25 °C
10-year aging	-3.5		+3.5	ppm	25 °C

Sine Characteristics					
Parameter	Min.	Typ.	Max.	Unit	Condition
Frequency	1μ		120M	Hz	
Harmonic distortion			-65	dBc	0 dBm, 0~10 MHz (Included)
			-60	dBc	0 dBm, 10~20 MHz (Included)
			-55	dBc	0 dBm, 20~40 MHz (Included)
			-50	dBc	0 dBm, 40~60 MHz (Included)
			-45	dBc	0 dBm, 60~80 MHz (Included)
			-40	dBc	0 dBm, 80~100 MHz (Included)
Total Harmonic Distortion			-38	dBc	0 dBm, 100~120 MHz (Included)
			0.075	%	0 dBm, 10 Hz ~ 20 kHz
Non-harmonic spurious			-70	dBc	≤50 MHz
			-65	dBc	>50 MHz

Square Characteristics					
Parameter	Min.	Typ.	Max.	Unit	Condition
Frequency	1μ		25M	Hz	
Rise/fall times			9	ns	10% ~ 90%, 1 Vpp, 50 Ω Load
Overshoot			3	%	100 kHz, 1 Vpp, 50 Ω Load
Duty cycle	0.001		99.999	%	Limited by frequency setting

Square Characteristics					
Jitter (rms), Cycle to cycle			150	ps	1 Vpp, 50 Ω Load

Pulse Characteristics					
Parameter	Min.	Typ.	Max.	Unit	Condition
Frequency	1μ		25M	Hz	
Pulse width	16.3			ns	
Pulse width accuracy			±(0.01%+0.3ns)		
Rise/fall times	8.4n		22.4	s	10% ~ 90%, 1 Vpp, 50 Ω Load, Subject to pulse width limits
Overshoot			3	%	100 kHz, 1 Vpp
Duty cycle	0.001		99.999	%	Limited by frequency setting
Duty cycle resolution	0.001			%	
Jitter (rms) cycle to cycle			150	ps	1 Vpp, 50 Ω Load

Ramp Characteristics					
Parameter	Min.	Typ.	Max.	Unit	Condition
Frequency	1μ		1M	Hz	
Symmetry	0		100	%	
Linearity			1	%	Percentage of peak-peak output, 1 kHz, 1 Vpp, 100% symmetry

Noise Characteristics					
Parameter	Min.	Typ.	Max.	Unit	Condition
-3dB bandwidth	120			MHz	

Arbitrary Wave Characteristics					
Parameter	Min.	Typ.	Max.	Unit	Condition
Frequency	1μ		20M	Hz	
Waveform length	8		8M	pts	
Sampling rate	1μ		75M	Sa/s	TrueArb mode
	300			MSa/s	DDS mode
Vertical solution	16			bit	
Jitter (rms)			150	ps	1 Vpp, 50 Ω Load, TrueArb mode

DC Characteristics					
Parameter	Min.	Typ.	Max.	Unit	Condition
Range	-10		10	V	HiZ load
	-5		5	V	50 Ω Load
Accuracy	±(1%+2 mV)				HiZ load

Output Characteristics					
Parameter	Min.	Typ.	Max.	Unit	Condition
Range (Note 1)	2m		20	Vpp	≤20 MHz, HiZ load
	2m		10	Vpp	>20 MHz, HiZ load
Accuracy	±(1%+1mVpp)				10 kHz Sine, 0 V offset,
Amplitude flatness	-0.3		+0.3	dB	0~100 MHz (Included), 50 Ω Load, 2.5 Vpp, compare to 10 KHz Sine
	-0.4		+0.4	dB	100~120 MHz (Included), 50 Ω Load, 2.5 Vpp, compare to 10 KHz Sine
Output impedance	49.5	50	50.5	Ω	10 KHz Sine
Output current	-200		200	mA	
Crosstalk			-60	dBc	CH1 - CH2, and CH2 - CH1

Note 1: The specification will be divided by 2 when applied to a 50 Ω Load.

Modulation Characteristics					
AM					
Parameter	Min.	Typ.	Max.	Unit	Condition
Carrier	Sine, Square, Ramp, Arb				
Modulation Source	Internal/External				
Modulating wave	Sine, Square, Ramp, Noise, Arb				
Modulation depth	0		120	%	
Modulation frequency	1m		1M	Hz	While modulation source is "Internal"
FM					
Parameter	Min.	Typ.	Max.	Unit	Condition
Carrier	Sine, Square, Ramp, Arb				
Modulation Source	Internal/External				
Modulating	Sine, Square, Ramp, Noise, Arb				

Modulation Characteristics					
wave					
Frequency deviation	0		0.5*B W		BW is the max. output frequency Limited by frequency setting
Modulation frequency	1m		1M	Hz	While modulation source is "Internal"
PM					
Parameter	Min.	Typ.	Max.	Unit	Condition
Carrier	Sine, Square, Ramp, Arb				
Modulation Source	Internal/External				
Modulating wave	Sine, Square, Ramp, Noise, Arb				
Phase deviation	0		360	°	
Modulation frequency	1m		1M	Hz	While modulation source is "Internal"
ASK					
Parameter	Min.	Typ.	Max.	Unit	Condition
Carrier	Sine, Square, Ramp, Arb				
Modulation Source	Internal/External				
Modulating wave	Square with 50% duty cycle				
Keying frequency	1m		1M	Hz	Limited by frequency setting while modulation source is "Internal"
FSK					
Parameter	Min.	Typ.	Max.	Unit	Condition
Carrier	Sine, Square, Ramp, Arb				
Modulation Source	Internal/External				
Modulating wave	Square with 50% duty cycle				
Modulation frequency	1m		1M	Hz	While modulation source is "Internal"
PWM					
Parameter	Min.	Typ.	Max.	Unit	Condition
Carrier	Pulse				
Modulation Source	Internal/External				
Modulating wave	Sine, Square, Ramp, Noise, Arb				

Modulation Characteristics					
Modulation frequency	1m		1M	Hz	While modulation source is "Internal"
Pulse width deviation resolution	6.67			ns	

Burst Characteristics					
Parameter	Min.	Typ.	Max.	Unit	Condition
Carrier	Sine, Square, Ramp, Pulse, Noise, Arb				
Type	Count(1-1000000cycles), Infinite, Gated				
Carrier frequency	2m		BW	Hz	BW is the max. output frequency
Start/Stop phase	0		360	°	
Internal period	1μ		1000	s	
Trigger source	Internal, External, Manual				
Gated source	Internal /External				
Trigger delay			100	s	

Sweep Characteristics					
Parameter	Min.	Typ.	Max.	Unit	Condition
Carrier	Sine, Square, Ramp, Arb				
Type	Linear, Log				
Direction	Up, Down				
Carrier frequency	1μ		BW	Hz	BW is the max. output frequency
Sweep time	1m		500	s	
Trigger source	Internal, External, Manual				

Frequency Counter Characteristics					
Parameter	Min.	Typ.	Max.	Unit	Condition
Function	Frequency, Period, Positive/Negative pulse width, Duty cycle				
Coupling mode	AC, DC, HFREJ				
Frequency range	100m		200M	Hz	DC coupling
	10		200M	Hz	AC coupling
Input amplitude	100mV rms		±2.5 V		DC coupling, < 100 MHz
	200mV		±2.5 V		DC coupling, 100 MHz ~ 200

Frequency Counter Characteristics					
	rms				MHz
	100mV rms		5 Vpp		AC coupling, < 100 MHz
	200mV rms		5 Vpp		AC coupling, 100 MHz ~ 200 MHz
Input impedance		1M		Ω	

Reference Clock Input/Output					
Reference Clock Input					
Parameter	Min.	Typ.	Max.	Unit	Condition
Frequency		10M		Hz	
Amplitude	1.4			Vpp	
Input impedance	5			k Ω	AC coupling
Reference Clock Output					
Parameter	Min.	Typ.	Max.	Unit	Condition
Frequency		10M		Hz	Synchronized to internal reference clock
Amplitude	2	3.3		Vpp	HiZ load
Output impedance		50		Ω	

Auxiliary In/Out Characteristics					
Trigger Input					
Parameter	Min.	Typ.	Max.	Unit	Condition
V _{IH}	2		5.5	V	
V _{IL}	-0.5		0.8	V	
Input impedance	100			k Ω	
Pulse width	100			ns	
Response time			100	ns	Sweep
			600	ns	Burst
Trigger Output					
Parameter	Min.	Typ.	Max.	Unit	Condition
V _{OH}	3.8			V	I _{OH} = -8 mA
V _{OL}			0.44	V	I _{OL} = 8 mA
Output impedance		100		Ω	
Frequency			1	MHz	
Sync Output					
Parameter	Min.	Typ.	Max.	Unit	Condition

Auxiliary In/Out Characteristics					
V _{OH}	3.8			V	I _{OH} = -8 mA
V _{OL}			0.44	V	I _{OL} = 8 mA
Output impedance		100		Ω	
Pulse width		500		ns	
Frequency			1	MHz	
Modulation Input					
Parameter	Min.	Typ.	Max.	Unit	Condition
Frequency	0		50	kHz	
Input impedance	10			kΩ	
Amplitude@ 100% Modulation depth	11	12	13	V _{pp}	

General Characteristics					
Power					
Parameter	Min.	Typ.	Max.	Unit	Condition
Voltage	100 - 240 V _{rms} (± 10%), 50 / 60 Hz 100 - 120 V _{rms} (± 10%), 400 Hz				
Power consumption		25.5	50	W	Dual channels, Sine, 1 kHz, 10 V _{pp} , 50 Ω load
Display					
Parameter	Min.	Typ.	Max.	Unit	Condition
Color depth		24		bit	
Contrast ratio		350:1			
Luminance		300		cd/m ²	
Touch panel type	Resistive				
Environment					
Parameter	Min.	Typ.	Max.	Unit	Condition
Operating temperature	0		40	°C	
Storage temperature	-20		60	°C	
Operating humidity	5		90	%	≤ 30 °C
	5		50	%	40 °C
Non-operating humidity	5		95	%	
Operating altitude			3048	m	≤ 30 °C

General Characteristics					
Non-operating altitude			15000	m	
Calibration					
Parameter	Min.	Typ.	Max.	Unit	Condition
Calibration interval		1		year	
Mechanical					
Parameter	Min.	Typ.	Max.	Unit	Condition
Dimensions	W×H×D = 260.3mm×107.2mm×295.7mm				
Net weight		3.43		kg	
Gross weight		4.42		kg	
Compliance					
LVD	IEC 61010-1:2010				
EMC	EN61326-1:2013				

Chapter 2 Quick Start

One of the first things you will want to do with your generator is to become acquainted with the front panel. We have written the exercises in this chapter to prepare the instrument for use and help you get familiar with some of its front-panel operations. This chapter is divided into the following sections:

- To Prepare the Generator for Use
- To Adjust the Carrying Handle
- To Set the Output Frequency
- To Set the Output Amplitude
- To Set a DC Offset Voltage
- To Set the Duty Cycle of a Square Waveform
- To Set the Symmetry of a Ramp Waveform
- To Configure a Pulse Waveform
- To Configure a Noise Waveform
- To Set the DC Voltage
- To Output a Built-In Arbitrary Waveform
- To Use the Built-In Help System

To Prepare the Generator for Use

1. Check the list of accessories

Accessories supplied with the instrument are listed below. If anything is missing or damaged, please contact your nearest **SIGLENT** Sales Office.

- A Quick Start
- A Certification
- A Guaranty Card
- A CD (EasyWave software, Datasheet and User Manual)
- A power cord designed for use in the destination country
- A USB cable
- A BNC cable

2. Connect the power cord and turn on the generator

The instrument runs a short power-on self-test, which takes several seconds.

The generator powers up in the *sine wave* function at 1 kHz with an amplitude of 4 V peak-to-peak (CH1). At power-on, the Output connector is disabled. To enable the Output connector, press the **Output** key.

If the generator does not turn on, verify that the power cord is firmly connected to the power socket on the rear panel (the power-line voltage is automatically sensed at power-on). Also, make sure that the generator is connected to a power source that is energized.

Then, verify that the generator is turned on.

Note: *If the power-on self-test fails, the generator may stop and display a black screen. For solutions, please contact the nearest **SIGLENT** sales office or return the generator to **SIGLENT** for service.*

To Adjust the Carrying Handle

To adjust the position, grasp the handle by the sides and pull outward. Then, rotate the handle to the desired position.

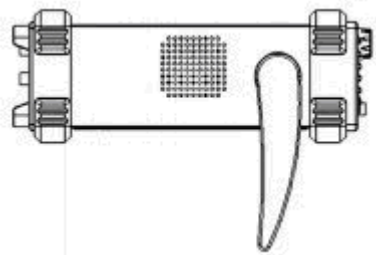
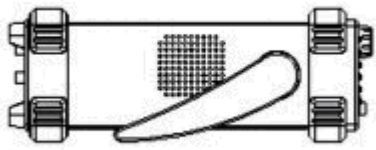

Pull the handle down

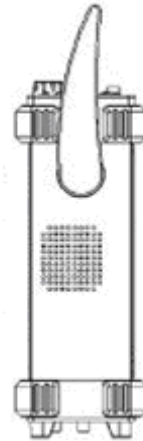

Pull the handle ahead for easy carrying

To Set the Output Frequency

The following steps explain change the frequency to 20 KHz.

1. Press the **Parameter** softkey

Press the **Parameter** softkey to enter the parameter set interface. The waveform parameters including Frequency/Period, Amplitude/HighLevel, Offset/LowLevel and Phase are ready to modify using the numeric keypad.

2. Press the **Frequency/Period** softkey

The displayed frequency is either the power-on value or the frequency previously selected. When changing the function, the same frequency is used if the current value is valid for the new waveform. To set the period, press the softkey again to switch to the period parameter

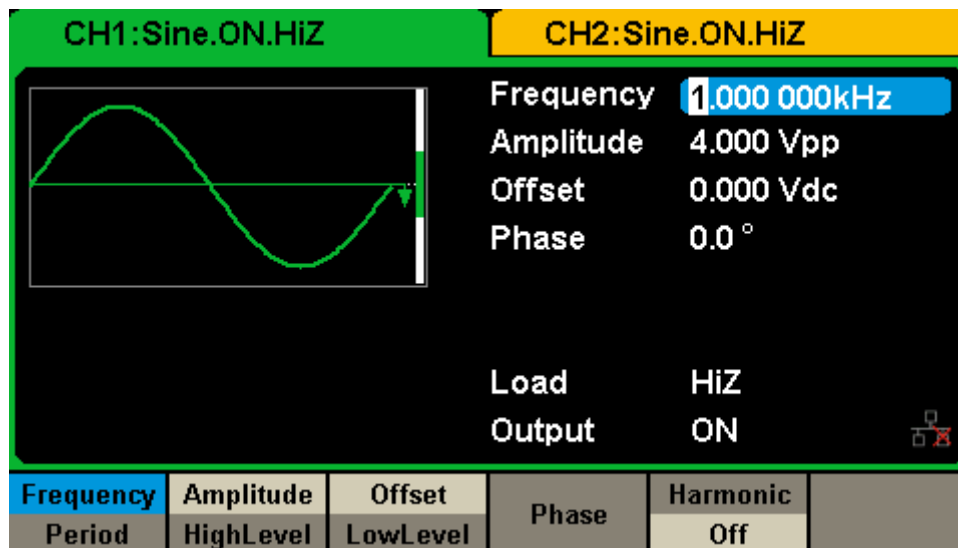

3. Input the desired frequency

Use the digital keypad to input the value directly, enter the value "20".

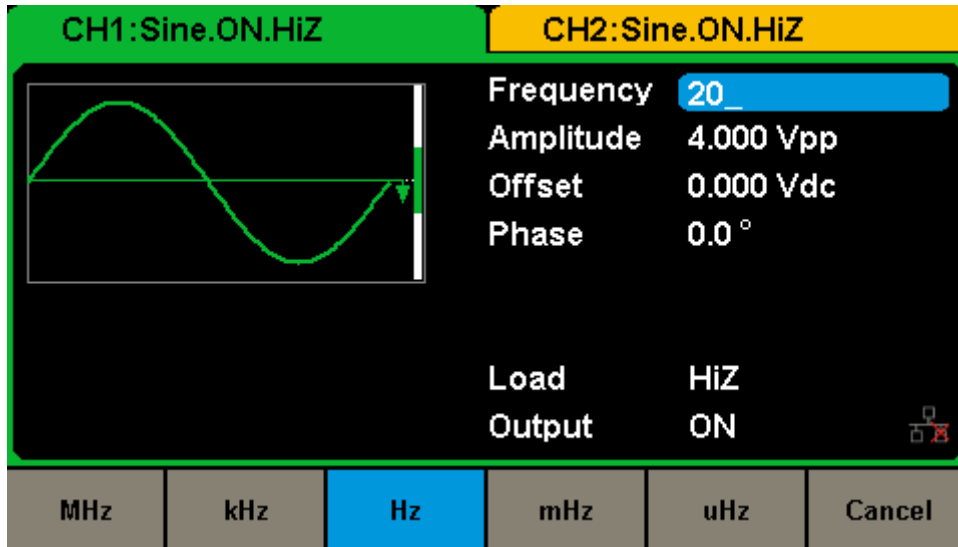

Then press the corresponding softkey to select the desired unit. For example, press **kHz**.

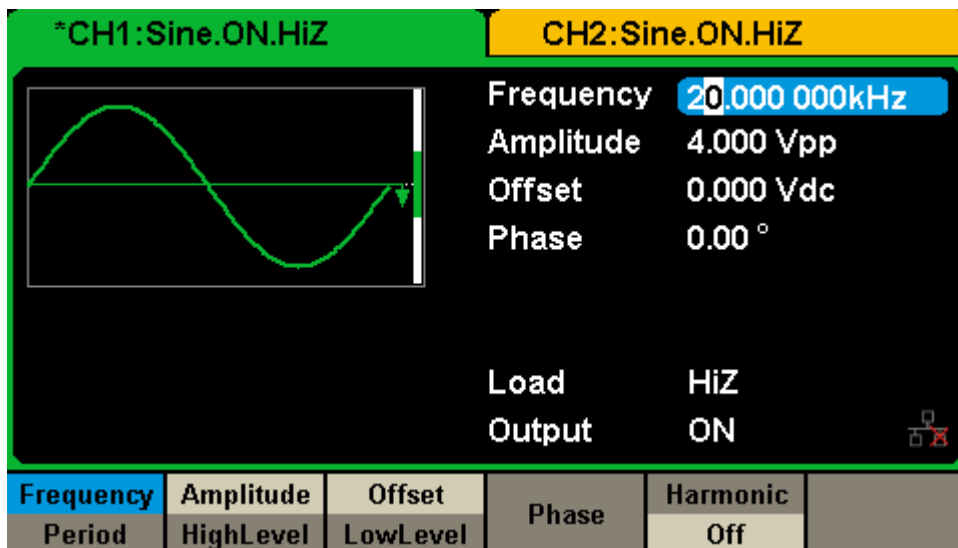

Note: The desired numerical value can be modified using the knob and direction keys.

To Set the Output Amplitude

The following steps describe how to change the amplitude to 8 Vpp.

1. Press the **Amplitude/HighLevel** softkey

The displayed amplitude is either the power-on value or the amplitude previously selected. When changing the function, the same amplitude is used if the current value is valid for the new waveform. To set the HighLevel for the waveform, press the softkey again to switch to the HighLevel parameter.

2. Input the desired amplitude

Use the digital keypad to input the value directly, enter the value “8”.

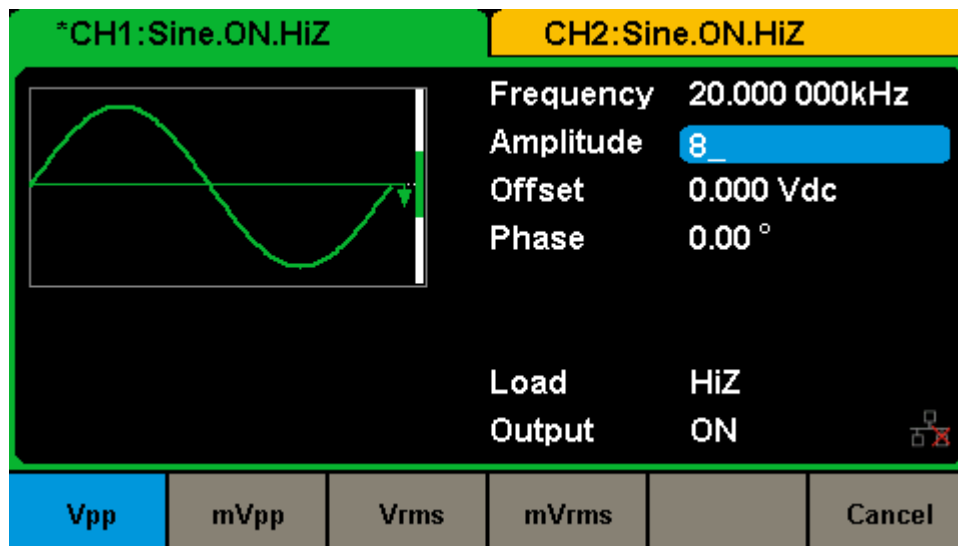

Then press the corresponding softkey to select the desired unit. For example, press **Vpp**.

*CH1:Sine.ON.HiZ
CH2:Sine.ON.HiZ

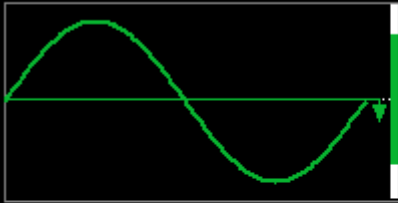

Frequency 20.000 000kHz

Amplitude **8.000 Vpp**

Offset 0.000 Vdc

Phase 0.00 °

Load HiZ

Output ON



Frequency	Amplitude	Offset	Phase	Harmonic	
Period	HighLevel	LowLevel		Off	

To Set the DC offset

The following steps describe how to change offset to 1 Vdc.

1. Press the **Offset/LowLevel** softkey

The displayed offset is either the power-on value or the offset previously selected. When changing the function, the same offset is used if the current value is valid for the new waveform. To set the LowLevel for the waveform, press the softkey again to switch to the LowLevel parameter.

2. Input the desired offset

Use the digital keypad to input the value directly, enter the value “1”.

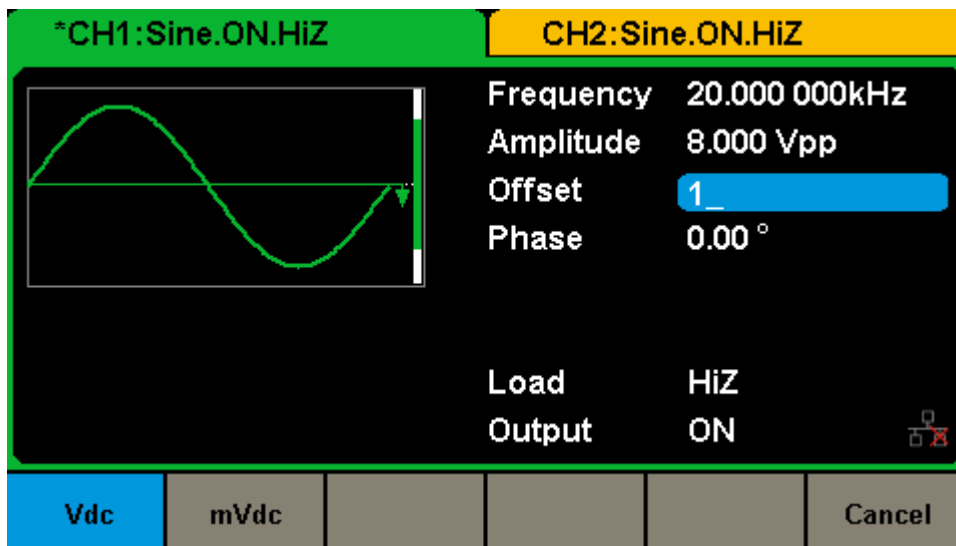

Then press the corresponding softkey to select the desired unit. For example, press **Vdc**.

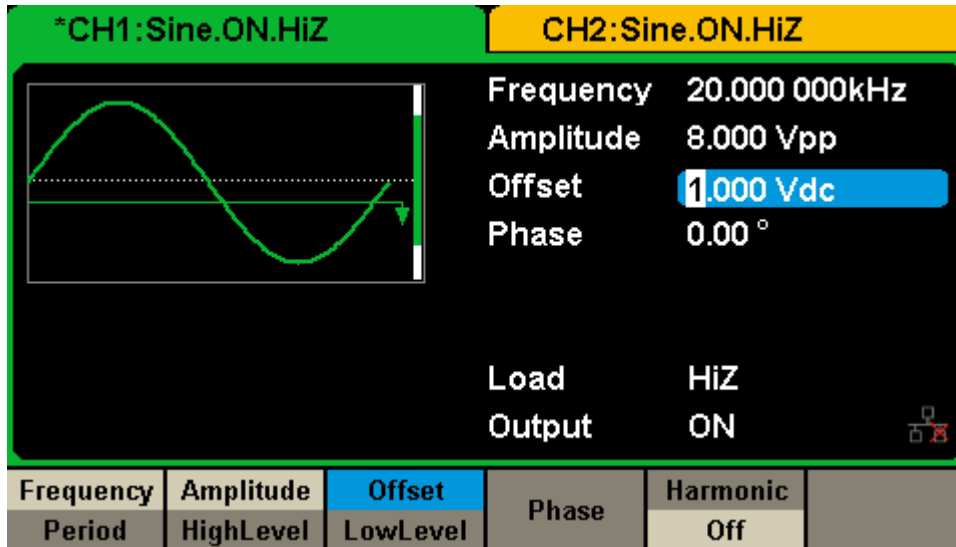

Note: The desired numerical value can be modified using the knob and direction keys.

To Set the Duty Cycle of a Square Waveform

At power-on, the default duty cycle for square wave is 50%. The duty cycle setting range is limited by the “Frequency/Period” setting. The following steps show how to change the duty cycle to 80%.

1. Select the square wave function

Press **Waveforms** → **Square** to select the square function and then select the desired output frequency to 1 kHz.

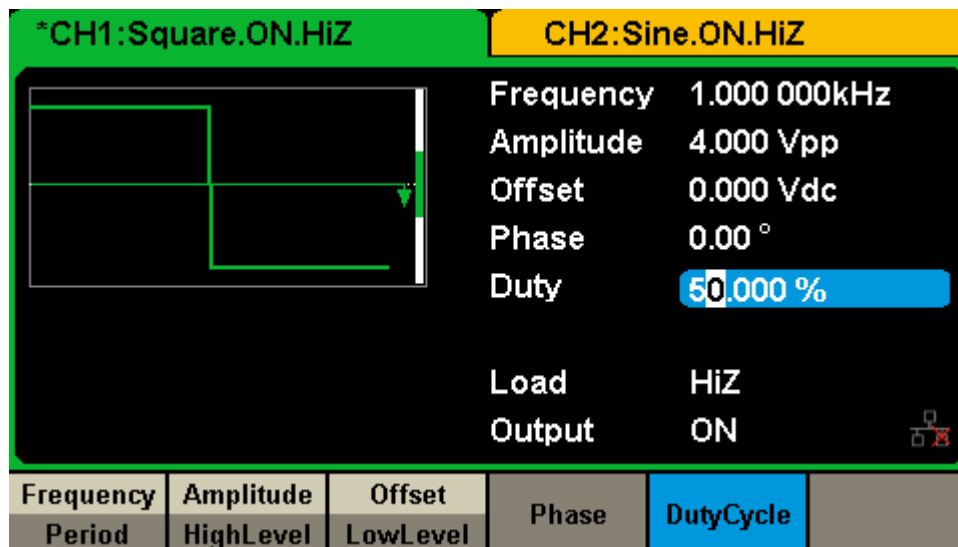

2. Press the **DutyCycle** softkey

The displayed duty is either the power-on value or the percentage previously selected.

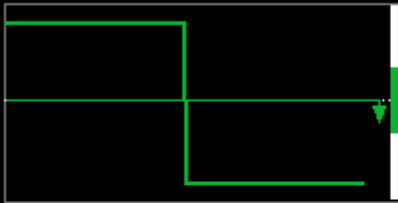

3. Input the desired duty

Use digital keypad to input the value directly, enter the value “80”, then press the corresponding softkey to select the desired unit “%”.

*CH1:Square.ON.HiZ		CH2:Sine.ON.HiZ	
	Frequency	1.000 000kHz	
	Amplitude	4.000 Vpp	
	Offset	0.000 Vdc	
	Phase	0.00 °	
	Duty	80_	
	Load	HiZ	
	Output	ON	
			
		%	Cancel

To Set the Symmetry of a Ramp Waveform

At power-on, the Symmetry for Ramp wave is 50%. The symmetry can be adjusted between 0% and 100%. The following steps describe the procedure to set the symmetry to 60%.

1. Select the Ramp wave function

Press **Waveforms** → **Ramp** to select the pulse function and then select the desired output frequency to 1 MHz.

2. Press the **Symmetry** softkey

The displayed symmetry is either the power-on value or the percentage previously selected.

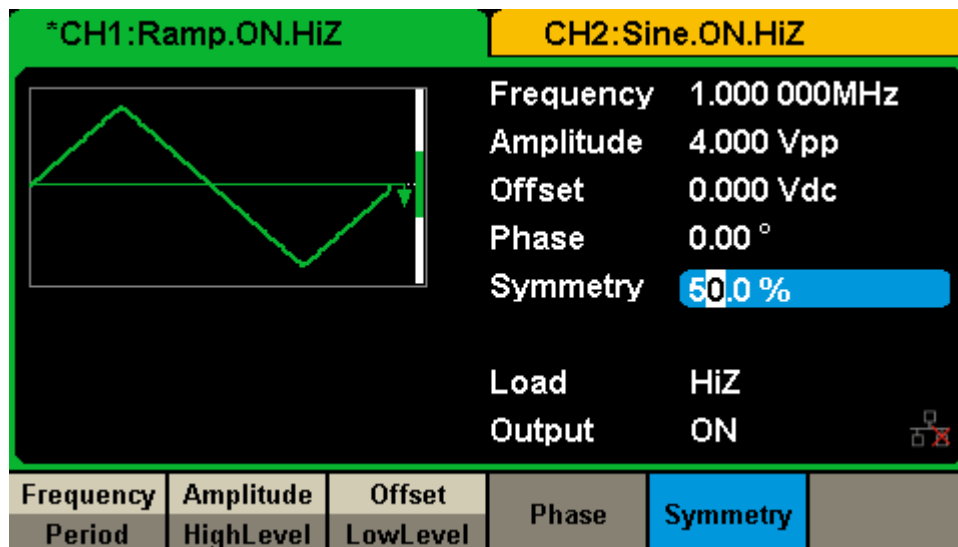

3. Input the desired symmetry

Use digital keypad to input the value directly, enter the value “60”, then press the corresponding softkey to select the desired unit “%”.

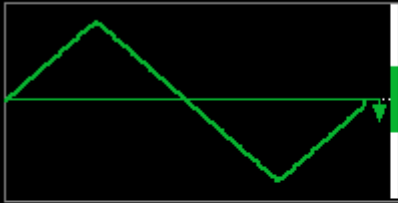
*CH1: Ramp.ON.HiZ		CH2: Sine.ON.HiZ	
	Frequency	1.000 000MHz	
	Amplitude	4.000 Vpp	
	Offset	0.000 Vdc	
	Phase	0.00 °	
	Symmetry	60_	
	Load	HiZ	
Output	ON		
		%	Cancel

To Generate a Pulse Waveform

The generator can be set to output a pulse waveform with variable width, edge time and delay time. The following steps show you how to generate a 500 μ s period pulse waveform with a pulse width of 100 μ s, rise time of 8 ns and delay time of 50 ns.

1. Select the pulse function

Press **Waveforms** → **Pulse** to select the pulse function and output a pulse waveform with the default parameters.

2. Set the Pulse period

Press the **Frequency/Period** softkey twice and then set the period to 500 μ s.

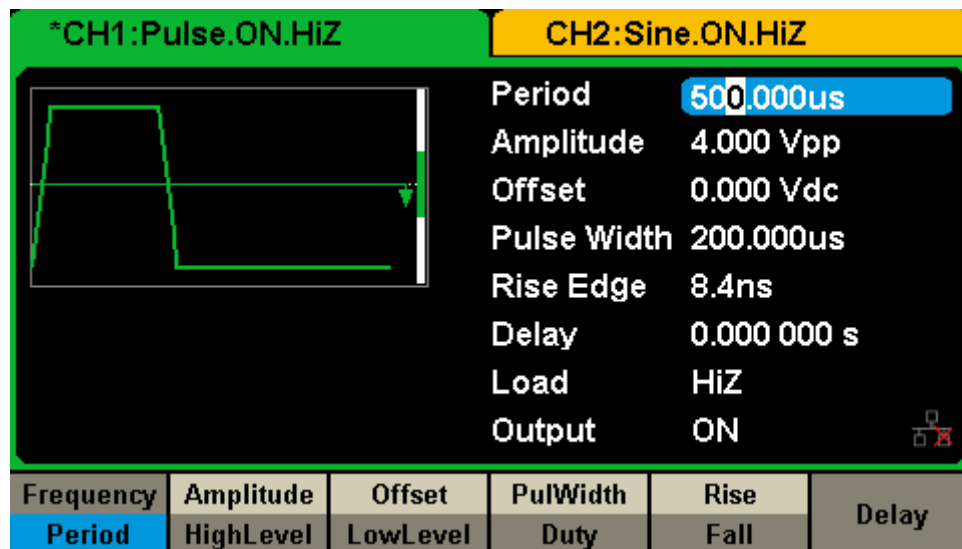

3. Set the Pulse Width

Press the **PuWidth/Duty** softkey and then set the pulse width to 100 μ s. The pulse width represents the time from the 50% threshold of the rising edge to the 50% threshold of the next falling edge.

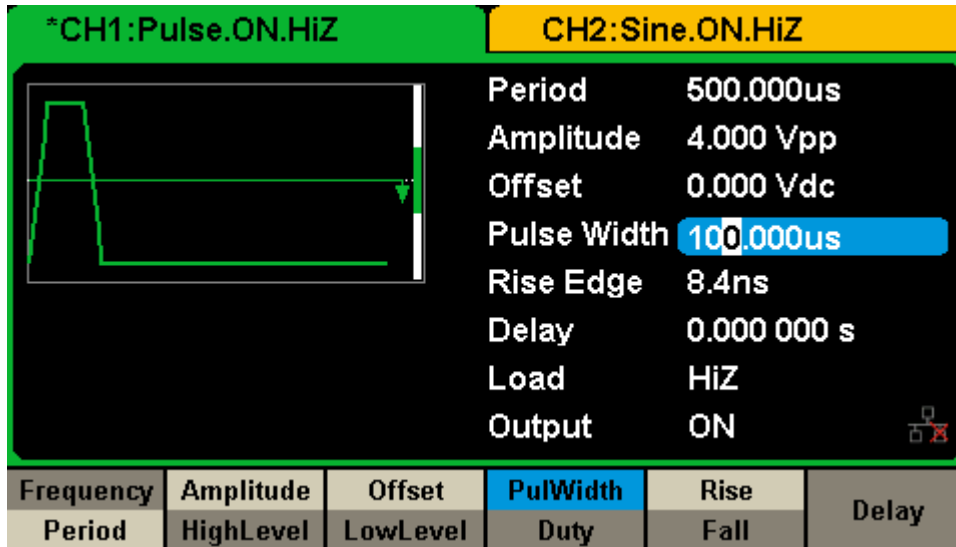

4. Set the Edge Time

Press the **Rise/Fall** softkey and then set the rising edge to 10 ns.

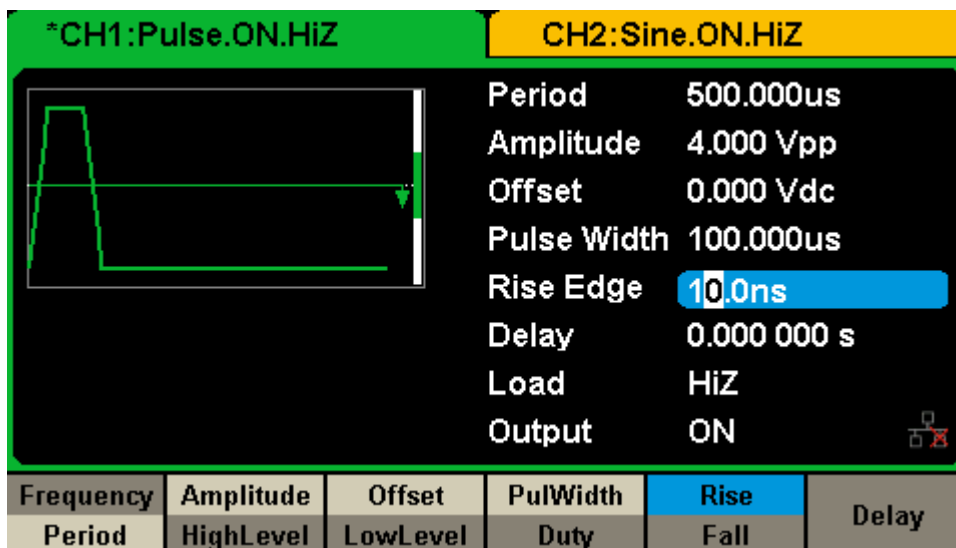

5. Set the Pulse Delay

Press the **Delay** softkey and then set the delay time to 50 ns.

*CH1:Pulse.ON.HiZ

CH2:Sine.ON.HiZ

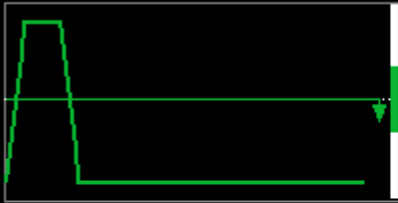

Period 500.000us

Amplitude 4.000 Vpp

Offset 0.000 Vdc

Pulse Width 100.000us

Rise Edge 10.0ns

Delay 50.0ns

Load HiZ

Output ON 

Frequency	Amplitude	Offset	PulWidth	Rise	Delay
Period	HighLevel	LowLevel	Duty	Fall	

To Generate a Noise Waveform

The generator can be set to output a noise waveform with an adjustable Stdev and Mean. The following steps show you how to generate a noise waveform with 500 mV Stdev and 1 mV Mean.

1. Select the Noise function

Press **Waveforms** → **Noise** to select the noise function and output a noise waveform with the default parameters.

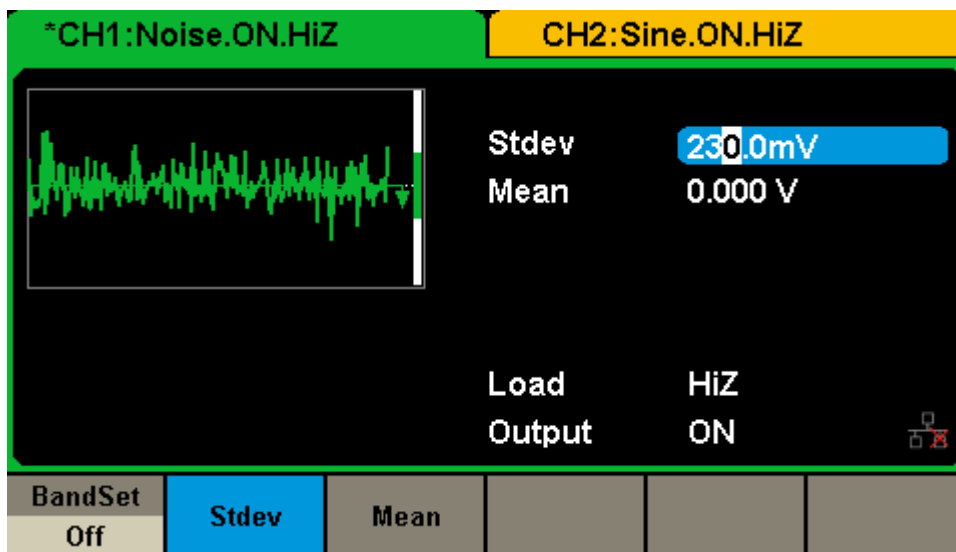

2. Set the Stdev

Press the **Stdev** softkey and then set the Stdev to 500 mV.

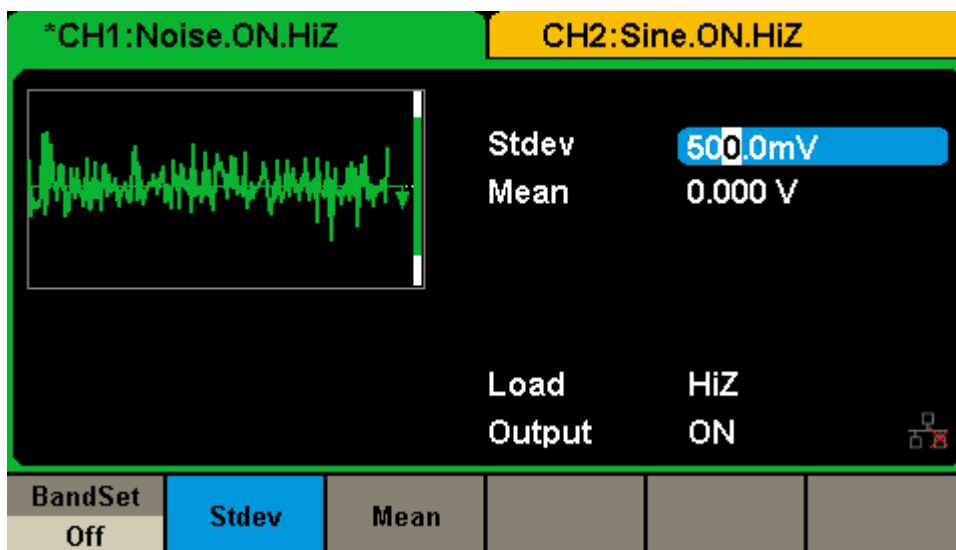

3. Set the Mean

Press the **Mean** softkey and then set the mean to 1 mV.

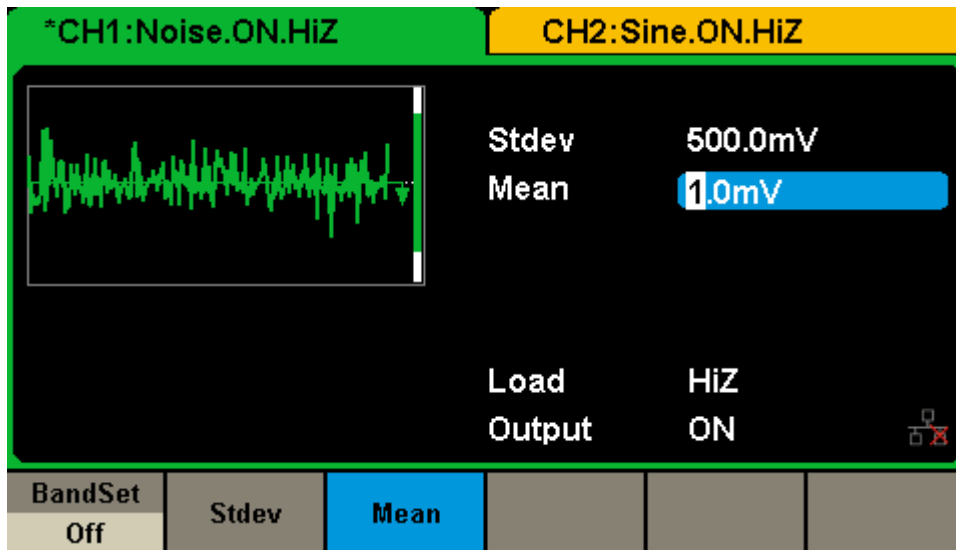

To Set the DC Voltage

The following steps show how to set a dc voltage with +1 Vdc.

1. Select the DC function

Press **Waveforms** → **Page 1/2** → **DC** to select the DC function.

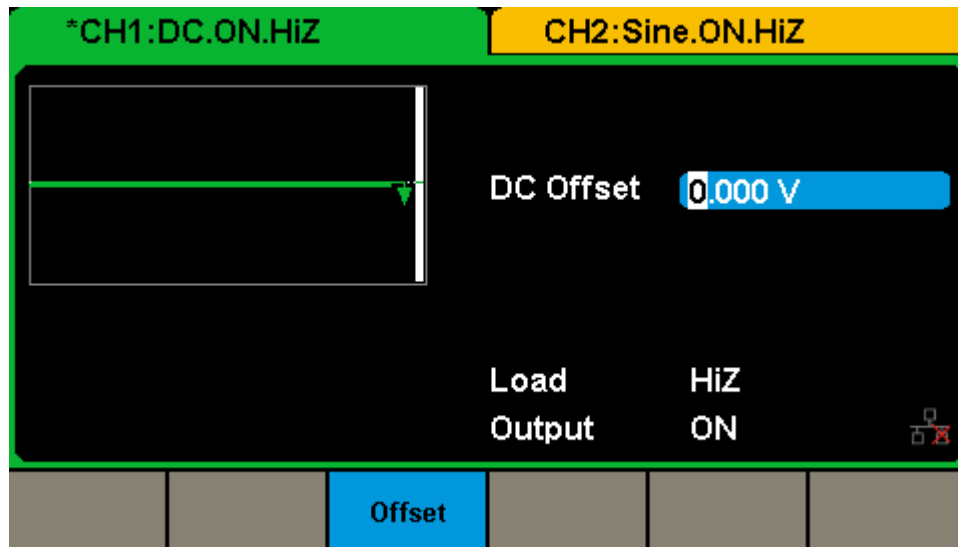

2. Set the DC Offset

Use the digital keypad to input the value directly, enter the value "1".

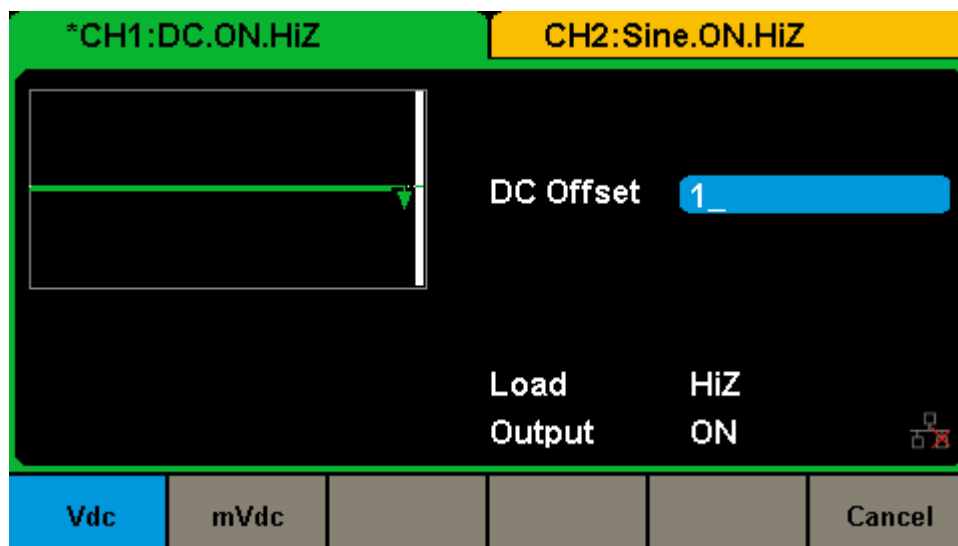

Then press the corresponding softkey to select the desired unit. For example, press **Vdc**.

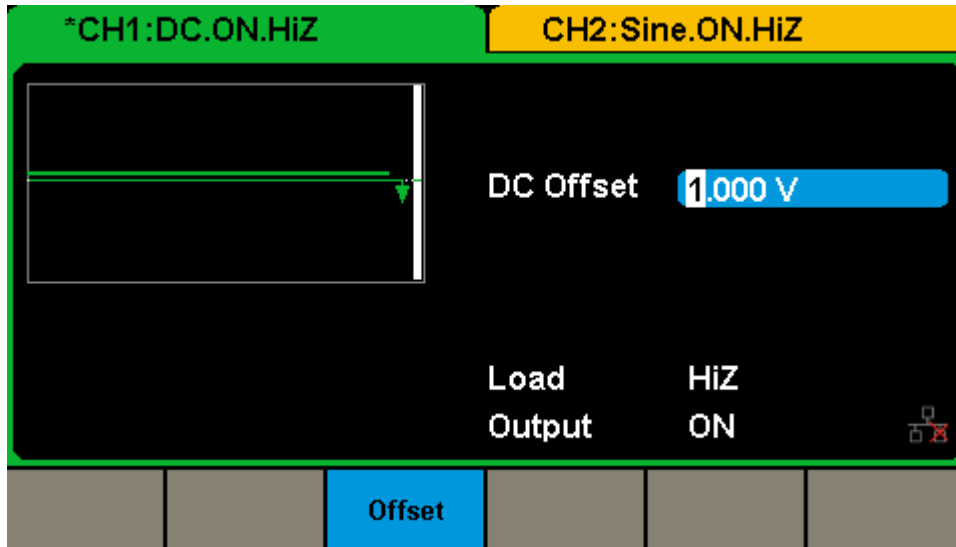

To Output a Built-In Arbitrary Waveform

There are approximately 200 built-in arbitrary waveforms stored in non-volatile memory. The following steps show how to output the built-in “exponential fall” waveform from the front panel.

1. Set the arbitrary waveform function

Press **Waveforms** → **Page 1/2** → **Arb Type** → **Built-In** to enter the arbitrary waveform setting interface.

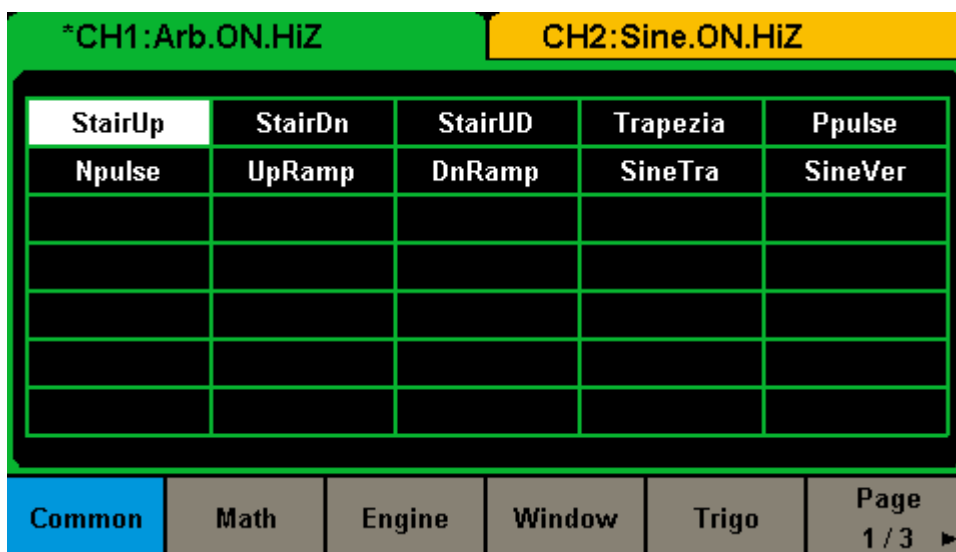

2. Set the Math waveform

Press the **Math** softkey to display the mathematic waveform as below.

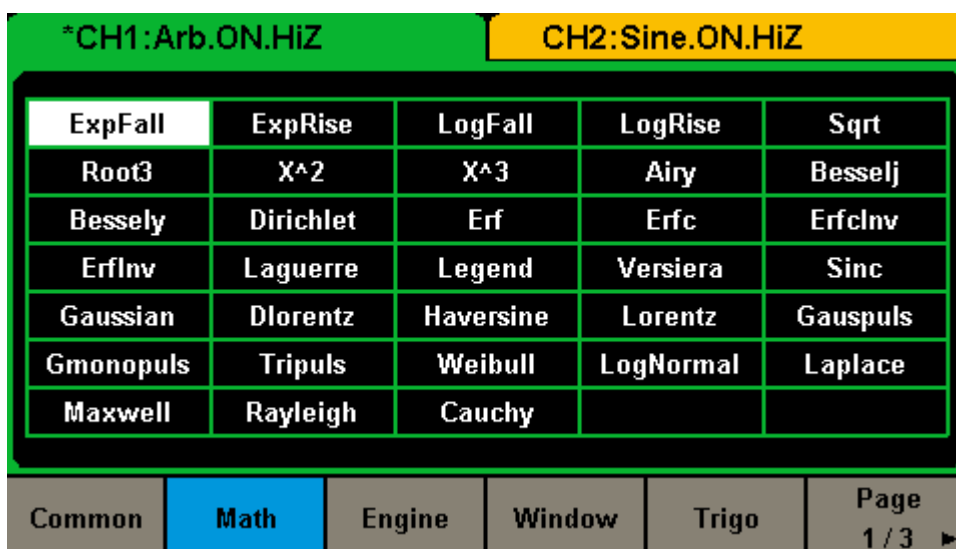

3. Output the exponential fall waveform

Rotate the knob to select the ExpFall waveform and press the knob. The waveform is output with the present settings unless they are changed.

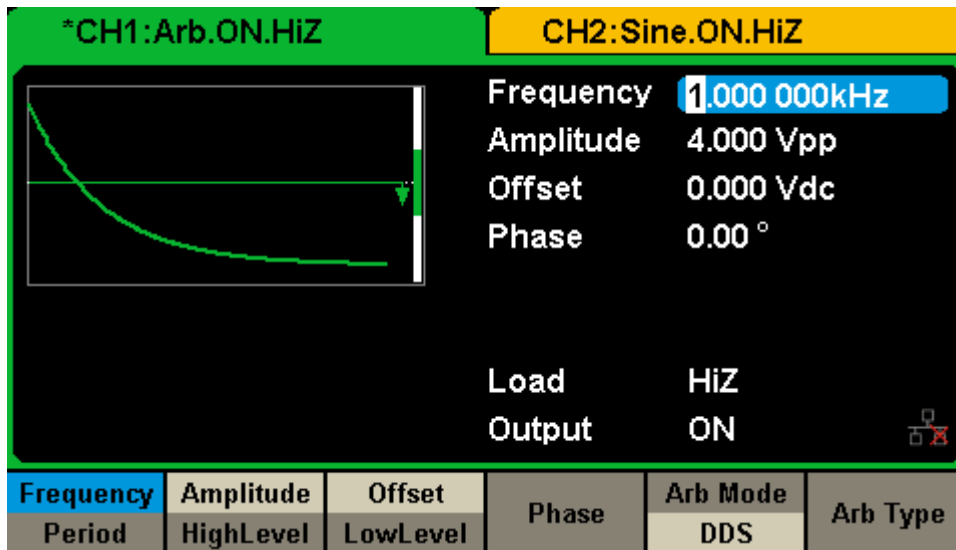

To Use the Built-In Help System

The built-in help system is designed to provide context-sensitive assistance of some functions. A list of help topics is also available to assist you with several operations.

1. Read the help information

Press **Utility** → **System** → **Page 1/2** → **Help** to enter the following interface. You will see a list of help topics as below. Use Up and Down keys, then press Select to choose a Help topic.

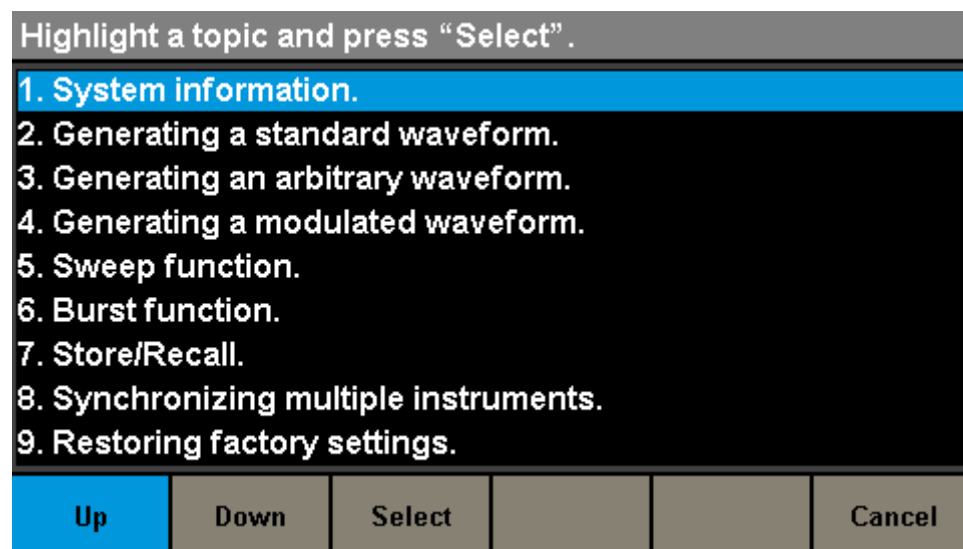

2. Press "Cancel" or any function button to exit the help system

Chapter 3 Calibration

This calibration procedure contains performance verification procedures and adjustment procedures. After receiving a generator, it is recommended to first confirm that the performance is related to the specifications. If so, then perform the appropriate adjustments.

Calibration Interval

The instrument should be calibrated on a regular interval determined by the measurement accuracy requirements of your application. A 1-year interval is adequate for most applications. Accuracy specifications will remain valid only if adjustment is made at regular calibration intervals. Accuracy specifications are not valid beyond the 1-year calibration interval. SIGLENT does not recommend extending calibration intervals beyond 2 years for any application.

Adjustment is Recommended

Specifications are valid only within the period from the last adjustment. Whatever calibration interval you select, **SIGLENT** recommends that re-adjustment should always be performed within the calibration interval. This is necessary to ensure the accuracy of the performance data measured during the calibration interval.

Automating Calibration Procedures

The complete verification and adjust procedures can be automated with the use of appropriate automated test instrumentation. The complete instrument configurations specified for each test may be programmed via the remote interface. Verification data can then be read-back from the instrument into a test program and compared to the appropriate test limit values.

The instrument can also be adjusted from the remote interface. Remote adjustment is similar to the local front-panel procedure. A PC can be used to perform the adjustment by first selecting the required function and range. The adjustment command is sent to the instrument and then the adjustment is initiated over the remote interface.

Recommended Test Equipment

The test equipment instrumentation recommended for the performance verification and adjustment procedures is listed below. If the exact instrument

is not available, substitute with the instrument of equivalent accuracy.

Instrument	Requirements	Recommended Model
Digital Multimeter (DMM)	DC volts accuracy: 100 ppm resolution: 100 μ V	Agilent 34401A
Power Meter	Frequency: 10 KHz to 50 MHz	Agilent U2004
GPIB cable		GPIB(IEEE488)
Frequency Counter	Accuracy: 0.5 ppm	

Test Considerations

For optimum performance, all procedures should comply with the following recommendations:

- Updating SDG's firmware to the newest version is strongly recommended.
- Assure that the calibration ambient temperature is stable and between 18°C and 28°C. Ideally, the calibration should be performed at 23°C \pm 1°C.
- Assure ambient relative humidity is less than 80%.
- Allow a 30 minute warm-up period before verification or adjustment.
- Keep the measurement cables as short as possible, consistent with the impedance requirements.
- Use a 50 Ω coaxial cable.

Performance Verification Test

The performance verification tests are recommended as acceptance tests upon receipt of the instrument. The acceptance test results should be compared against the specifications given in chapter 1. After acceptance, repeat the performance verification tests at every calibration interval.

If the instrument fails performance verification, adjustment or repair is required.

DC Output Verification

This test checks if the DC offset listed in the table below are within the spec range using a DMM.

1. Set the DMM to measure DC voltage. Connect the DMM to the CH1 output of the generator as shown below.

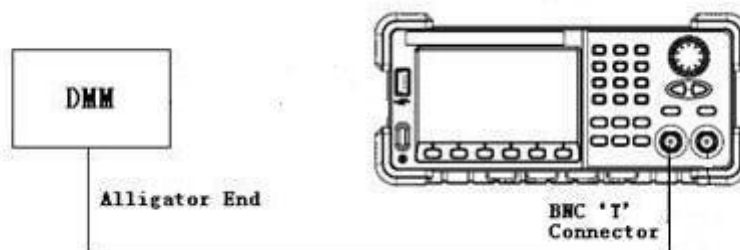

2. Turn on CH1 and select the DC waveform.
3. Set the instrument to each output value described in the table below and measure the output voltage with the DMM. Be sure the generator output load is set to High-Z and the output is enabled.

DC Offset	CH1	CH2	Spec Range $\pm (1\%+2 \text{ mV})$
0 mV			-2 mV ~ 2 mV
10 mV			7.9 mV ~ 12.1 mV
100 mV			97 mV ~ 103 mV
1 V			0.988 V ~ 1.012 V
3 V			2.968 V ~ 3.032 V
10 V			9.898 V ~ 10.102 V
-10 mV			-12.1 mV ~ -7.9 mV
-100 mV			-103 mV ~ -97 mV
-1 V			-1.012 V ~ -0.988 V
-3 V			-3.032 V ~ -2.968 V
-10 V			10.102 V ~ -9.898 V

4. Compare the measured voltage to the spec range shown in the table above.

AC Amplitude Verification

This test checks the ac amplitude output accuracy at the frequency of 10 kHz using a DMM.

1. Turn on the generator and choose CH1 as the operating channel. Set the Load to 50 Ω .
2. Connect the DMM and generator as shown below.

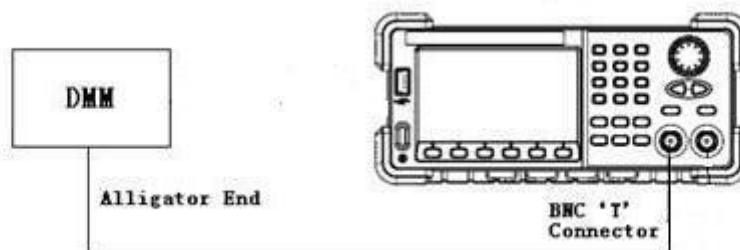

3. Select Sine waveform of the generator and set the amplitude to the values listed below in sequence.

Amplitude (V)	CH1 (V)	CH2 (V)	Spec Range (V) $\pm (1\%+1 \text{ mV})$
11			10.889~11.111
5.6			5.543~5.657
2			1.979~2.021
0.9			0.89~0.91
0.4			0.395~0.405
0.142			0.13958~0.14442
0.064			0.06236~0.06564
0.022			0.02078~0.02322
0.01			0.0089~0.0111
0.004			0.00296~0.00504

4. Remove the BNC cable to CH2 output and perform the same verification as CH1.
5. Compare the value measured from the DMM to the spec range shown in the table above.

Frequency Response Verification

This test checks if the amplitude flatness is within the spec range using a Power Meter.

1. Turn on the generator and choose CH1 as the operating channel. Set the Load to 50 Ω .
2. Connect the Power Meter, PC and generator as shown below.

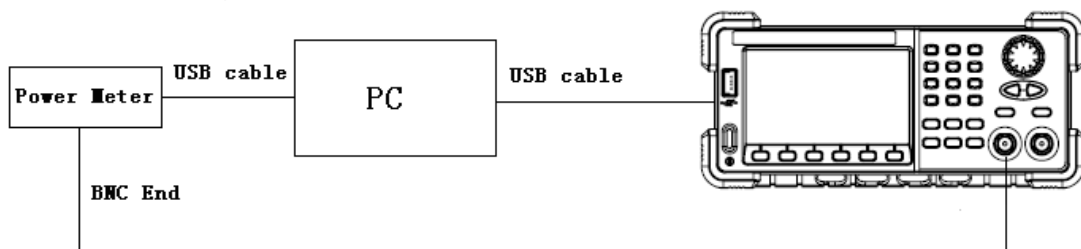

3. Select Sine waveform of the generator and set the amplitude to 1 V and 2.5 V, frequency to the values listed below in sequence.

Output Voltage	1 V			2.5 V		
	CH1	CH2	Spec Range (dBm)	CH1	CH2	Spec Range (dBm)
10 KHz			3.6794 ~ 4.2794			11.64 ~12.24
100 KHz			3.6794 ~ 4.2794			11.64 ~12.24
1 MHz			3.6794 ~ 4.2794			11.64 ~12.24
5 MHz			3.6794 ~ 4.2794			11.64 ~12.24
10 MHz			3.6794 ~ 4.2794			11.64 ~12.24
20 MHz			3.6794 ~ 4.2794			11.64 ~12.24
30 MHz			3.6794 ~ 4.2794			11.64 ~12.24
50 MHz			3.6794 ~ 4.2794			11.64 ~12.24
80 MHz			3.6794 ~ 4.2794			11.64 ~12.24
100 MHz			3.6794 ~ 4.2794			11.64 ~12.24
110 MHz			3.5794 ~ 4.3794			11.54 ~12.34
120 MHz			3.5794 ~ 4.3794			11.54 ~12.34

4. Remove the BNC cable to CH2 output and perform the same verification as

CH1.

5. Compare the value measured from Power Meter to the spec range shown in the table above.

General Adjustment Procedure

The following explains how to adjust the SDG2000X series generator for optimum operating performance.

- **Channel Adjustment** which includes four steps: feedback channel adjustment, channel self adjustment, vertical accuracy calibration and frequency counter calibration.
- **Feedback Channel Adjustment** which acts as a standard calibration module, providing the accuracy assurance for Self Adjust.
- **Channel Self Adjustment** which includes internal control channel adjustment and signal channel adjustment.
- **Vertical Accuracy Calibration** which calibrates the amplitude at low frequency.
- **Frequency Counter Calibration** which calibrates the trigger level of the counter.
- **Frequency Response Adjustment** which could properly compensate the amplitude as the frequency increases.
- **TimeBase Calibration** which calibrates the output frequency accuracy.

Software Environment

1. Python

Make sure you have installed Python 2.7 in your computer. The following modules of Python are required as well: PyVISA, PyQt4 and PyWin32.

2. Microsoft Office

As test reports are saved as '.xls', it is necessary that you are working with MS Office 2003 or higher version.

3. NI VISA

The Python module, PyVISA, is based on VISA I/O library which can be derived from NI VISA.

Warming up

Before performing the adjustment procedures, let the generator and other test equipment warm up for at least 30 minutes in an ambient temperature between 18 °C and 28 °C. Adjustments performed prior to warm-up or outside this temperature range may result in poor performance.

Channel Adjustment

The channel adjustment includes four parts: feedback channel adjustment, channel self adjustment, vertical accuracy calibration and frequency counter calibration.

1. Turn on the generator.
2. Connect the DMM, PC and SDG2000X generator as shown below:

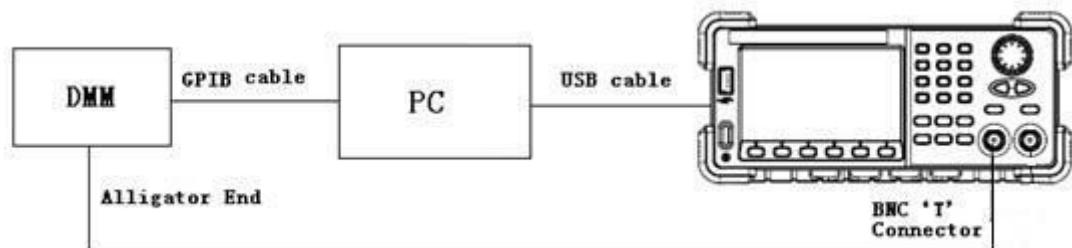

3. Double click and run the script ChannelAdjust.py prepared previously. Then Change the channel connection according to the prompt message.

Note:

If there is a problem in the process of the channel adjustment, you can separately perform the four parts mentioned above. After the feedback channel adjustment has been completed, perform a self adjustment. Then perform the vertical accuracy calibration and frequency counter calibration in turn.

Feedback Channel Adjustment

The internal feedback channel receives the feedback signal from all the other channels that are performing self adjustment. This adjustment acts as a standard test module and must be performed prior to Self Adjust to make sure it is performed based on the best adjusting accuracy.

1. Connect the DMM, PC and SDG2000X generator as shown below:

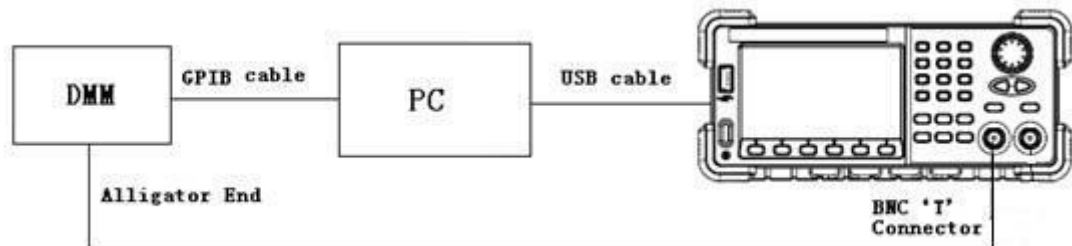

2. Double click and run the script **FeedbackAdjust.py** prepared previously. The CH1 will be automatically turned on upon running of the script.

Channel Self Adjustment

This adjustment is for internal control channel and signal channel. Through feedback circuits of the feedback channel and signal channel, this adjustment helps to obtain the actual working performance for components from signal channels.

1. After the feedback channel adjustment completed, disconnect the two BNC cables on CH1 and CH2.
2. Input the password “123654” under the system info interface to show the SelfCal menu and perform the self adjustment.
3. Once the “Self Adjust” begins, the generator turns to adjustment interface and the progress bar displays on the screen. In about 20 seconds it will reach 100%, which indicates completing of the self-adjust. The progress bar will disappear automatically after 2 seconds.

Vertical Accuracy Calibration

This adjustment aims to calibrate the amplitude at low frequency, using a DMM with high precision. The SDG2000X begins this portion of the calibration after the completion of the self adjustment. It calibrates the Sine wave with a 10 kHz frequency and selects several amplitudes to calibrate. Compare the measured amplitude and the standard to obtain a set of compensation values.

1. Connect the DMM, PC and SDG2000X generator as shown below:

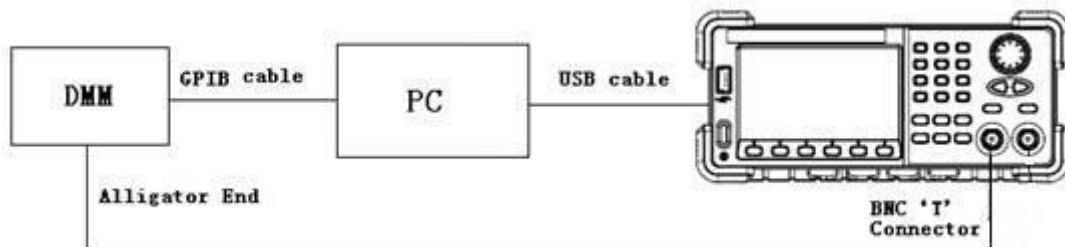

2. Double click and run the script **VertAccCalib.py** prepared previously.
3. Change the channel connection according to the prompt message.

Frequency Counter Calibration

This adjustment aims to calibrate the trigger level of the counter to obtain more accurate measured values.

1. Connect the PC and SDG2000X generator with a USB cable and connect the CH1 at the front panel to the counter port at the rear panel with a BNC cable, as shown below:

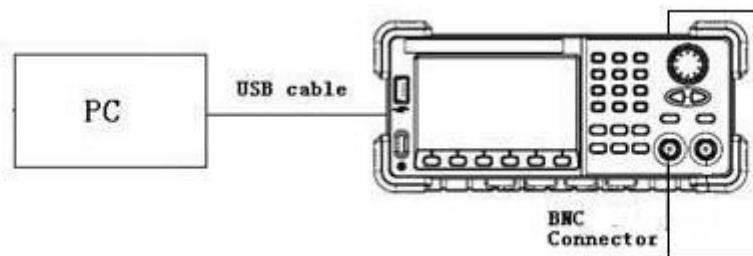

2. Double click and run the script **FreqCounterCal.py** prepared previously.

Frequency Response Adjustment

This adjustment aims to obtain the actual frequency response characteristics of the signal channel, thus to perform appropriate compensation. Since the waveform amplitude will decrease as the input frequency increases, it is essential to compensate for the amplitude to match it to the frequency. This adjustment should be performed after the channel adjustment.

1. Turn on the generator and connect it to the PC using a USB cable.
2. Connecting the USB end of the Power Meter to the USB port of the PC, upon which the Power Meter indicator light will be brightened. Only after the indicator light goes out from red, should it be connected to the generator output.

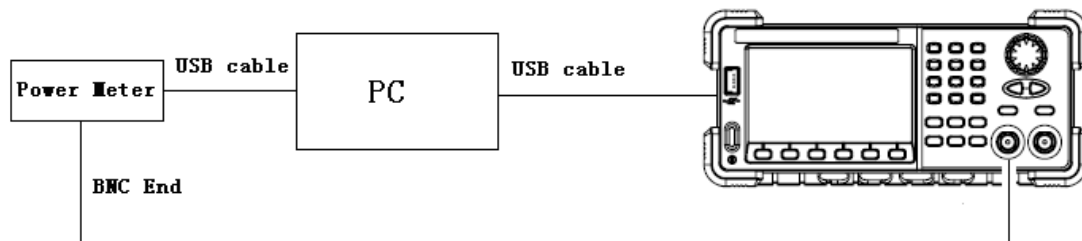

3. Run the script **FrqRespCalib.py** prepared previously. In approximately 10 seconds the prompt message will display on the screen to indicate the operator to connect the Power Meter. After the generator completes the adjustment for CH1, the prompt message displays on the screen will prompt the operator to remove the BNC cable to CH2 to start adjustment.
4. After the two channel adjustment completed, please disconnect all the connections.

TimeBase Calibration

This adjustment aims to calibrate the output frequency accuracy through adjusting the DAC code.

1. Connect the counter port at the SDG2000X's rear panel to a high accuracy 10 MHz signal with a BNC cable, as shown below:

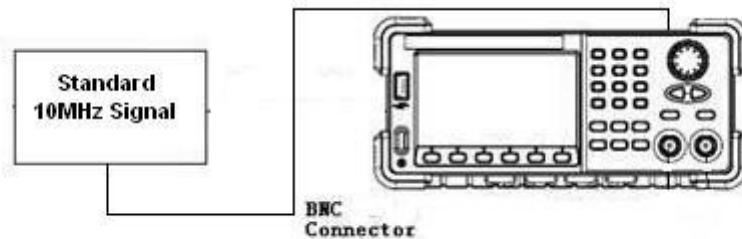

2. Press **Utility** button on the front panel and select **System** → **Page 1/2** → **System Info**. Use the number keyboard to input "123654". Then select the **TimeBase Calibration** softkey. The timebase calibration interface is shown as the following.

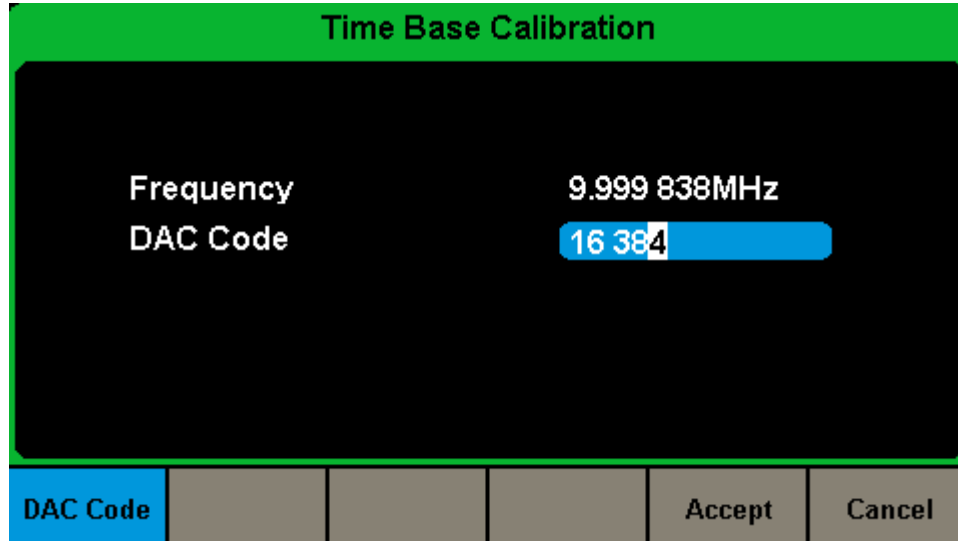

3. Use the numeric keyboard or knob to adjust the DAC code to make the measured frequency to be closer to 10 MHz.

Chapter 4 Assembly Procedures

This chapter describes how to remove the major modules from the SDG2000X series generator. To install the removed modules or replace new modules, please follow corresponding operating steps in reverse order.

The following subjects are addressed in this chapter:

- **Security Consideration** which describes security information needed to considerate while operating.
- **List of Module** in which the modules to remove are listed.
- **Required Tool** which describes the tools needed to perform the procedures
- **Disassembly Procedures** which describes in detail how to remove and install the modules

Security Consideration

Only qualified personnel should perform the disassembly procedures. Whenever possible, disconnect the power before removing or replacing. Otherwise, personal injuries or damages to the components may occur.

Avoid Electric Shock Hazardous voltages exist on the LCD module and power supply module. To avoid electrical shock, disconnect the power cord from the generator, and then wait at least three minutes for the capacitors in the generator to discharge before beginning the disassembly.

Preventing ESD Almost all electrical components can be damaged by electrostatic discharge (ESD) during handling. Component damages can occur at electrostatic discharge voltages as low as 50 volts. The following guidelines will help preventing ESD damage when servicing the instrument or any electronic device.

- ◆ Disassemble instruments only in a static-free work area.
- ◆ Use a conductive work area to reduce static charges.
- ◆ Use a conductive wrist strap to reduce static charge accumulation.
- ◆ Minimize handling.
- ◆ Keep replacement parts in original static-free packaging.

- ◆ Remove all plastic, foam, vinyl, paper and other static-generating materials from the immediate work area.
- ◆ Use only anti-static solder suckers.

List of Modules

The following removable modules are listed in the order of performing disassembly procedures.

Number of Module	Module
1	Handle
2	Metal Shell and Rear Cabinet
3	Front Cabinet
4	Display Module
5	Main Body

Required Tools

Use these tools to remove or replace the modules in the generator:

- T10 and T15 Torx screwdriver

Disassembly Procedures

This section describes how to remove and install the generator's modules listed above in detail. Complete disassembly will be best achieved through the following operating steps.

1. Pull out the handle hard from the two sides of the generator.

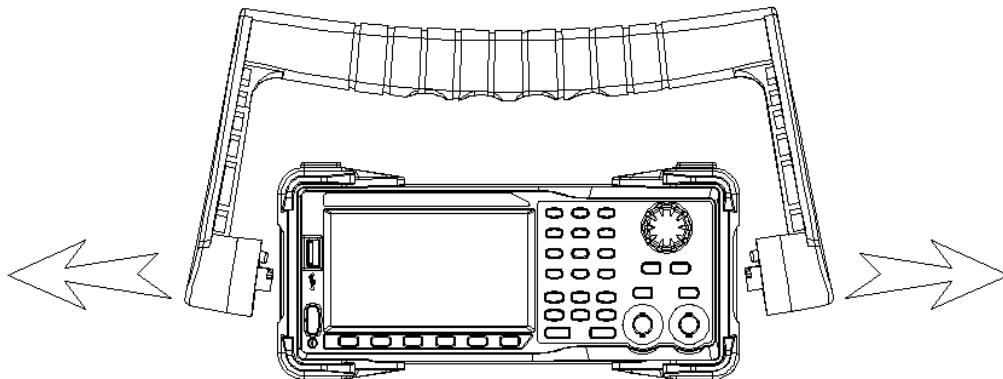

2. After removing 4PCS screws of the pad and 1PCS screw at the bottom of the generator's case, remove the metal shell carefully from the main body to avoid being scratched.

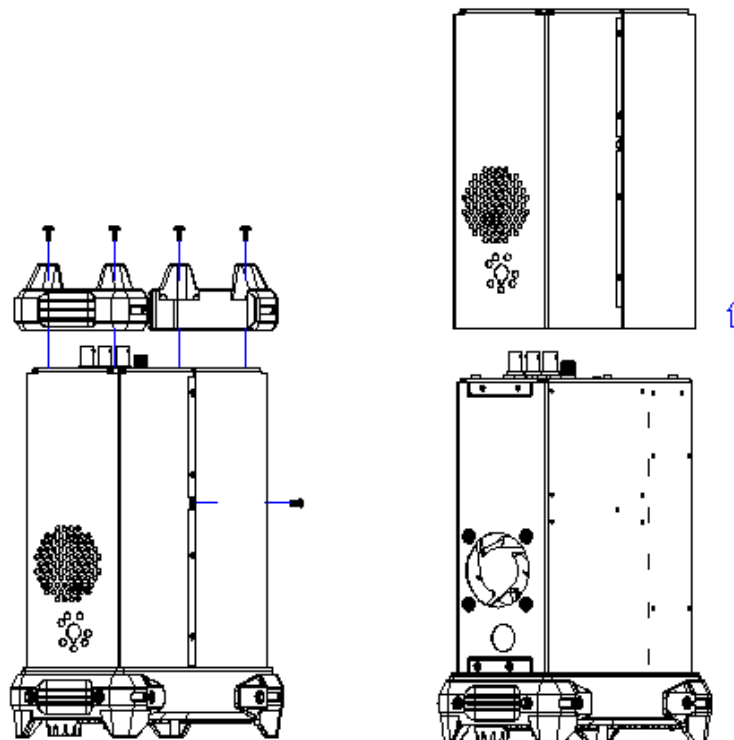

- Open the cable clamp as ①② show and pull out the cable as ③④⑤⑥ show, and then remove the 5PCS screws as shown in the following figure.

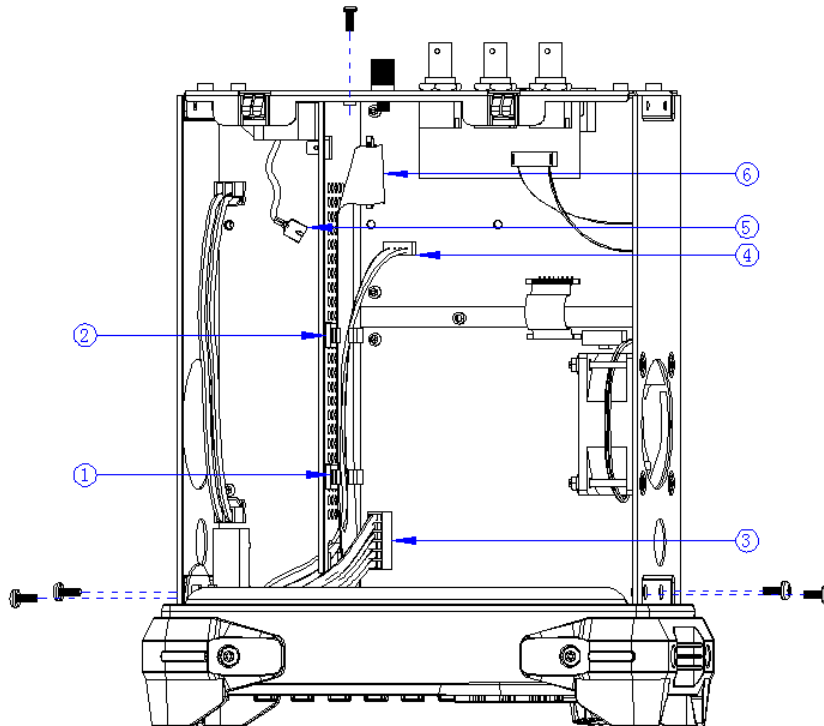

- Separate the front panel from the main body of the generator.

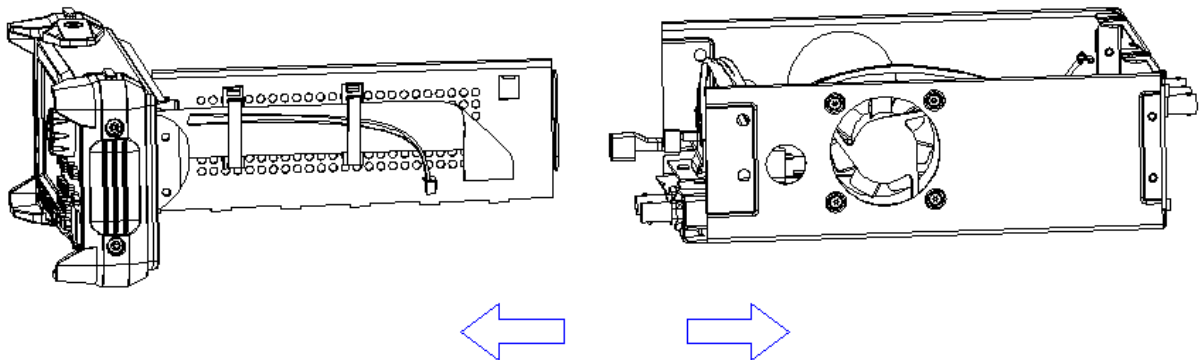

- Pull out the knob and then remove the screws attaching the hardware partition plate and the front cabinet screws.

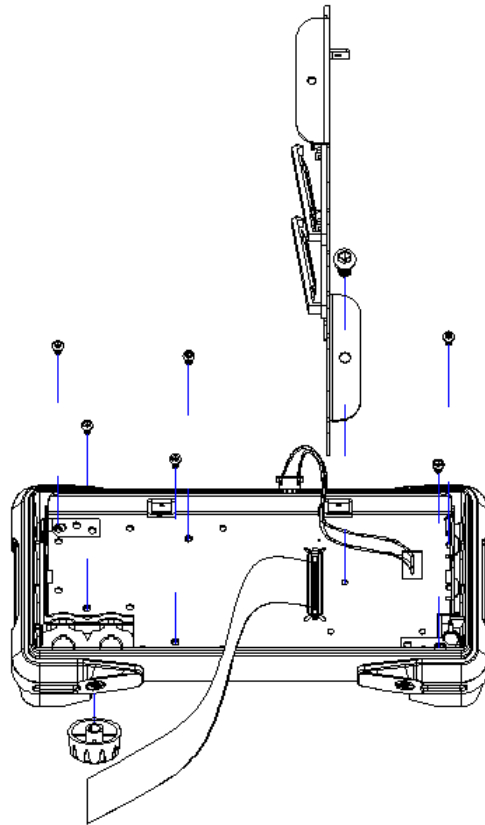

6. Remove the keypad circuit board assembly.

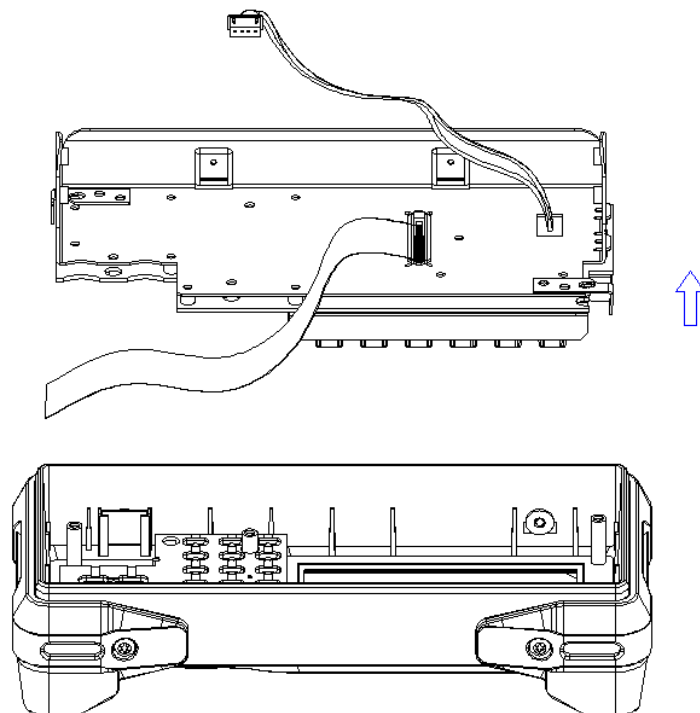

7. Remove the 3PCS screws holding the screen bracket and remove the

metal front panel.

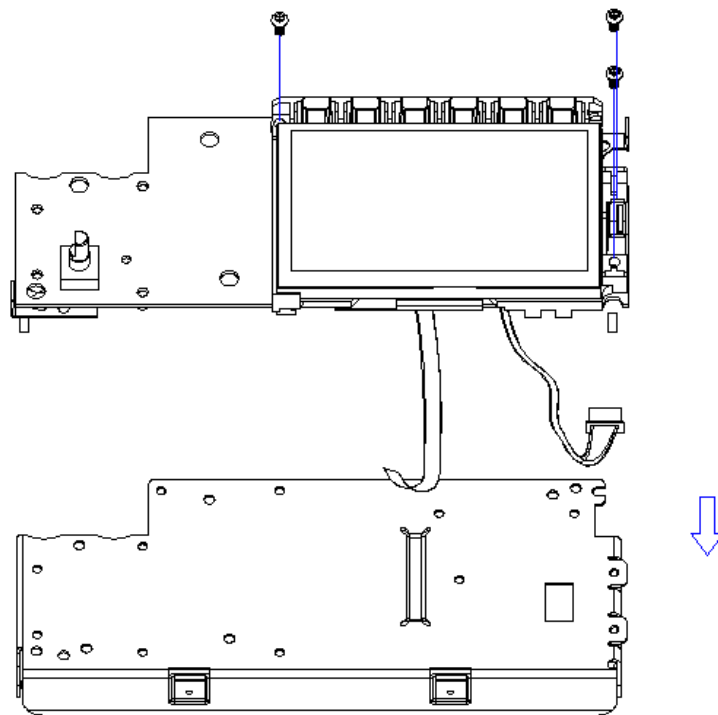

8. Pull out the connecting cable according to the index number as shown in the following figure and remove the keyboard.

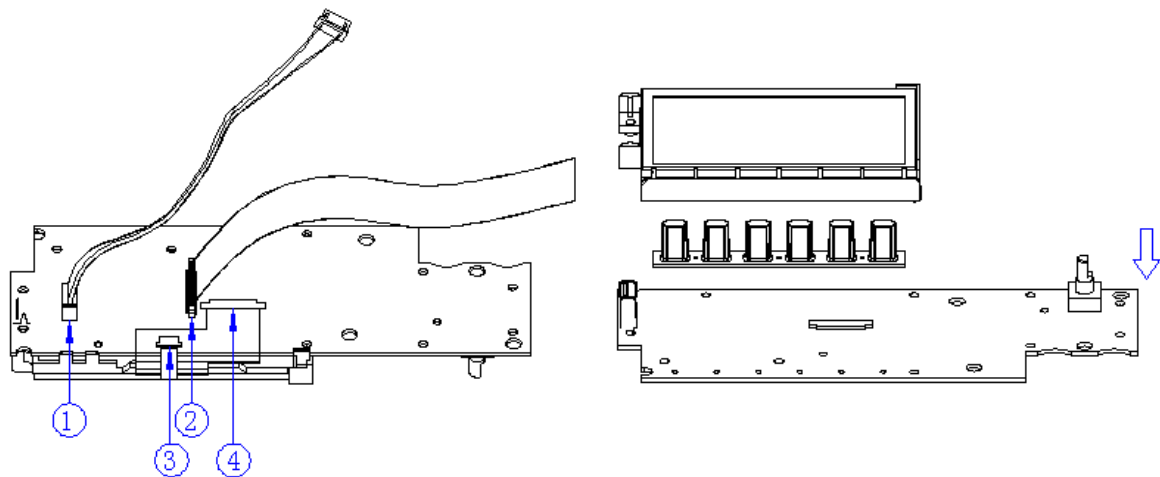

9. Remove all the 9 screws fixed the main board and power supply board using the T10 Torx screwdriver and separate the main board and power supply board carefully from the main body of the generator to avoid being scratched by the sharp metal edge.

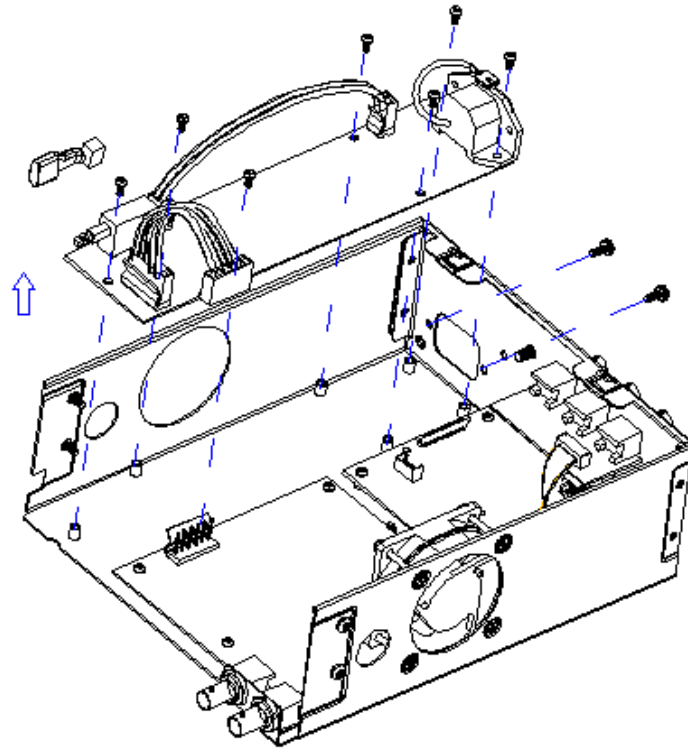

10. Pull out the connecting cable as shown in the following figure and then remove the fan, rear interface board, channel board and main board.

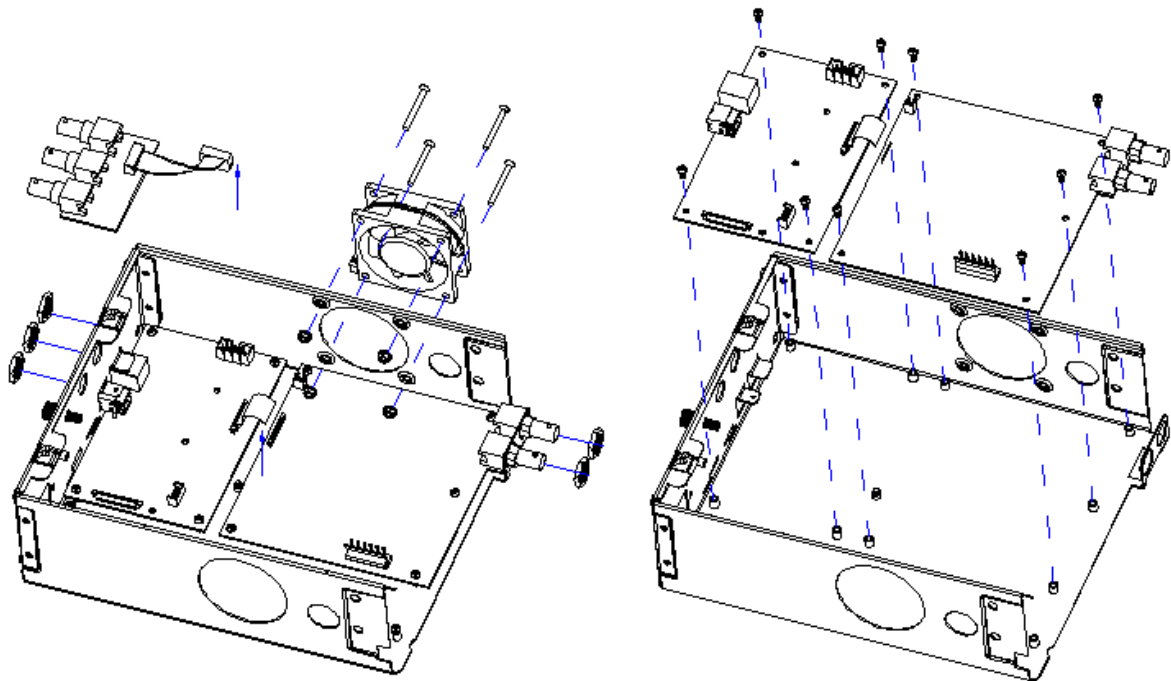

Note:

To assemble the generator, please follow these same steps in reverse order.

Chapter 5 Troubleshooting

The internal structure of the generator consists of the main board, channel board, power supply board, key and LCD board, and interface board. They are linked through cables or connectors. This chapter explains the main troubleshooting procedures for these boards (mainly main board and channel board) by measuring the corresponding test points and checking the signals of connectors on them, thus to help in determining the reason for the failure that has been encountered while operating the SDG2000X series arbitrary waveform generator.

ESD Precautions

While performing any internal test of the generator, please refer to the following precautions to avoid damages to its internal modules or components resulting from ESD.

- Handle circuit boards by their edges as much as possible.
- Avoid handling of static-sensitive modules if not necessary.
- Wear a grounded antistatic wrist strap to drain the static voltage from your body while touching these modules.
- Operate static-sensitive modules only in static-free areas. Avoid handling modules in areas that allow anything capable of generating or holding a static charge.

Required Equipments

The equipment listed in the table below is required to troubleshoot the generator.

Table 5-1 Required Equipments

Equipment	Critical Specifications	Example
Digital Multimeter	DC Accuracy $\pm 0.015\%$	SDM3055

Oscilloscope	300 MHz Bandwidth	SDS2304X
--------------	-------------------	----------

Main Board Drawing

The main board is the control center of the generator that contains an ARM CPU system. It completes the GUI function, controlling and configuration function of the channel board as well as the user interface. Please refer to the following drawing to quickly locate the test points on the main board for easy resolution of any problems encountered.

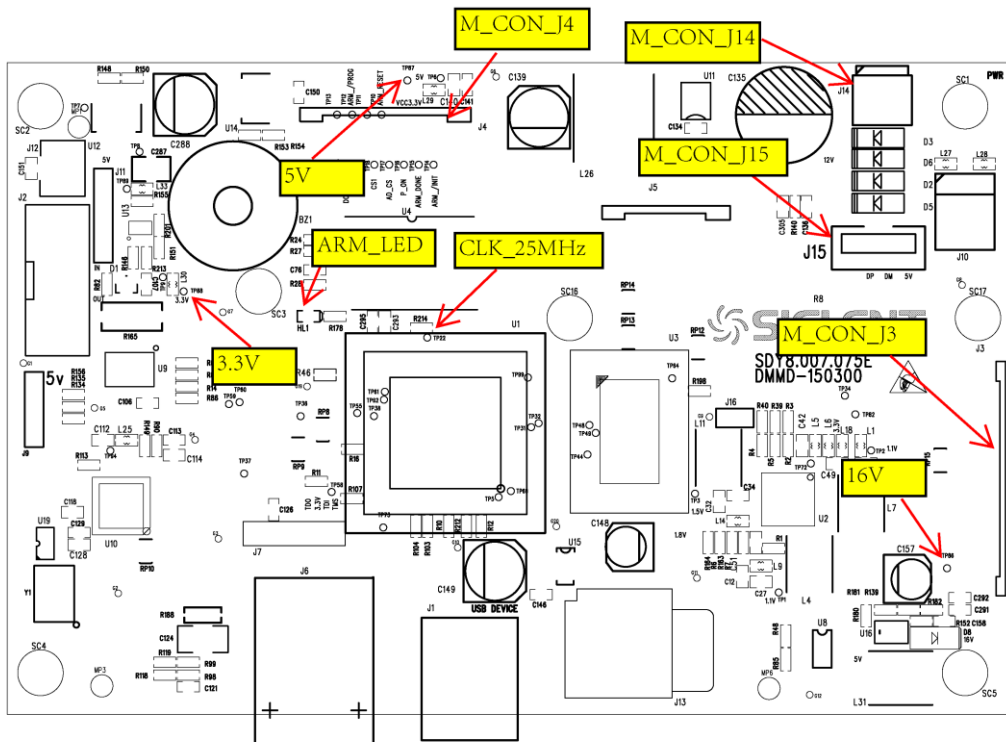

Check the Power Supply

There are two power connectors through which the channel board and main board can be supplied power.

Before performing the power supply testing procedure, please make sure that the generator is grounded correctly through the protective lead of the power cord. Take care not to touch or even disassemble the power supply module without any safety precautions, electric shock could occur. Here are procedures for testing the power supply:

1. Disconnect the power cord of the generator and then check whether the fuse is good.
2. Remove metal shell of the generator, and then disconnect the power connector connected to the main board.
3. Focus on the Power Connector for channel board, which contains 6 pins from Pin 1 to Pin 6. Since two of the six pins are ground wire, test the other four pins that are marked with blue, yellow, red and white to check whether the voltage value is within the corresponding specified range using a digital multimeter. The voltage parameters to be tested are listed in the table below:

Table 5-2 Test Voltages of Power Connector

Voltage value	Pins	Error limit
20 V	VH+(red)	±10%
-20 V	VH-(white)	±10%
6.5 V	VL+(yellow)	±10%
-6.5 V	VL-(blue)	±10%

If each tested voltage value is within the corresponding specified range listed in the table above, then the power supply is working normally. Otherwise, please go to step 4.

4. Disconnect the power connector and redo step 3. Because of the removal of the load, each voltage value error limit increases by approximately 20 percent.

Table 5-3 Test Voltages of the Connector After Disconnected

Voltage value	Pins	Error limit
20 V	VH+(red)	±30%

-20 V	VH-(white)	±30%
6.5 V	VL+(yellow)	±30%
-6.5 V	VL-(blue)	±30%

If each tested voltage value is within the specified range listed in the table above, then some abnormality of the load is most likely causing the power supply problem. Continuous checking or even replacing the channel/main board is required for further test.

If there is at least one voltage value that is out of the specified range, then the power supply module appears to be problematic, and a replacement will be required. For safety, please have qualified technical personnel to disassemble the power supply module.

Note: *The main power supply provides an input fuse to protect against the danger of fire in the event of a failure of the power supply circuitry. However, this fuse will not fail ("open" or "blow") in normal power supply operation except when a significant overload occurs. Replace the entire main power supply assembly if the input fuse fails.*

Check the Channel Board

If it is desired to remove the channel board from the metal shelf inside the generator, please place it on a clean, insulated mat. Here are the procedures for testing the main board:

1. Several types of connectors are used on the channel board. Check to make certain that all of these are connected properly.
2. After checking these connectors, then connect the generator to AC power and power it on. Check if the voltage values at all test points are within the specified range using a digital multimeter. The voltage parameters to be tested are listed in table 5-4:

Voltage Checking

Test the voltage points on the channel board in the table below. To locate the test points, please refer to the drawing of the channel board. If not each tested voltage value is within the corresponding spec range referring to table 5-4, it proves to be faulted, please return it to the factory to have it repaired or contact SIGLENT.

Table 5-4 Test Voltages of the Channel Board

Test point	Voltage value	Error limit
+15 V	+15 V	±5%
-15 V	-15 V	±5%
-5 V	-5 V	±5%
+5 V	+5 V	±5%
VCC1.8 V	+1.8 V	±5%
VCC3.3 V	+3.3 V	±5%
VCC2.5 V_A	+2.5 V	±5%
VCC2.5 V_B	+2.5 V	±5%
VCC1.5 V	+1.5 V	±5%
VCC1.1 V	+1.1 V	±5%
PLL_3.3 V	+3.3 V	±5%

10 MHz Clock Source Checking

There is a TXCO generating a 10 MHz 3.3 V LVCOMS clock source to the entire channel board. Please check it, referring to the marked point on the channel board drawing.

FPGA Checking

To check if the FPGA is working properly, please observe the test point marked with FPGA_LED on the channel board drawing. The LED light flashes at the rate of 1Hz in normal case, if it cannot be lighted or twinkles at incorrect frequency, then the FPGA may be at fault.

Connector Checking

Table 5-5 Connectors of the Channel Board

Connector	Function
CON_J1	Communication between the main board and the channel board.
CON_J5	Communication between the channel board and the interface board.
CON_J6	Power supply of the channel board.
CON_J7	Power supply of the fan.

Table 5-5 explains the function of all the connectors on the channel board. It is important to ensure that all the connections are tight.

Check the Main Board

If the power board does need to be removed from the metal shelf located inside the generator, place it on a clean, insulated mat. Testing procedures for the main board are as follows:

1. Several types of connectors are located on the main board. Check if all these are connected properly.
2. Make certain that the connectors on the main board are properly connected, then connect the generator to AC power and turn it on. Check if the voltage values at all test points are within the spec range using a digital multimeter. The voltage parameters to be tested are listed in table 5-6:

Voltage Checking

Test the voltage points on the main board and compare to the table below. If each tested voltage value is within the corresponding specified range referring to the table below, then the main board works normally. If the voltages are out of the specified range, please return it to the factory to have it repaired or contact SIGLENT.

Table 5-6 Test Voltages of the Main Board

Test point	Voltage value	Error limit
16 V	16 V	±5%
3.3 V	3.3 V	±5%
5 V	5 V	±5%

Main Board Clock Checking

The main board clock is the internal system clock of the generator. To verify if the clock on the main board is working normally, please test the clock using an oscilloscope.

Table 5-7 Clock Source of the Main Board

Test point	Frequency	Stability	Level
CLK_25 MHz	25 MHz	±50 ppm	3.3 V LVCOMS

ARM CPU System Checking

Observe the ARM_LED light on the main board, which indicates the working state of ARM CPU system. If the light turns on, then the corresponding codes have been loaded successfully and the chip is in an operating state. Otherwise, there may be a problem with it.

Connector Checking

Table 5-8 Connectors of the Main Board

Connector	Function
M_CON_J3	Communication between the main board and the Key and LCD board.
M_CON_J14	Power supply of the main board.
M_CON_J4	Communication between the main board and the channel board.
M_CON_J15	USB host connector.

Table 5-8 explains the function of all the connectors on main board. It is important to ensure that all the connections are tight.

Quick Guide for General Failures

The general hardware failures are described in the following. Reading the following information can help in determining the cause of some general hardware failures:

1. No start-up after pressing the power button:

- (1) Check if the power cord is correctly connected.
- (2) Check if the power button is operating correctly..
- (3) Check whether the fuse has been burned out. If the fuse is blown, please replace with a fuse of the same rating
- (4) Check if the the connection between the power supply and the main board.
- (5) If the instrument still does not work normally, please contact SIGLENT.

2. Starts up with a dark screen:

- (1) Check the connection between the power supply and the main board.
- (2) Check the connection between the keypad circuit board and the main board.
- (3) If the instrument still does not work normally, please contact SIGLENT.

3. No response after pressing any button, or abnormal display of the screen:

- (1) Check the connection between the keypad circuit board and the main board.
- (2) If the instrument still does not work normally, please contact SIGLENT.

4. The output voltage amplitude measured is higher or lower than expected:

- (1) Check the connection between the generator and the load.
- (2) Check if the impedance set in generator matches the input impedance of the load.
- (3) If the instrument still does not work normally, please contact SIGLENT.

Chapter 6 Maintenance

Maintain Summary

SIGLENT warrants that the products it manufactures and sells are free from defects in materials and workmanship for a period of three years from the date of shipment from an authorized **SIGLENT** distributor. If a product proves defective within the respective period, **SIGLENT** will provide repair or replacement as described in the complete warranty statement.

To arrange for service or obtain a copy of the complete warranty statement, please contact your nearest **SIGLENT** sales and service office.

Except that as provided in this summary or the applicable warranty Statement, **SIGLENT** makes no warranty of any kind, express or implied, including without limitation the implied warranties of merchantability and fitness for a particular purpose. In no case shall **SIGLENT** be liable for indirect, special or consequential damages.

Repackaging for Shipment

If the unit needs to be shipped to **SIGLENT** for service or repair, be sure:

1. Attach a tag to the unit identifying the owner and indicating the required service or repair.
2. Place the unit in its original container with appropriate packaging material for shipping.
3. Secure the container with strong tape or metal bands.

If the original shipping container is not available, place your unit in a container which will ensure at least 4 inches of compressible packaging material around all sides for the instrument. Use static-free packaging materials to avoid additional damage to your unit.

Contact SIGLENT

SIGLENT TECHNOLOGIES CO., LTD

Address: 3/F, NO.4 building, Antongda Industrial Zone, 3rd Liuxian Road, 68th
District, Baoan District, Shenzhen, P.R. China

Tel: 400-878-0807

E-mail: sales@siglent.com

<http://www.siglent.com>

In North America: <http://www.siglentamerica.com>